

TC
Needle Holders
04

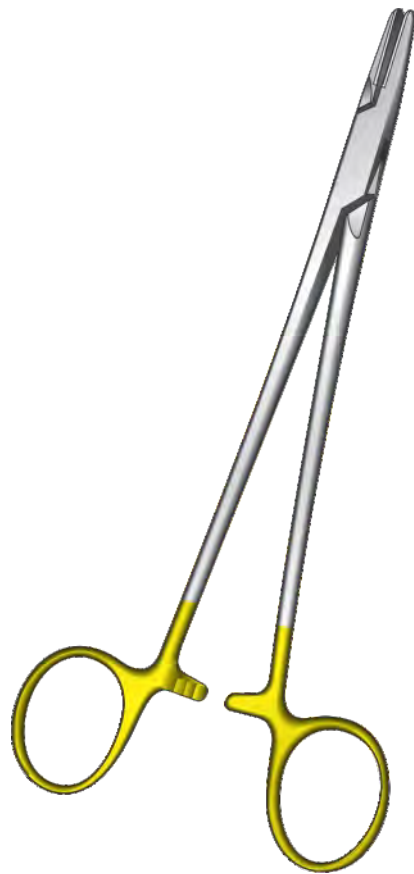

WELMED
INSTRUMENTS CO.

Arruga	14	Micro-Vascular	12, 22
Baby Crile-Wood	03	Mini-Ryder	25
Berry	31	Mobley-Webster	24
Boynton	14	Muller	17
Bozeman (wertheim)	18	Neivert	04
Bozeman-Finochietto	18	New Orleans	05
Bozemann	11	Olsen-Hegar	13, 24
Castroviejo	28, 29	Olsen-Webster	24
Cooley-Style	21	Original Debakey	08
Costatini	21	Par-Style	02
Crile-Wood Modif.	04	Pechlaner	34
Crile-Wood	03- 05	Pin Puller	34
Debakey Delicate	21	Pittmann	06
Debakey	10, 21	Rein	17
Dert	02	Rochester	22
Diethrich	25	Ryder	09
Double-Action	29	Ryder-Vascular	10
Eufrate-Pasque	27	Sarot	05, 21
Finochietto	06	Schacke	29
Flat Nose Plier	34	Smith	35
Foster-Gillies	13	Stratte Delicate	07
French Eye Delicate	26	Stratte Reverse	19
French Eye	26	Stratte	07, 19
Front & Lateral Cutter	37-39	Tessier	29
Gillies-Webster	13	Thorlakson	07
Halsey	02	Toennis Delicate	15
Heaney	05	Toennis	15
Hegar	12	Turner-Warwick	20
Hegar-Baumgartner	04	Universal Crile-Wood	23
Hegar-Vascular	11	Universal Debakey	23
Heger	32	Universal Halsey	23
Hellberg	17	Universal Mayo-Hegar	23
Hoesel	16	Universal	35
Hufnagel-Ryder	25	Wangensteen	11
Intracardiac	25	Webster	02
Julian-Style	21	Wire Cutters	36
Kalt	29	Wire Holding Forcep	30, 33
Kilner	02, 18	Wire Twisting Forceps	67, 68
Kirschner Wires Cutter	39		
Korkhaus	32		
Kremer	32		
Langenbeck	15		
Langenbeck-Ryder	15		
Leibinger	32		
Leibinger-Castroviejo	28		
Leibinger-Marberger	29		
Lemmon	22		
Lindorf	62		
Martin	06		
Martini	12		
Masson	09		
Masson-Luethy	18		
Mathieu	14, 16		
Mathieu-Eiselsbeg	16		
Mathieu-Kocher	14		
Mathieu-Ryder	14		
Mathieu-Style	31		
Mayo-Hegar	09		



- Wide selection of patterns for all facets of surgery with many WELMED INSTRUMENTS exclusive specialties
- five different Tungsten Carbide insert styles for needle and suture sizes up to 10-0.
- Precisely machined and handcrafted for longlasting performance
- gold-plated ring-handles for easy identification



Serrations: 0.5 mm - REGULAR

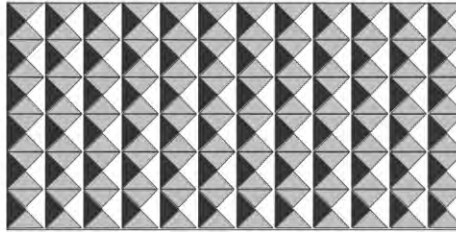

REGULAR

This tooth size is ideal for use in standard pattern needle holders like Mayo-Hegar, Mathieu, Bozeman a.o. And in needle-pulling tissue forceps. For holding large needles with sutures sized 3-0 and larger.

Serrations: 0.4 mm - FINE

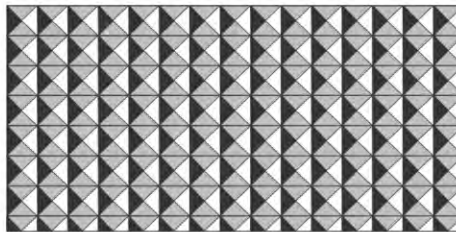

FINE

Best for use in needle holders such as Crile-Wood, DeBakey, Ryder, a.o. And in delicate needlepulling tissue forceps. For holding needles and sutures between 4-0 and 6-0.

Serrations: 0.65 mm - COARSE

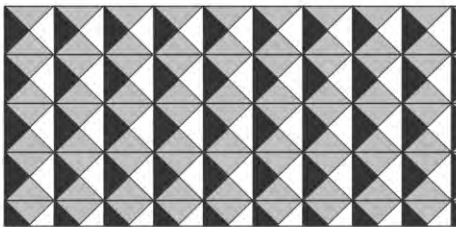

COARSE

This coarsely serrated insert is placed in the most powerful needle holder patterns and wire twisters and assures maximum holding ability when using heavy needles or surgical wire.

Serrations: 0.2 mm - MICRO

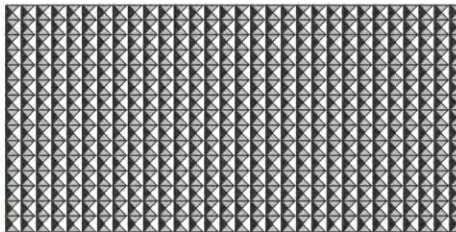

MICRO

This micro size is extremely effective for use in microsurgical needle holders like Castroviejo, Mini-Ryder, Microvascular, Lemmon and other microoriented needle holders. For use with the most delicate needles and sutures from size 7-0 to 10-0. Excellent delicate needle holding ability without minimal damage to needle or suture.

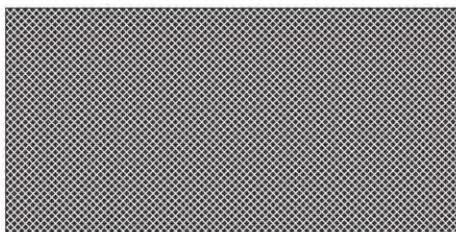

SMOOTH

The smooth insert is designed to hold the smaller suture sizes without damage to the suture or needle. Its needleholding ability is somewhat limited, however. Used primarily in needle holders for plastic surgery and microsurgery.



Micro

BC-04-101 11.5 cm
BC-04-102 12.5 cm

Par-style

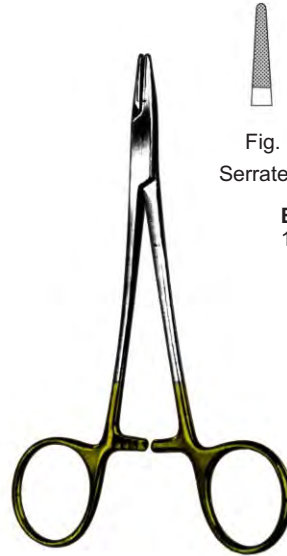

Fig. 1
Serrated

Fig. 2
Smooth

BC-04-103
1.2 cm

Webster



BC-04-104
1.3 cm
Serrated
Mini profile
perfil mini
perfil mini

Kilner

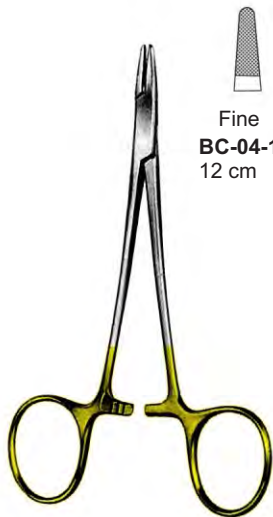

Fine
BC-04-105
12 cm

Derf

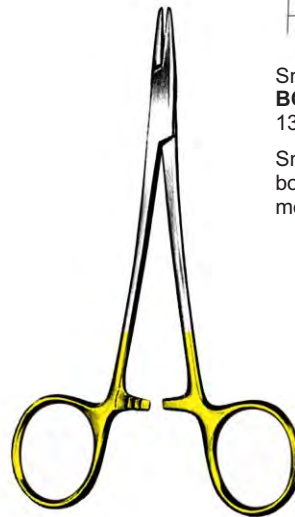

Smooth
BC-04-106
13 cm

Smooth jaw
boca lisa
mors lisse

Serrated
BC-04-107
13 cm

Mini profile
perfil mini
perfil mini

Halsey

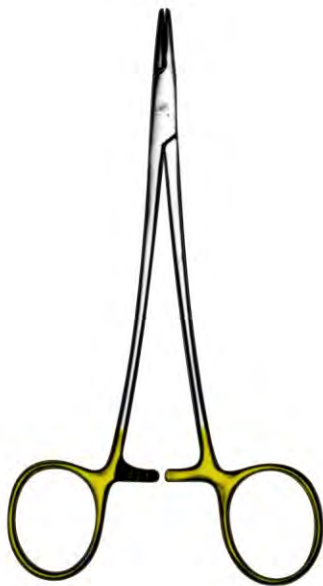

Fine
BC-04-108
 15 cm

Baby Crile-Wood

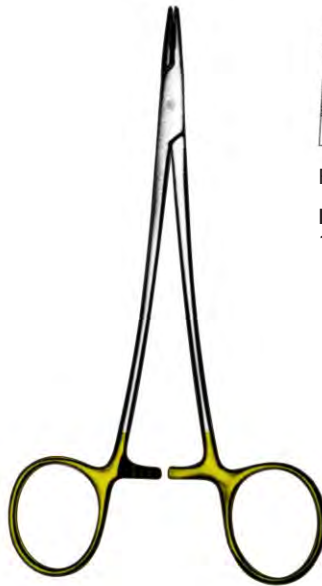

Fine
BC-04-109
 15 cm

Crile-Wood



Smooth
BC-04-110
 15 cm

Crile-Wood



Fine
BC-04-111 18 cm
BC-04-112 20 cm

Crile-Wood

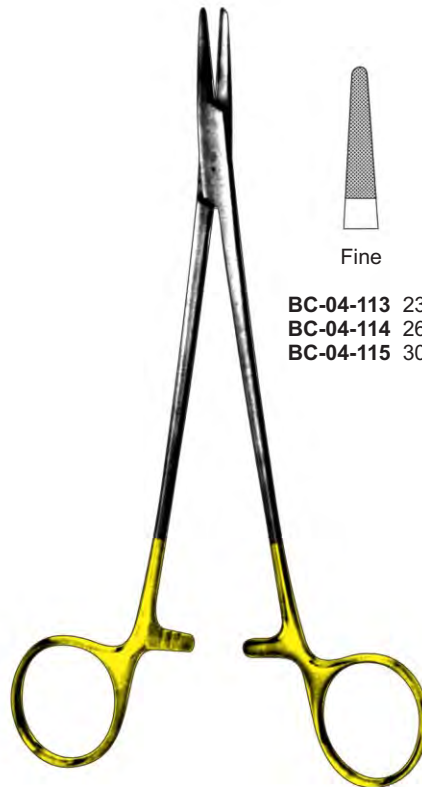

Fine
BC-04-113 23 cm
BC-04-114 26.5 cm
BC-04-115 30 cm

Crile-Wood

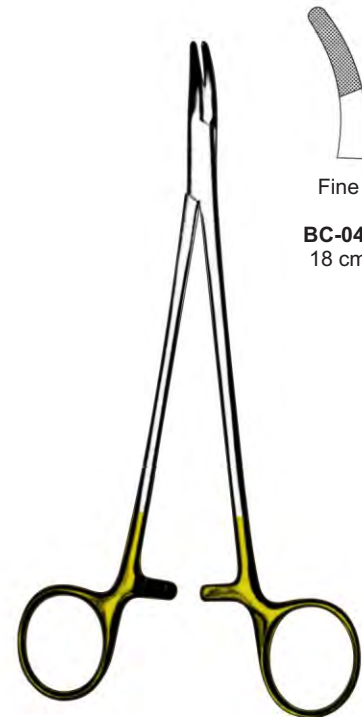

Fine
BC-04-116
 18 cm

Crile-Wood



Hegar- Baumgartner



BC-04-117
18 cm
mini profile
perfil mini
profil mini



BC-04-118
14.5 cm
mini profile
perfil mini
profil mini

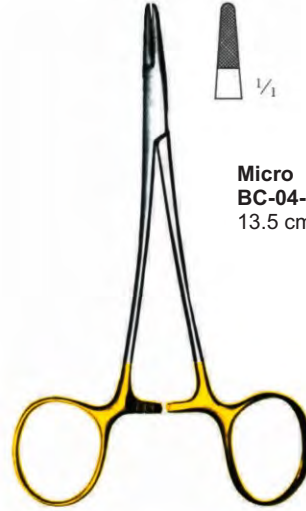

Offset ring



Micro
BC-04-119
13.5 cm

Neivert

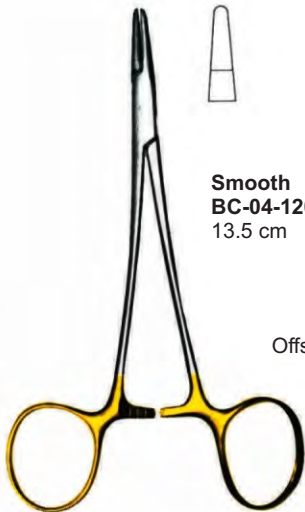

Offset ring



Smooth
BC-04-120
13.5 cm

Neivert



Crile-wood



BC-04-121
15 cm / 6
mini profile
perfil mini
profil mini



Offset ring



BC-04-122
15 cm

Crile-wood modif

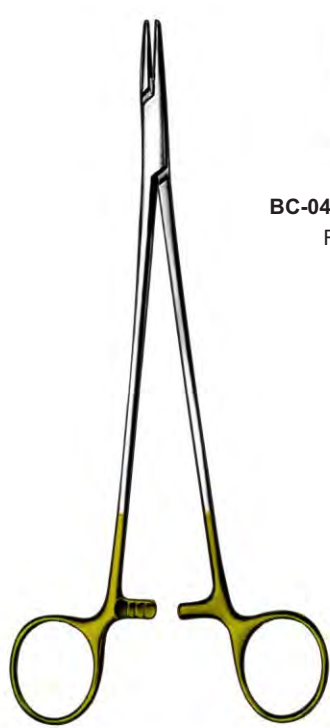

Crile-wood



BC-04-123 20-5 cm
 Regular

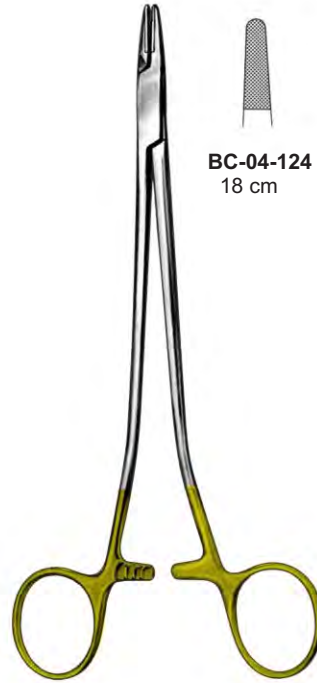

Sarot
 Crile-Wood



BC-04-124
 18 cm



BC-04-125
 20 cm



BC-04-126
 26 cm

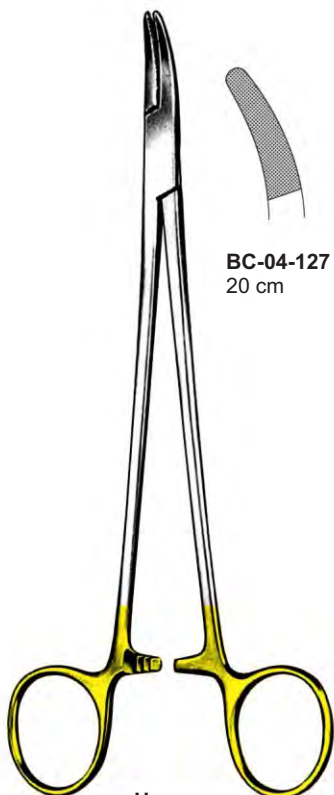

Heaney

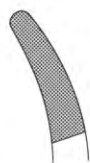

BC-04-127
 20 cm

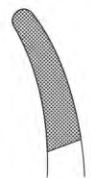

BC-04-128
 24 cm



BC-04-129
 26 cm



New Orleans



BC-04-130
 17.5 cm
 Regular



Martin

BC-04-131 15 cm



BC-04-132 17 cm



BC-04-133 20 cm

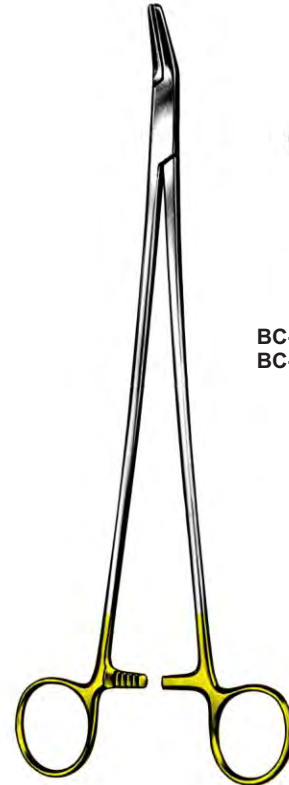

Finochietto

BC-04-134 21 cm
BC-04-135 26 cm



Regular



Pittmann



Regular

BC-04-136 18-5 cm



Regular

BC-04-137 20-5 cm



Regular

BC-04-138 24 cm

BC-04-139 26 cm

BC-04-140 30 cm

Upward Curved jaw configuration allows exceptional torque or driving force to be generated. Needle remains in upward position when needle holder shanks are at 45° angle.

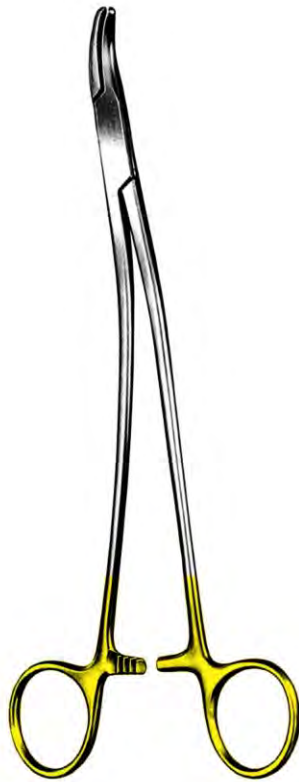

Stratte



BC-04-141
23 cm



BC-04-142
23 cm

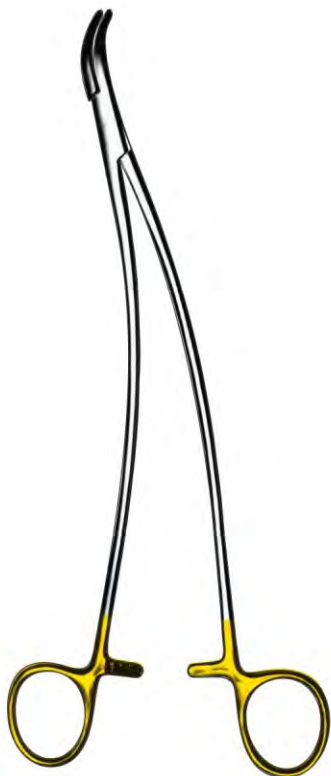

Stratte Delicate

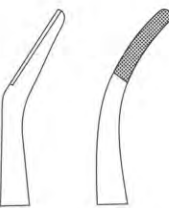
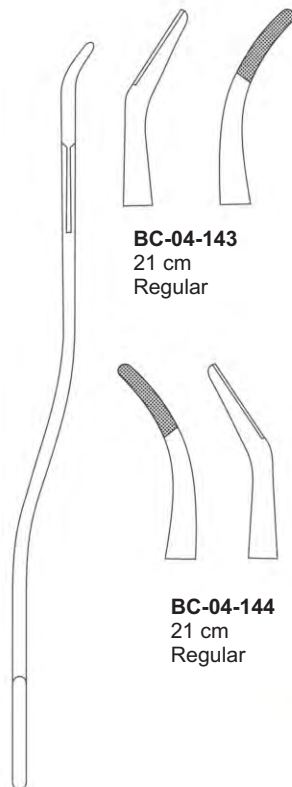

BC-04-143
21 cm
Regular

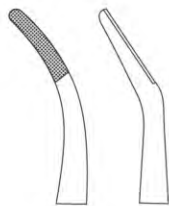

BC-04-144
21 cm
Regular

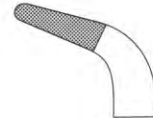
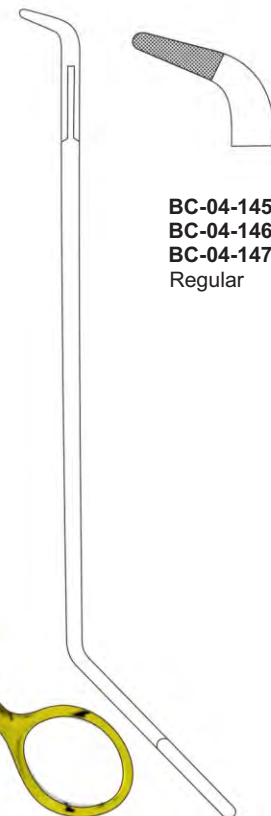
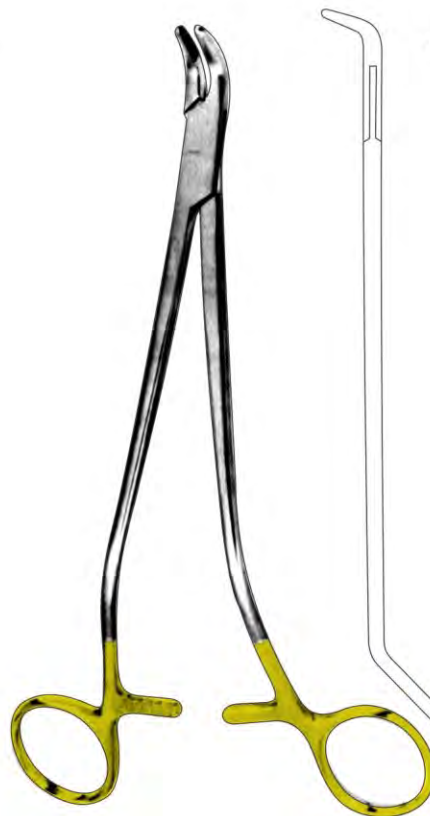

BC-04-145 20 cm
BC-04-146 25 cm
BC-04-147 28 cm
 Regular

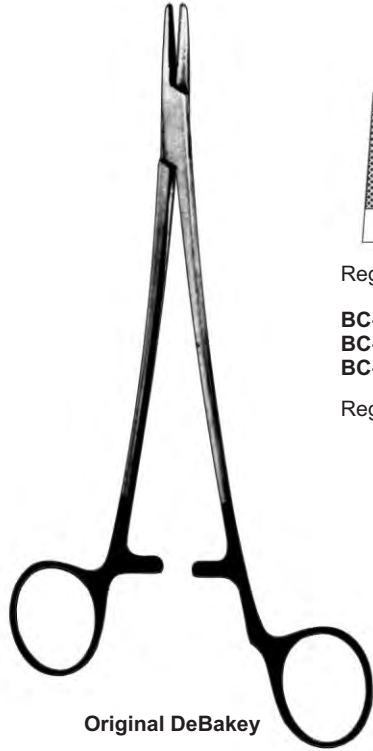

Regular

BC-04-148 19.5 cm

BC-04-149 21.5 cm

BC-04-150 24.5 cm

Regular pattern



Fine

BC-04-151 16.5 cm

Delicate pattern



Fine

BC-04-152 19.5 cm

BC-04-153 24.5 cm

Delicate pattern

With black oxidized ring handles
for identification as "Original DeBakey"

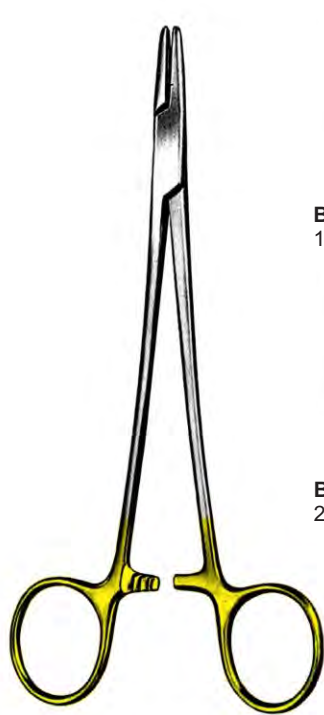

Mayo-Hegar



BC-04-154
16 cm

BC-04-155
18 cm

BC-04-156
20 cm



BC-04-157
24 cm

BC-04-158
26 cm

BC-04-159
30 cm

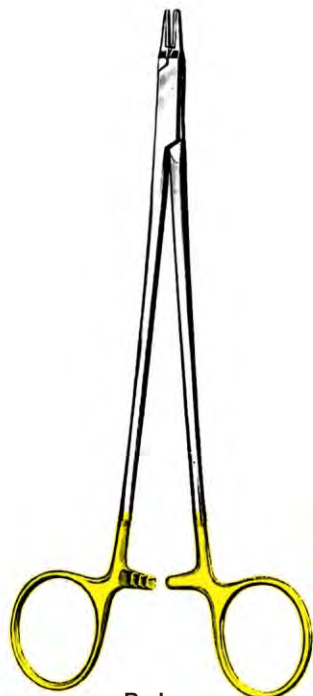

Ryder



BC-04-161
12-5 cm

BC-04-162
15 cm

BC-04-163
18 cm



BC-04-164
20 cm

BC-04-165
23 cm

BC-04-166
26 cm







Masson









BC-04-160
26-5 cm



- | | | |
|---|--|---|
|  |  |  |
| BC-04-167
18 cm | BC-04-168
20 cm | BC-04-169
23 cm |
|  |  | |
| BC-04-170
26 cm | BC-04-171
31 cm | |



- | | | |
|---|--|---|
|  |  |  |
| BC-04-172
12-5 cm | BC-04-173
15-5 cm | BC-04-174
17-5 cm |
|  |  |  |
| BC-04-175
20-5 cm | BC-04-176
22-5 cm | BC-04-177
26-5 cm |

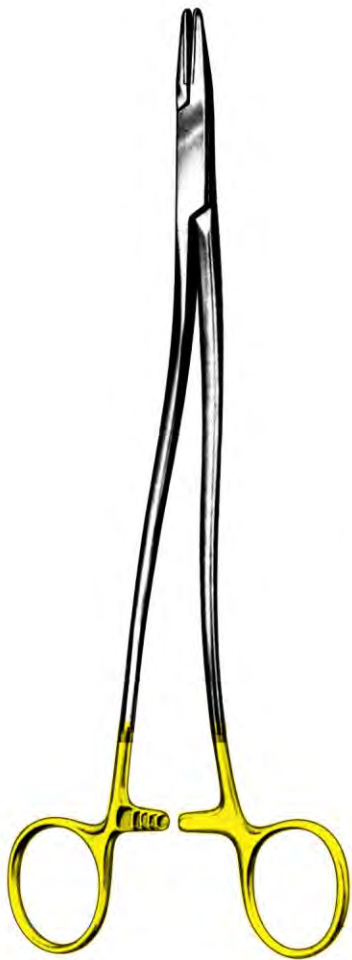

Bozemann



BC-04-178
20.5 cm



BC-04-179
24 cm



BC-04-180
26.5 cm



BC-04-181
29 cm

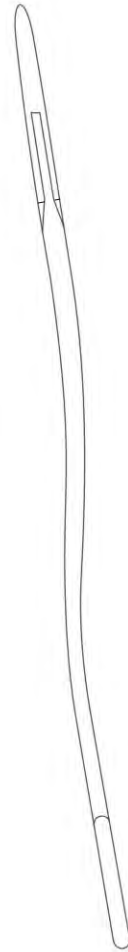

BC-04-182
27 cm



Wangensteen



BC-04-183
14 cm



BC-04-184
18.5 cm



BC-04-185
20.5 cm



BC-04-186
23 cm



Hegar-Vascular

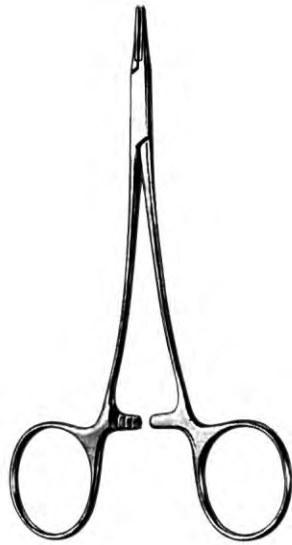

Martini



BC-04-187
14 cm



BC-04-188
16 cm



BC-04-189
17-5 cm



BC-04-190
20 cm



BC-04-191
14 cm



BC-04-192
16 cm



BC-04-193
17-5 cm



BC-04-194
20 cm



Micro-Vascular



BC-04-195
14 cm



BC-04-196
17-5 cm



BC-04-197
20 cm



BC-04-198
23 cm

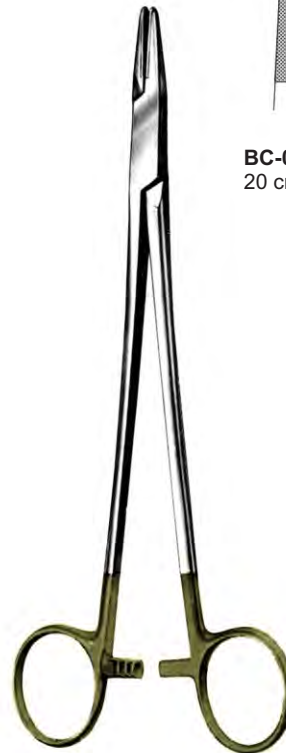

Hegar



BC-04-199
20 cm



BC-04-200
23-5 cm



Fine
BC-04-201 14.5 cm

Olsen-hegar



Fine
BC-04-202 17 cm



Regular
BC-04-203 18.5 cm

Olsen-hegar

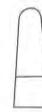
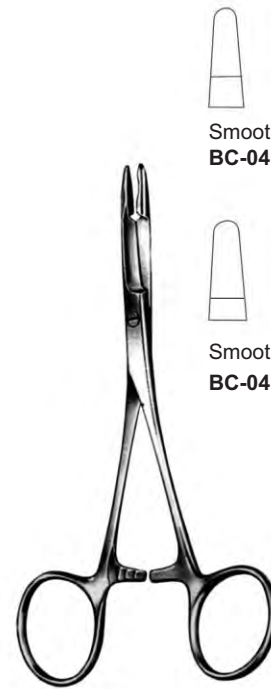

Smooth
BC-04-204 14.5 cm



Smooth
BC-04-205 17 cm

Olsen-hegar



BC-04-206 14.5 cm



BC-04-207 17 cm



BC-04-208 19 cm



Smooth
BC-04-209 10.5 cm

Foster-Gillies



Fine
BC-04-210 16 cm



Smooth
BC-04-211 16 cm

Gillies- Webster



Fine

BC-04-212 12 cm

Boynton



Fine

BC-04-213 16.5 cm

Arruga



Fine

BC-04-214 16.5 cm

Arruga



14 cm
BC-04-215
Regular

Mathieu



17.5 cm
BC-04-216



20 cm
BC-04-217

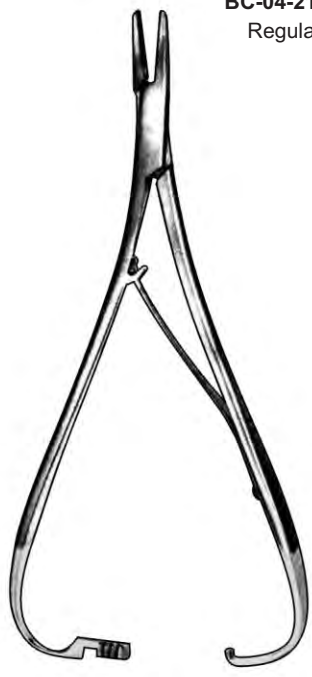

14 cm
BC-04-218
Regular

Mathieu-Kocher



17.5 cm
BC-04-219



20 cm
BC-04-220



17.5 cm
BC-04-221
Fine



20 cm
BC-04-222

Mathieu-Ryder



Fine
BC-04-223 18 cm

Toennis Delicate

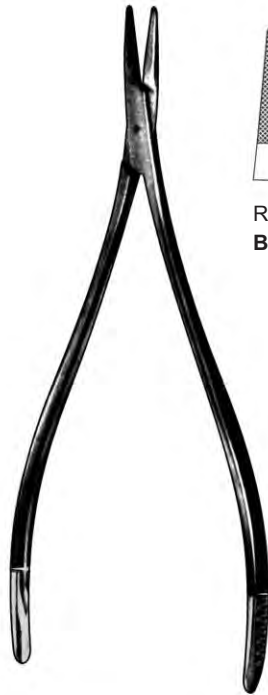

Regular
BC-04-224 18 cm

Toennis Delicate

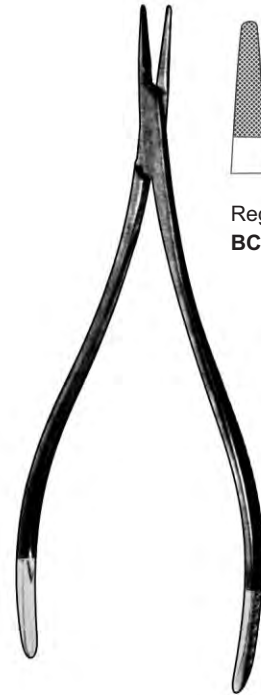

Regular
BC-04-225 18 cm

Toennis



Regular
BC-04-226 20 cm

Toennis

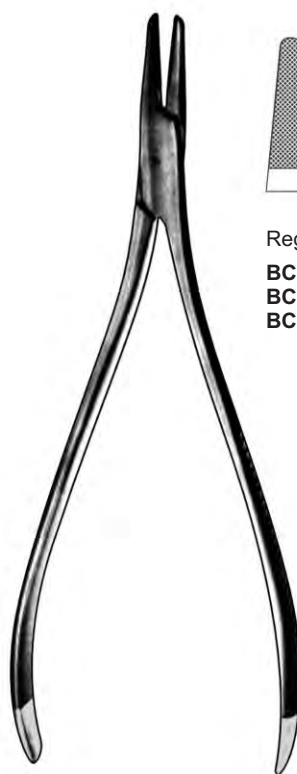

Regular
BC-04-227 16 cm
BC-04-228 18 cm
BC-04-229 20 cm

Langenbeck

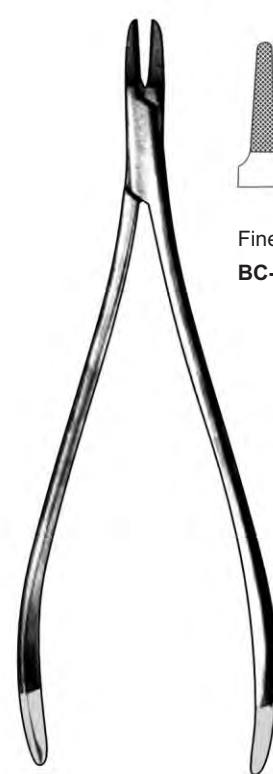

Fine
BC-04-230 20 cm

Langenbeck-Ryder

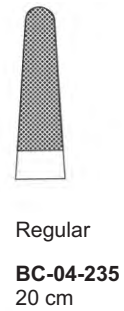
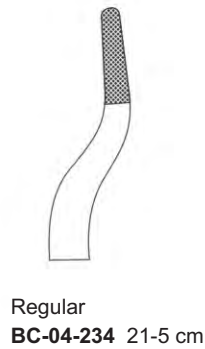
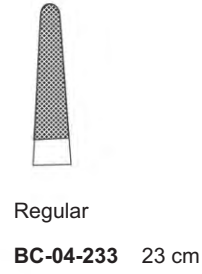
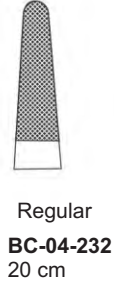



0.2
BC-04-236
 210 mm, 8¼"

HELLBERG / KUPKA



0.2
BC-04-237
 90 mm, 7½"

REIN / KUPKA



0.2
REIN / KUPKA
BC-04-238
 Needle holder with catch
 190 mm 7½"



0.4
MÜLLER
BC-04-239
 Ergonomic handle
 175 mm, 7"

These instruments provide the surgeon with a maximum of ergonomical comfort. The optimized design of the Instruments offers a fatigue-free working especially-with regard to difficult suture and anastomosis techniques.

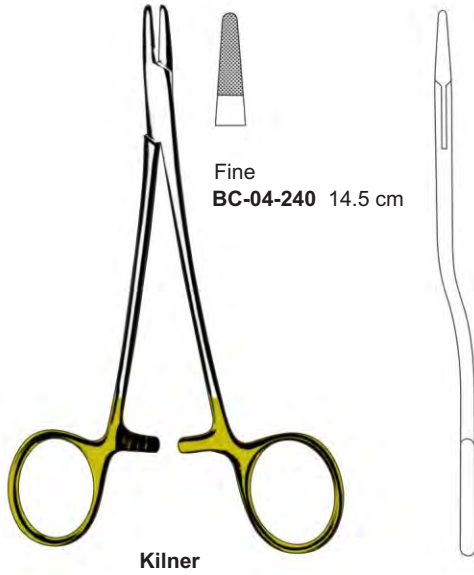

Fine
BC-04-240 14.5 cm

Kilner

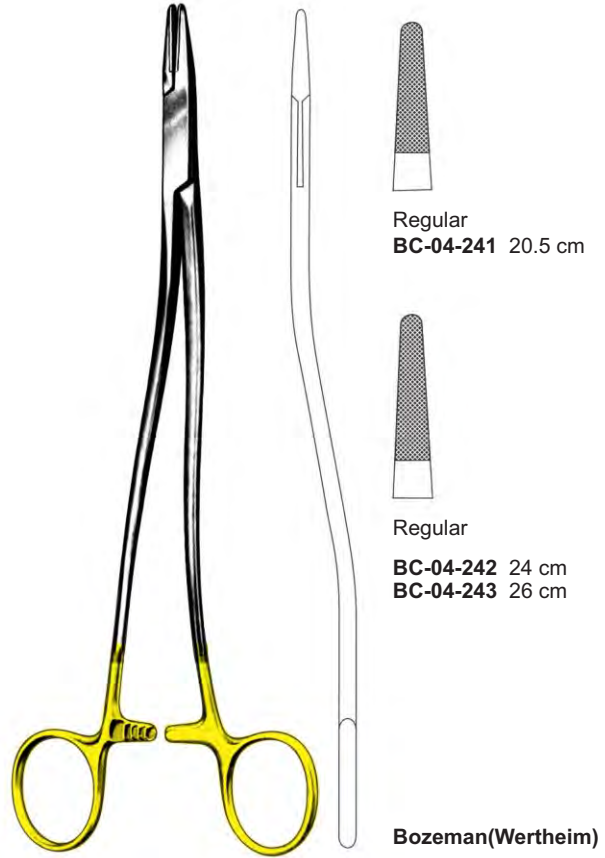

Regular
BC-04-241 20.5 cm

Regular
BC-04-242 24 cm
BC-04-243 26 cm

Bozeman(Wertheim)

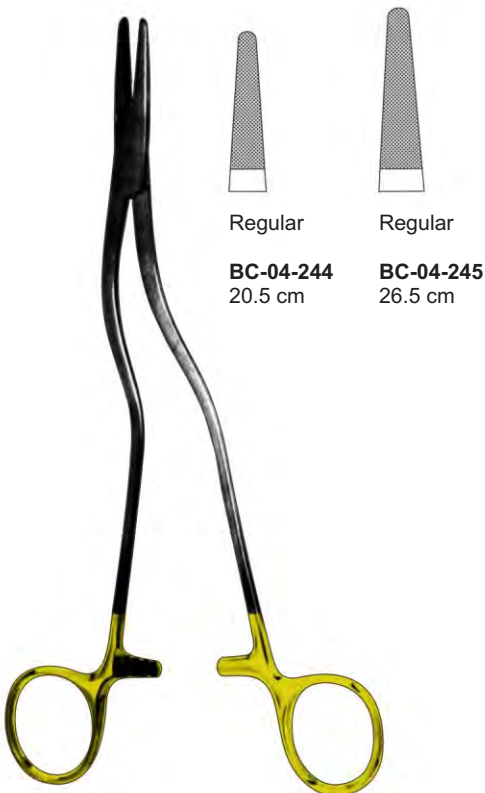

Regular
BC-04-244 20.5 cm

Regular
BC-04-245 26.5 cm

Masson-Luethy

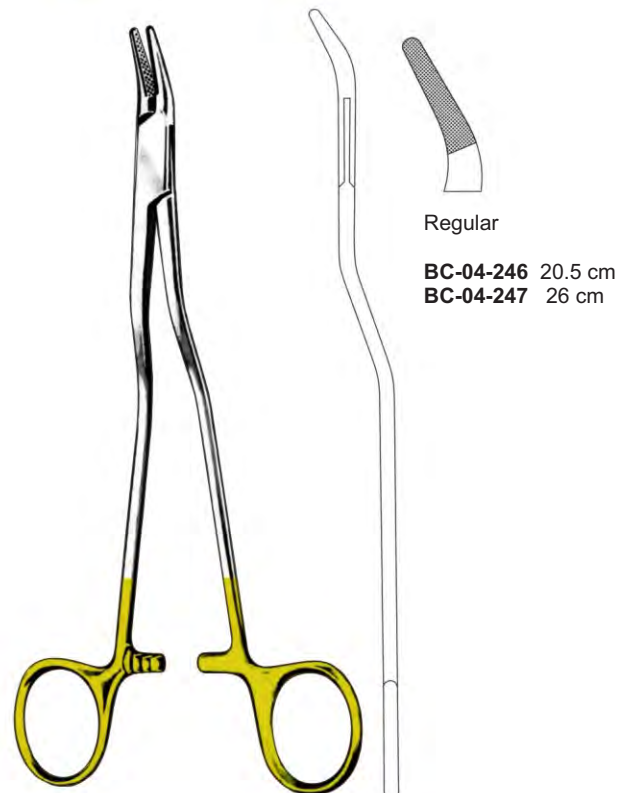

Regular
BC-04-246 20.5 cm
BC-04-247 26 cm

Bozeman-Finochietto

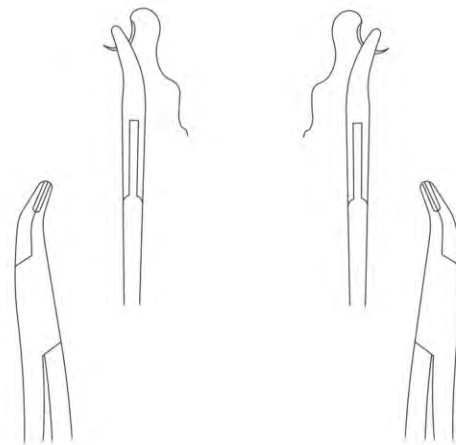

The corkscrew design of the jaws permits easier suturing when operating field is restricted or difficult of access.

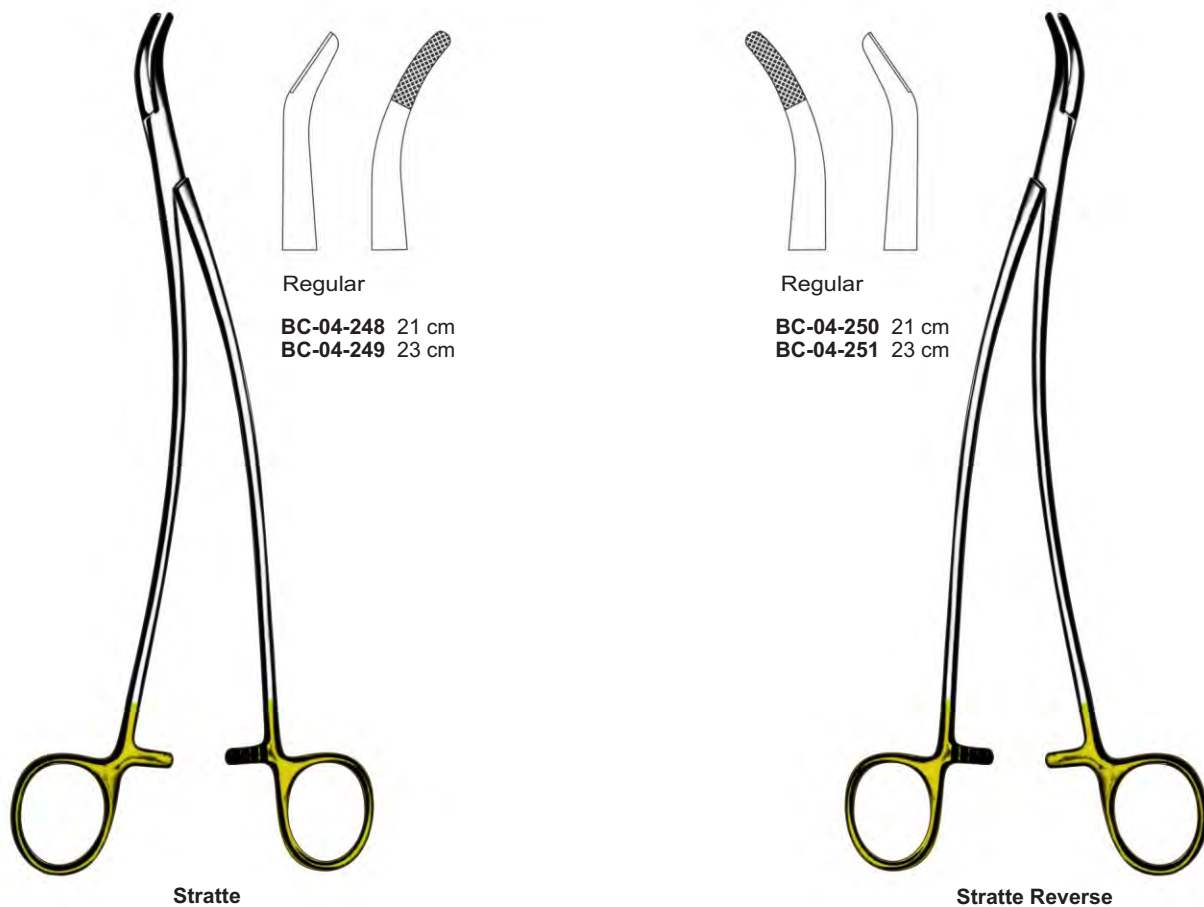

Regular
BC-04-248 21 cm
BC-04-249 23 cm

Regular
BC-04-250 21 cm
BC-04-251 23 cm

Stratte

Stratte Reverse

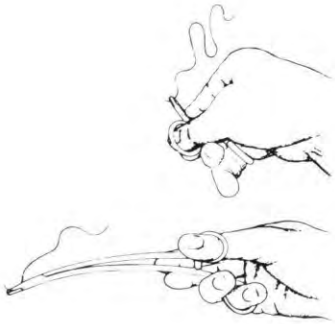

For right-handers
Left hand patterns available on request..

Instrument set



BC-04-252 24 cm

Turner-Warwick



Fine
BC-04-253 24 cm

Turner-Warwick



Fine
BC-04-254 24 cm

Turner-Warwick

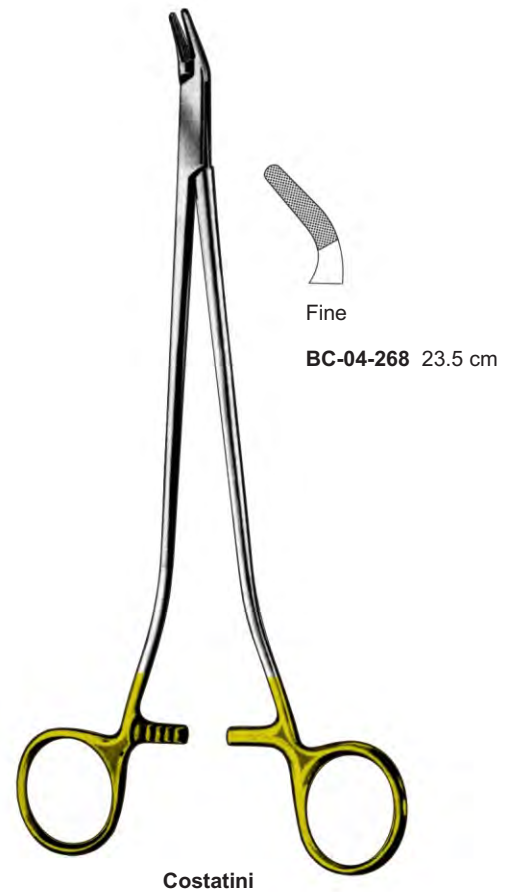
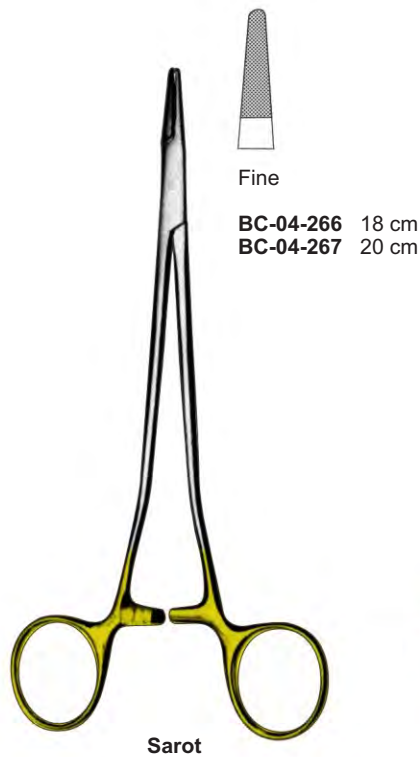
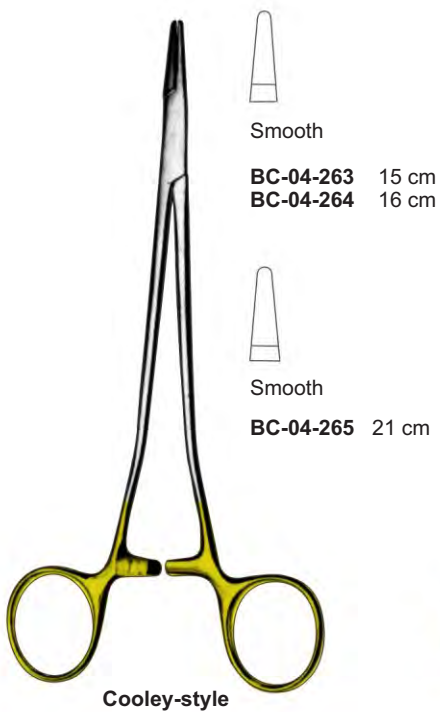
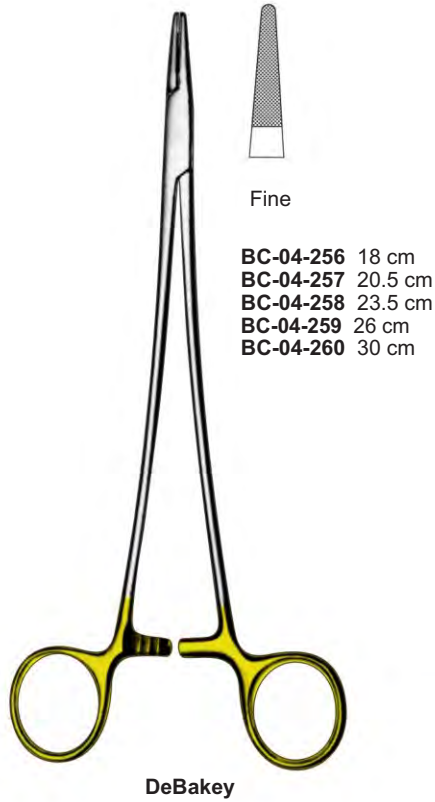
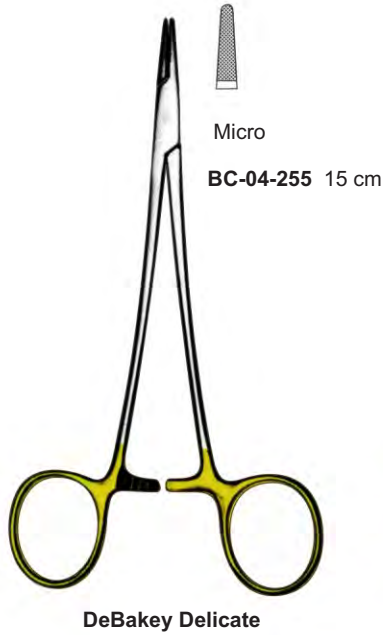

The LEMMON Needleholder was designed for vascular surgery. Tips tapered to the point.

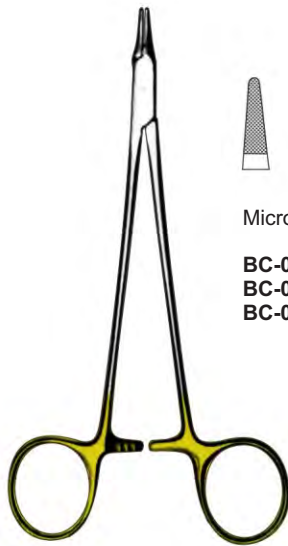

Micro

BC-04-269 14.5 cm
BC-04-270 17 cm
BC-04-271 19.5 cm

Lemmon

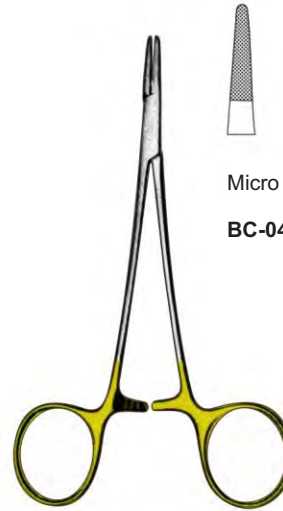

Micro

BC-04-272 14 cm

Microvascular



Fine

BC-04-273 18.5 cm



Micro

BC-04-274 18 cm
BC-04-275 20.5 cm
BC-04-276 23 cm

Microvascular



UNIVERSAL

A selected range of needle holders with unique ratchet design. Can be used by both, right-handed and left-handed surgeons.

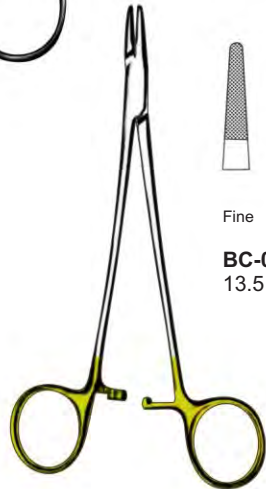

Fine

BC-04-277
13.5 cm

Universal Halsey

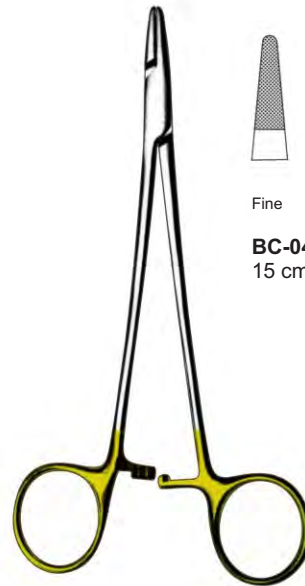

Fine

BC-04-278
15 cm

Fine

BC-04-279 18 cm
BC-04-280 20.5 cm

Universal Crile-Wood

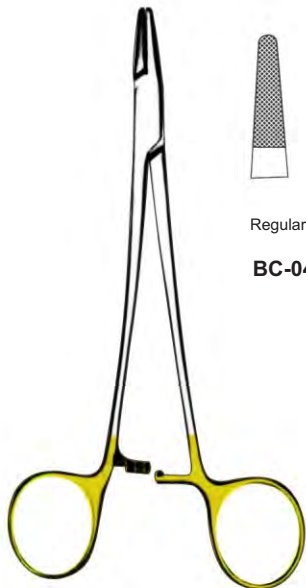

Regular

BC-04-281 16 cm



Regular

BC-04-282 19 cm
BC-04-283 20.5 cm

Universal Mayo-Hegar

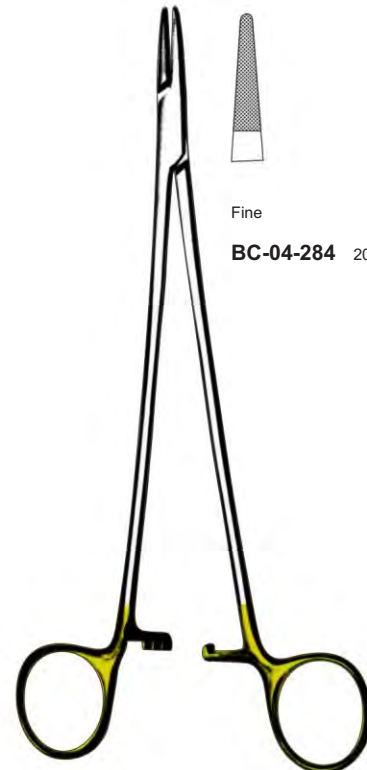

Fine

BC-04-284 20.5 cm

Universal DeBakey



Fine
BC-04-285 11.5 cm

Olsen-Hegar



Fine
BC-04-286 11.5 cm

Mobley-Webster



Smooth
BC-04-287 11.5 cm

Mobley-Webster



Smooth
BC-04-288 11.5 cm

Olson-Webster



Fine
BC-04-289 14.5 cm

Mobley-Webster



Smooth
BC-04-290 14.5 cm

Mobley-Webster



MINI-RYDER Needleholders with new special Micro Tungsten Carbide to hold needles and sutures up to 10 x 0. A well-balanced needleholder for delicate surgical procedures.

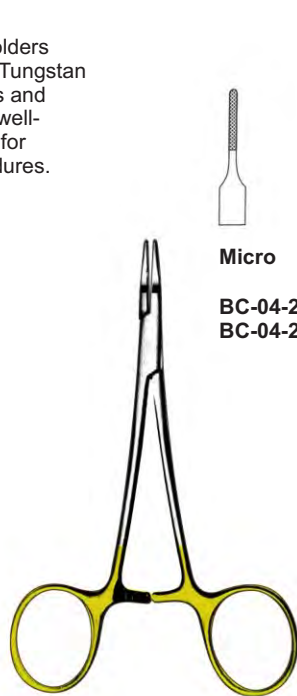

Micro

- BC-04-291 12 cm
- BC-04-292 15 cm

Mini-Ryder

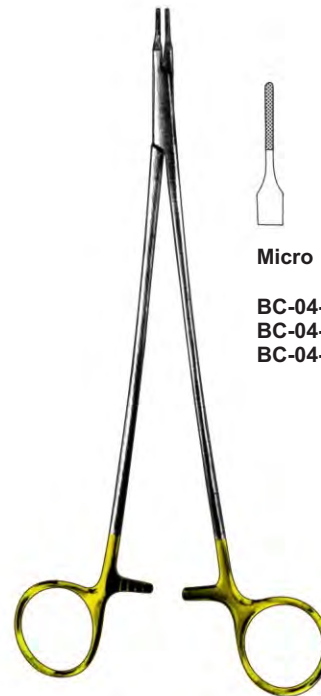

Micro

- BC-04-293 18 cm
- BC-04-294 20 cm
- BC-04-295 23 cm

Mini-Ryder



Micro

- BC-04-296 16 cm
- BC-04-297 18 cm
- BC-04-298 20 cm
- BC-04-299 23 cm

Diethrich

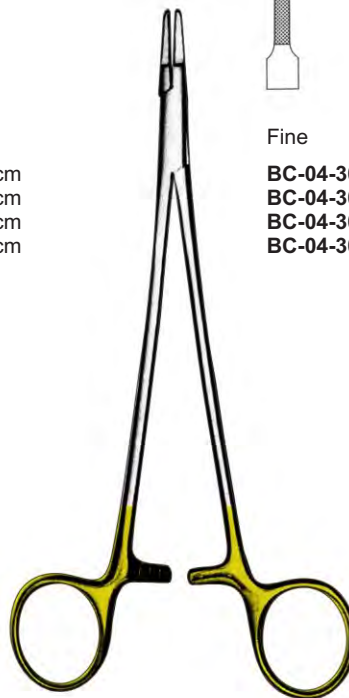

Fine

- BC-04-300 18 cm
- BC-04-301 20.5 cm
- BC-04-302 23 cm
- BC-04-303 26.5 cm

Intracardiac

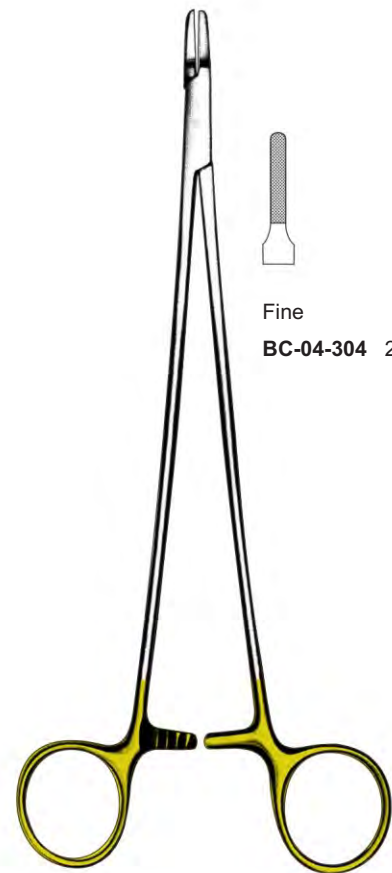

Fine

- BC-04-304 22.5 cm

Hufnagel-Ryder



Fine

BC-04-305 13 cm
BC-04-306 15 cm

French Eye Delicate

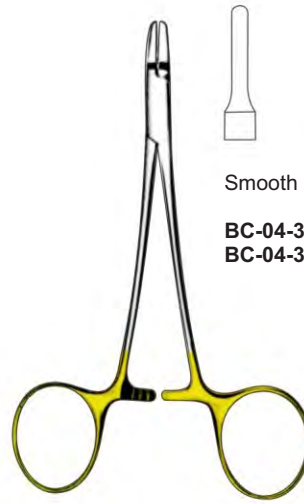

Smooth

BC-04-307 13 cm
BC-04-308 15 cm

French Eye Delicate

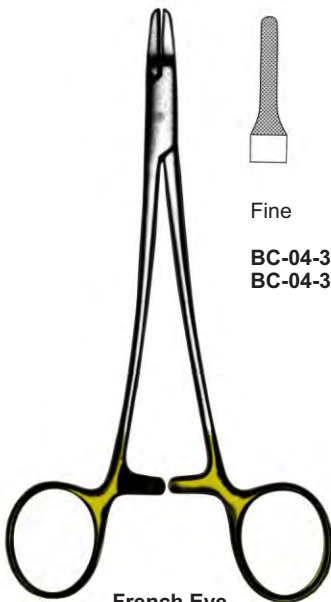

Fine

BC-04-309 16 cm
BC-04-310 18 cm

French Eye



Fine

BC-04-311 20.5 cm
BC-04-312 23.5 cm
BC-04-313 26 cm

French Eye



EUFRATE PASQUE Needle-
 holders to hold needles and
 sutures up to 10 x 0.
 Specially designed for intra-
 cardiac and delicate urological
 surgery in neonates..

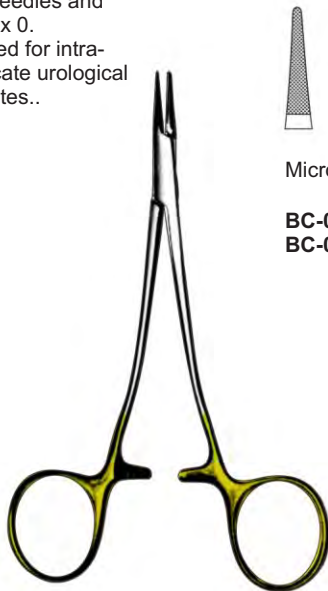

Micro

BC-04-314 14 cm
BC-04-315 15 cm

Eufrate-Pasqué

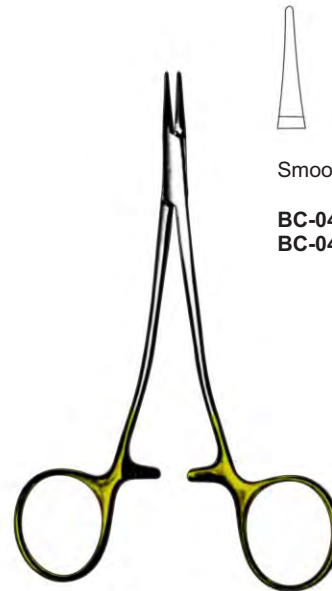

Smooth

BC-04-316 14 cm
BC-04-317 15 cm

Eufrate-Pasqué



Micro

BC-04-318 18 cm
BC-04-319 20 cm

Eufrate-Pasqué



Smooth

BC-04-320 18 cm
BC-04-321 20 cm

Eufrate-Pasqué



Micro



14 cm
WI-04-322



WI-04-323 14 cm
WI-04-324 18 cm

Castroviejo



Micro



14 cm
WI-04-325



14 cm
WI-04-326

Castroviejo



Micro



WI-04-327 18 cm
WI-04-328 22 cm



WI-04-329 22 cm

Castroviejo



14 cm
WI-04-330



14 cm
WI-04-331

Smooth

Castroviejo



Smooth

WI-04-332 18 cm
WI-04-333 22 cm

Castroviejo



Regular

WI-04-334 18.5 cm

Leibinger-castroviejo

Needle Holders with tungsten carbide edges
 Porta-agujas con filos de carbure tungsteno
 Porta-aiguilles avec des lames en tungstene



Micro Needle Holders



Smooth
BC-04-335
 13.5 cm

Castroviejo



Fine
BC-04-336
 14 cm

Kalt



Fine
BC-04-337
 16 cm

Tessier



Regular
BC-04-338 18.5 cm
BC-04-339 22 cm

Double-Action

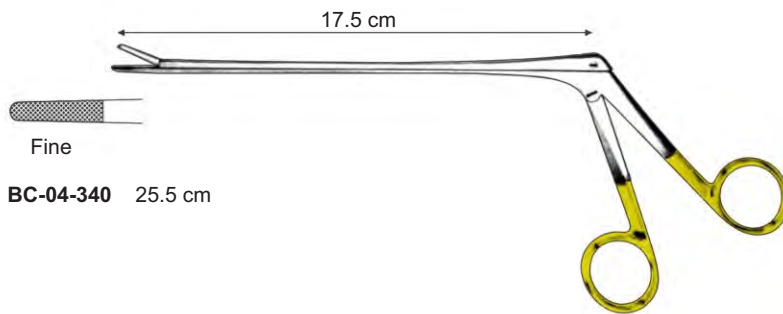

Fine
BC-04-340 25.5 cm

Schacke



Fine
BC-04-341 22 cm

Leibinger-Marberger

An IUD in place but no visible thread...?
 Here is your help:
 The shaft of the IUD removal forceps has the same diameter as the cervical canal. It can be used without dilation and without anaesthesia. Its jaws with finely serrated TC-inserts get a firm grip of the IUD (. . . Or its thread) for safe and simple removal.



BC-04-342
15 cm / 6"



BC-04-343
15 cm / 6"

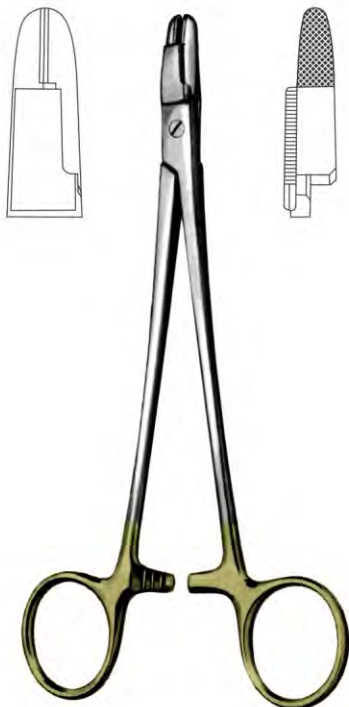

BC-04-344
18 cm / 7"



BC-04-345
18.5 cm / 7 1/4"



LINDORF
BC-04-346
20 cm / 8"



These powerful broad jaw patterns have Tungsten Carbide inserts which hold the wire securely under the strain of the entire wire twisting process. They serve as sternal needle holders as well thus providing heavy sternal needles.



Coarse
BC-04-347 18.5 cm

Berry



Coarse
BC-04-348 17.5 cm

Mathieu-Style

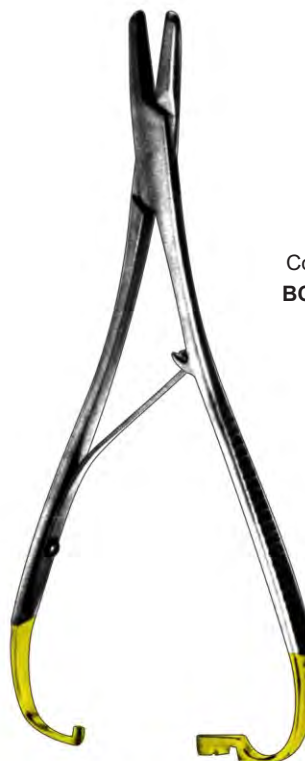

Coarse
BC-04-349 20 cm

Mathieu-Style



Regular
BC-04-350 13 cm



Leibinger



Regular
BC-04-351 15 cm



Regular
BC-04-352 18 cm



Regular
BC-04-353 15 cm
BC-04-354 18 cm



Hegar



Regular
BC-04-355 17.5 cm



Kremer



Regular
BC-04-356 15.5 cm



Korkhaus
Wire Ligature Forceps

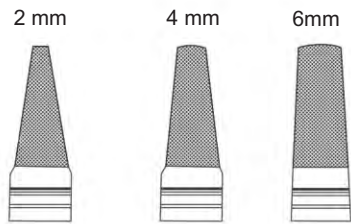

BC-04-357-1 18 cm / 7"
BC-04-357-2 18 cm / 7"
BC-04-357-3 18 cm / 7"



BC-04-2005 17 cm / 6¾"
BC-04-2006 20 cm / 8"

Mathieu-Hauberisier

Wirt Holding Forceps
 Pinzas para extraer alambres
 Pincas tire-broches

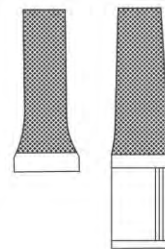
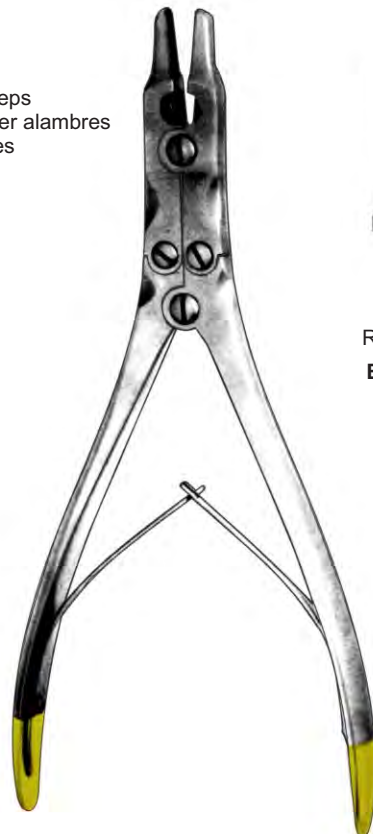

Regular
BC-04-358 22 cm / 8"

Leibinger

Lower jaw



Pin Puller

Upper jaw



Coarse
BC-04-359 13.5 cm



Coarse
BC-04-360 14.5 cm



Flat Nose Plier



Coarse
BC-04-361 13.5 cm



Flat Nose Plier

Double-action Wire Pulling and Bending Pliers with Tungsten Carbide inserts. A reliable instrument for wire-bending and extraction of K-wires, pins etc. Ensures secure grasping and holding, reduces hand-fatigue.

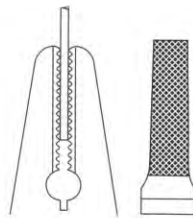

Coarse
BC-04-362 18 cm

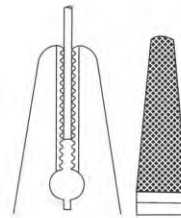

Coarse
BC-04-363 18 cm

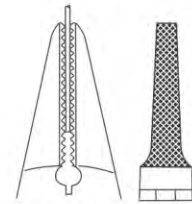

Coarse
BC-04-364 18 cm

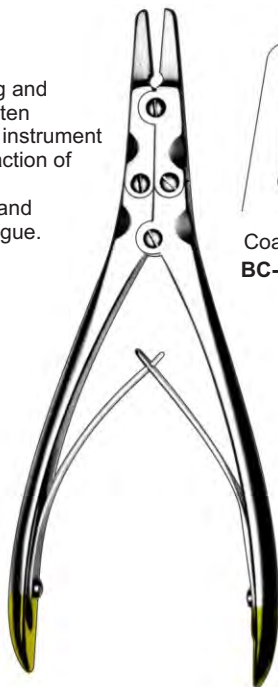

Pechlaner

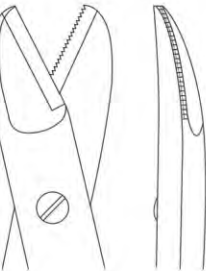

BC-04-365 12 cm

Ligature wire 0.8 mm diam

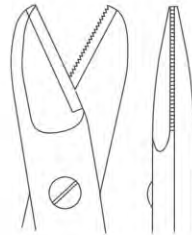

BC-04-366 16 cm

Smith
 Ligature wire 1.0 mm diam

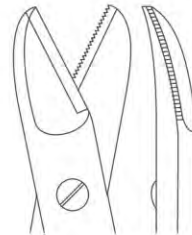

BC-04-367 16 cm

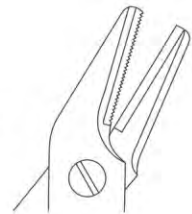
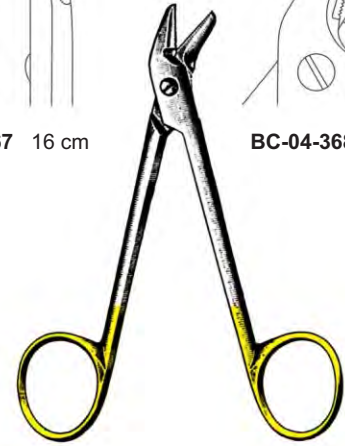

BC-04-368 12 cm

Universal
 soft wire 1.0 mm diam
 hard wire 0.6 mm diam

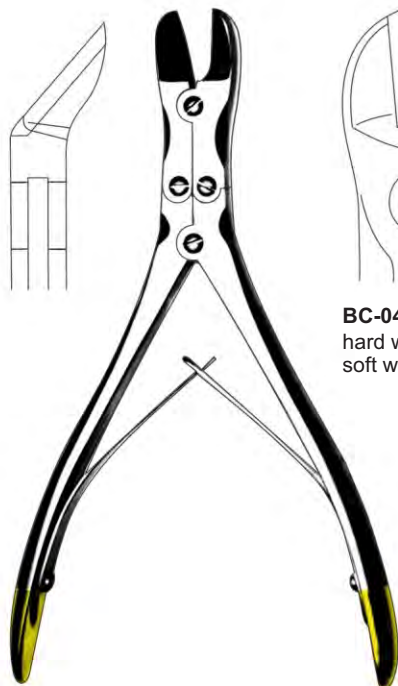

BC-04-369 18 cm
 hard wire 1.0 mm dia.
 soft wire 1.6 mm dia.

These double-action power wire cutters are extremely versatile. They possess excellent cutting ability through their Tungsten Carbide cutting edges. Cut easily on the full length of the jaws.

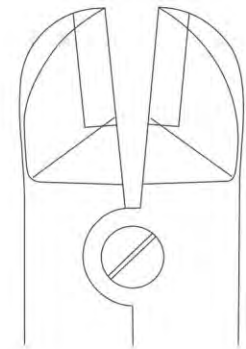
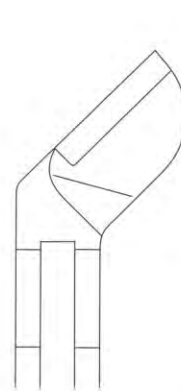

BC-04-370 23.5 cm

soft wire 2.7 mm dia.
 hard wire 2.0 mm dia.



For hard wire
0.6 mm diam
For soft wire
1.0 mm diam

BC-04-371
12.5 cm / 5"

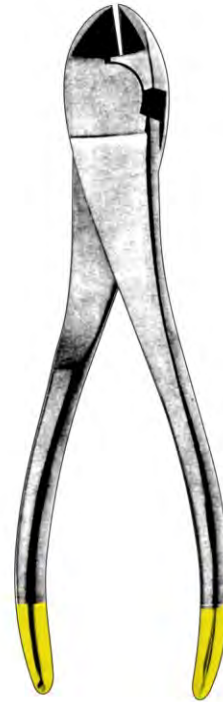

For soft wire
2.0 mm diam
For hard wire
1.7 mm diam

BC-04-372
18.5 cm / 7 1/4"



1.6 mm For
hard wire
2.6 mm For
soft wire

BC-04.373
17.5 cm / 7"

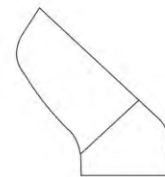
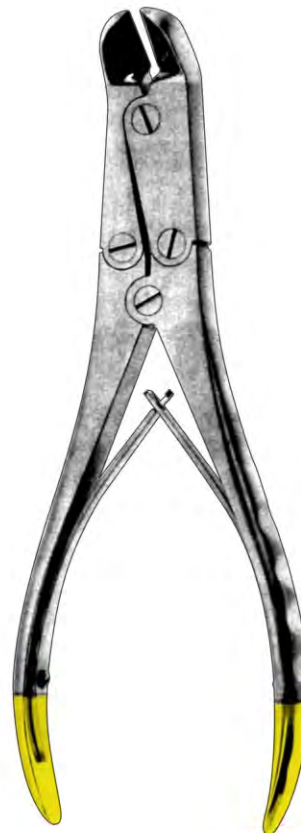

For soft wire
2.8 mm diam
For hard wire
2.2 mm diam

BC-04.374
22 cm / 8 3/4"

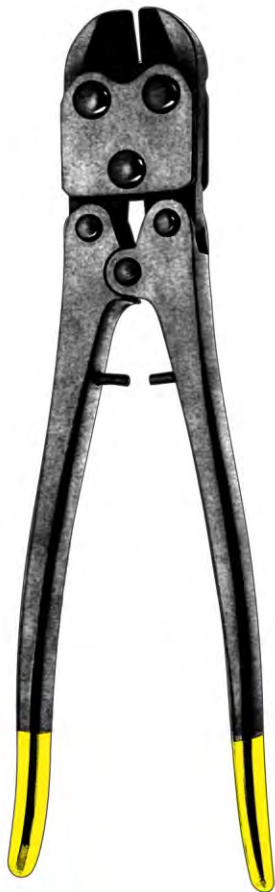

BC-04-376
23.5 cm / 9¼"
Wire Cutter whit
Tungsten carbide Edges



Soft Wire 3 mm
Hard Wire 2.7 mm



BC-04-377 48 cm /18¼"
BC-04-378 54 cm /21¼"
Cutters for cutting of wires, screws and
pins up to diam. 6 mm

Alicates corta-alambres, tornillos y
clavos hasta Ø 6 mm

Pinces á couper les fils, pivots et clous
jusqu, á 6 mm Ø

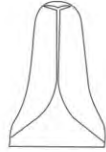
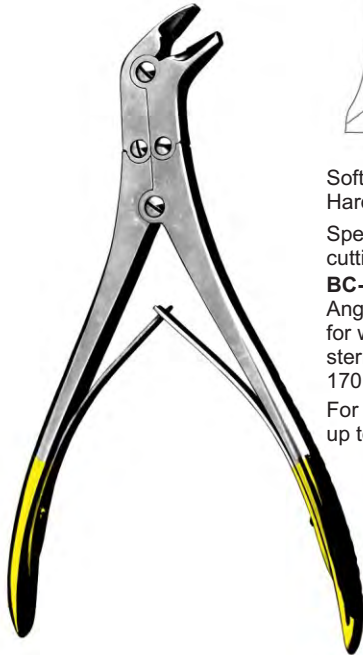

Soft Wire 0,9 mm
Hard Wire 0,9 mm
Specially hardened cutting edges
BC-04-379
Angled slender pattern for wire removal after sternum suture.
170 mm / 6 $\frac{3}{4}$ "
For hard wire up to diam

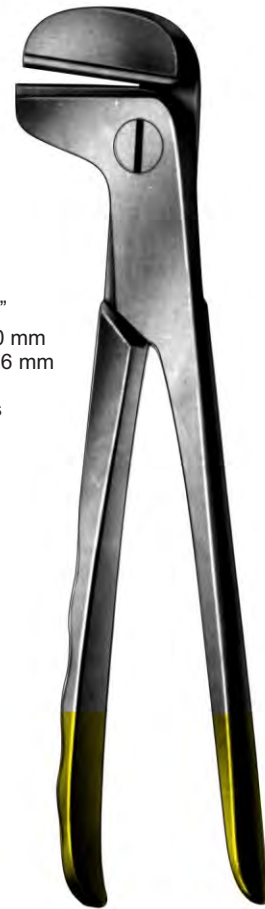

BC-04-380
240 mm / 9 $\frac{1}{2}$ "
Soft Wire 2,0 mm
Hard Wire 1,6 mm with carbide cutting edges

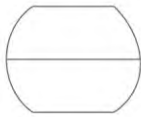

Specially hardened cutting edges

BC-04-381 145 mm / 5 $\frac{3}{4}$ "
Soft Wire 1,5 mm
Hard Wire 1,0 mm



Specially hardened cutting edges

BC-04-382 220 mm / 8 $\frac{3}{4}$ "
Soft Wire 3,5 mm
Hard Wire 2,5 mm
BC-04-383 145 mm / 5 $\frac{3}{4}$ "
Soft Wire 2,0 mm
Hard Wire 1,5 mm



BC-04-384
320 mm / 12 $\frac{3}{4}$ "
Hard Wire 3,0 mm
Cutter for cutting off KIRSCHNER wires, Tibia head screws, bolts, pins, up to 3 mm diam.