



Serving Humanity Since 1908

WELMED
INSTRUMENTS CO.

**TC-Gold Catalogue
Group 2, 3 & 4**



Manufacturers & Exporters of Quality Surgical Instruments

Tungsten Carbide Instruments



TC Scissors 02

WELMED Instruments Company
Defence Road
Near Wapda Grid Colony
Sialkot 51310, Pakistan.

Phone : +92 52 3554782, 3558704
Fax : +92 52 3550296
Cell : +92 333 8680640

Email : info@welmedinst.com
welmedpk@gmail.com
wmm@brain.net.pk
welmed@cyber.net.pk

Website : www.welmedinst.com

About Us

Quality begins at **WELMED** Instruments Company where master craftsmen forge and manufacture each instrument to its exact specifications and measurements. Instruments must undergo a series of quality control inspections in order to be worthy of **WELMED** name and warranty. We offer a wide selection of medical instruments including Surgical and Dental instruments.

We have acquired a unique and unmatched understanding of manufacturing through a large experience, working since 1908. Years of experience & state of the art manufacturing facilities helped us to keep our prices low. Our Surgical & Dental instruments are created by expert craftsmen, providing unfaltering quality you can rely on.

We have launched a fully interactive website where you can get online and track your orders 24 hours a day, 7 days in a week, and 365 days a year. Ask for our free e-catalogue on CD-Rom to save time and enjoy hassle free ordering.

We provide our customers with most reliable customer service as your satisfaction is our top priority. Our customers always enjoy our wonderful customer service and quality tools at the best price.

Lastly we invite you to have a work experience with **WELMED** Instruments Company and we will prove ourselves as one of the most valuable source you have.

You can find us at

WELMED Instruments Company
Defence Road, Near Wapda Grid Colony
Sialkot 51310, Pakistan.

Phone : +92 52 3554782, 3558704
Fax : +92 52 3550296
Cell : +92 333 8680640

Emails :
Info@welmedinst.com
welmedpk@gmail.com
wmm@brain.net.pk
welmed@cyber.net.pk

Website : www.welmedinst.com



History

WELMED Instruments Company was founded in 1995. Our Great Grandfather **Mian Muhammad Fazal Elahi** was the founder of M/s M.F. Elahi & Company (E.P.) Pvt. Ltd, established in 1908. WELMED is a sister concern of M.F. Elahi & Co. It is our pride to be a member of M.F. Elahi Family.

WELMED Instruments Company is located in the heart of beautiful city, Sialkot, Pakistan. We are manufacturers and exporters of quality Surgical, Dental instruments and Scissors of all sorts in various categories. We are closely attached with highly skilled surgeons and other technicians of the surgical industry to make the new instruments development possible.

WELMED is in a continuous process of development and testing of new instruments for their precision and perfect functioning. We are also working at imported forging supply by foreign customers.

Certificates

WELMED Instruments Company has achieved the certificates for ISO-9001, ISO-13485, cGMP (FDA) and CE Marking.

Quality Control

All material used in the manufacturing of our instruments are tested from relevant laboratories. Our continuous quality control is our best warranty so that you built confidence in our products.

Deliveries

Deliveries are quick and in-time.

Mode Of Payment

Terms of Payment is ADVANCE or LETTER OF CREDIT (Irrevocable)

Quality Policy

WELMED Instruments Company aims to produce quality Surgical, Dental instruments and Scissors of all sorts at reasonable prices to become an exemplary manufacturer. Our total emphasize is to achieve customer's satisfaction by clearly understanding their requirements and following a quality management system which is a primary concern of all our work force. We do our best to produce instruments of finest quality.



Warranty

All WELMED Instruments are produced from finest stainless steel available to be free from any defect in material or workmanship. Any product that proves to be defective in material or workmanship will either be repaired or replaced without any charge. This warranty is void if the instrument is abused, altered, modified or is not used in the manner for which it is intended.

TC Scissors

02

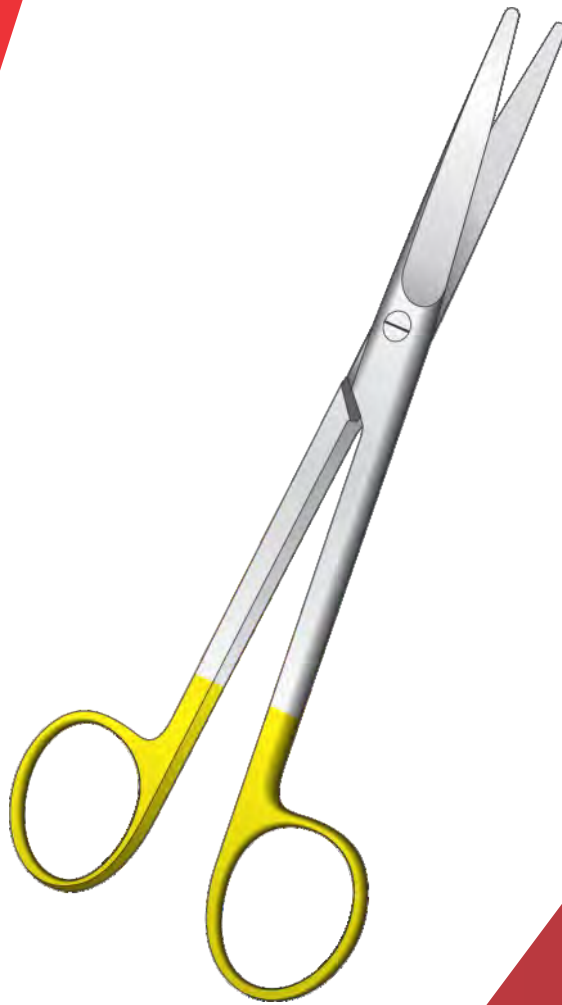

WELMED
INSTRUMENTS CO.

Caplan	15
Cottle	14
De Bakey	12
Dean	11
Disecting Scissors	1,3,9
Fomon	14
Goldmann-Fox	11
Gorney	15
Gum Scissors	11
Gynecology Scissors	16
Hegemann-Dietrich	13
Heymann	14
Iris Scissors Angular	01
Iris Scissors	01
Joseph	01
Kelly	01
Knight	14
Lexer	04
Locklin	11
Mayo	03
Mayo-Lexer	05
Mayo-Stille	05
Metzenbaum	04
Metzenbaum	06
Metzenbaum	07
Metzenbaum	08
Metzenbaum	10
Metzenbaum-Thorek	10
Nelson-Metzenbaum	09
Operating Scissors	02
Potts-Smith	13
Ragnell	04
Sims	16
Surgical Scissors	02
Toennis-Adson	04
Vascular Scissors	12,13



BC-02-101
 11.5 cm

Iris Scissors
 Iris Scissors
 Tijeras para iridectomía
 Ciseaux á iridectomie

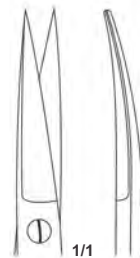

BC-02-102
 11.5 cm

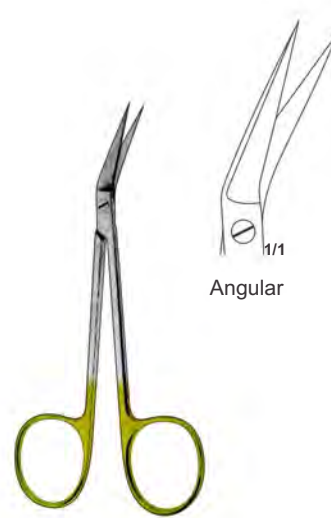

Angular

Iris Scissors
BC-02-103
 11 cm
 Iris Scissors
 Tijeras para iridectomía
 Ciseaux á iridectomie

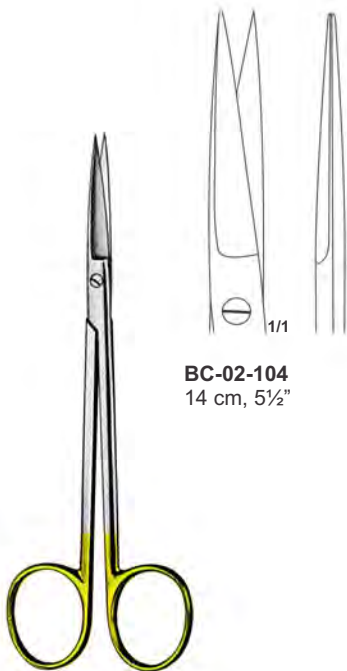

BC-02-104
 14 cm, 5½"

Joseph
 Plastic surgery scissors
 Tijeras para la cirugía plástica
 Ciseaux pour la chirurgie plastique

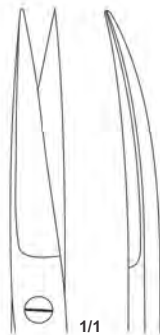

BC-02-105
 14 cm, 5½"

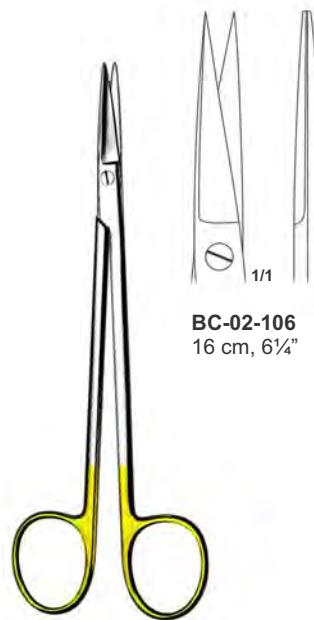

BC-02-106
 16 cm, 6¼"

Kelly
 Vascular and fistula scissors
 Tijeras para vasos y fístulas
 Ciseaux vasculaires et pour fistules

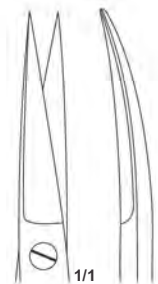

BC-02-107
 16 cm, 6¼"

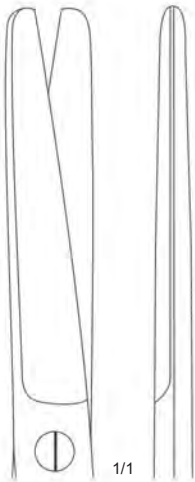

BC-02-108
14.5 cm, 5¾"

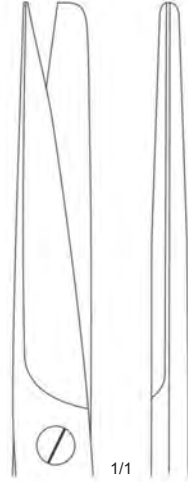

BC-02-110
14.5 cm, 5¾"

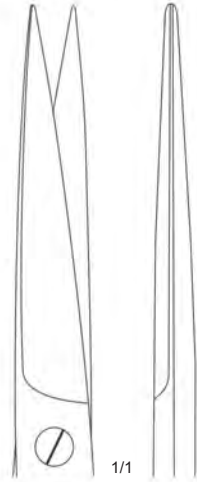

BC-02-112
14.5 cm, 5¾"

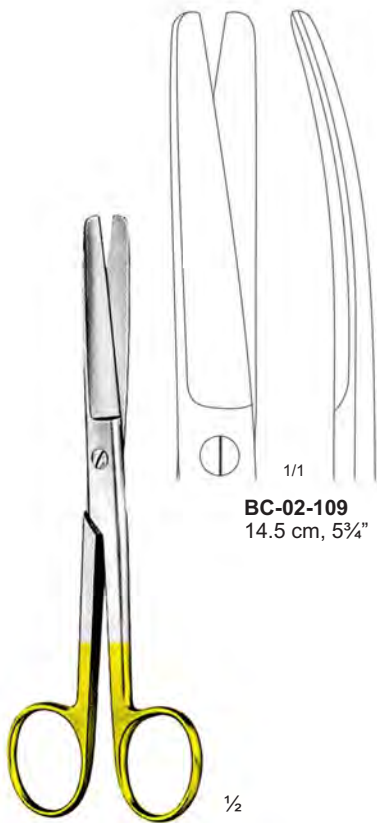

BC-02-109
14.5 cm, 5¾"

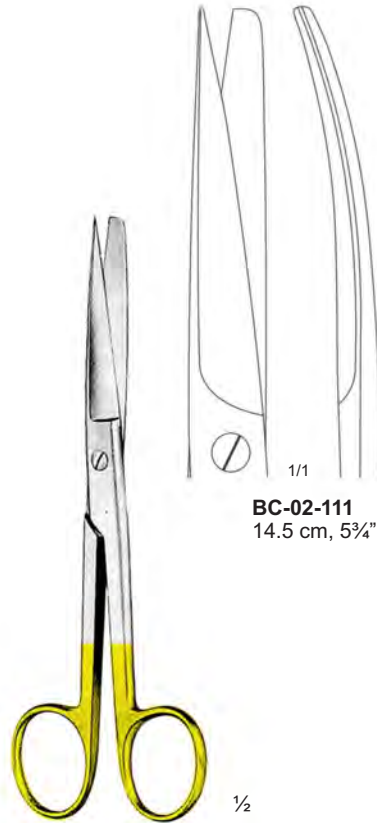

BC-02-111
14.5 cm, 5¾"

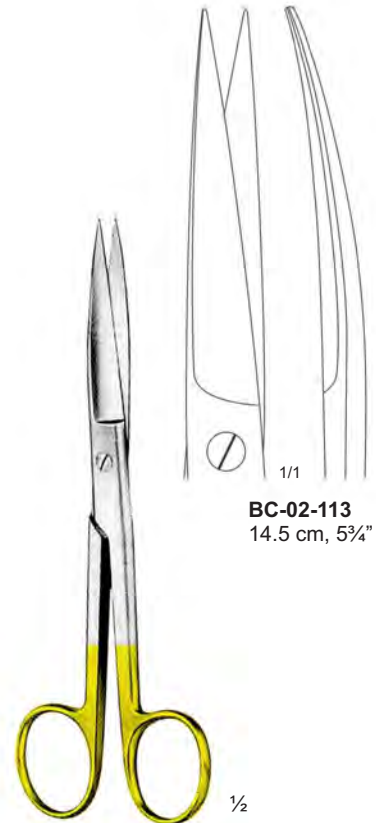

BC-02-113
14.5 cm, 5¾"

Blunt / Blunt
Standrad patterns
modelos standrad
modèles standrad

Sharp / Blunt
Standrad patterns
modelos standrad
modèles standrad

Sharp / Sharp
Standrad patterns
modelos standrad
modèles standrad

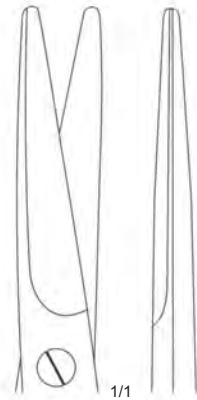

BC-02-114
 14.5 cm, 5¾"

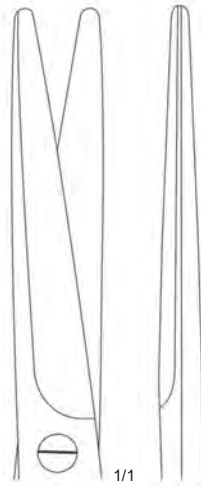

BC-02-116
 17 cm, 6¾"

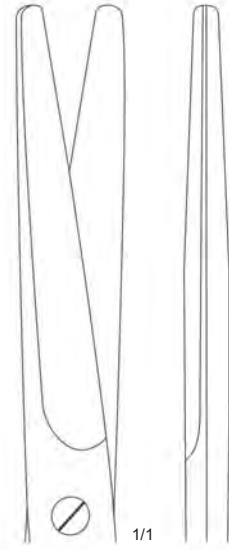

BC-02-118
 23 cm, 9"

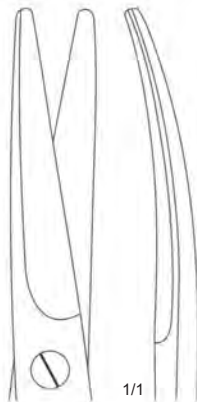

BC-02-115
 14.5 cm, 5¾"

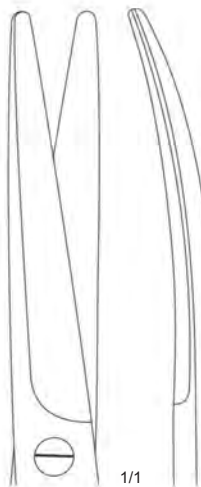

BC-02-117
 17 cm, 6¾"

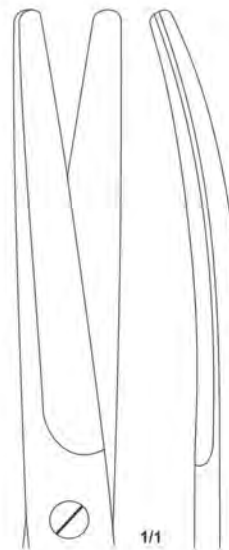

BC-02-119
 23 cm, 9"



Mayo

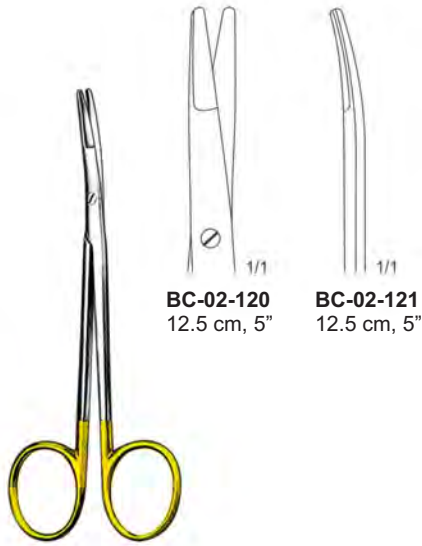

BC-02-120
12.5 cm, 5"

BC-02-121
12.5 cm, 5"

Ragnell



BC-02-122
16 cm, 6 1/4"

BC-02-123
16 cm, 6 1/4"

Lexer

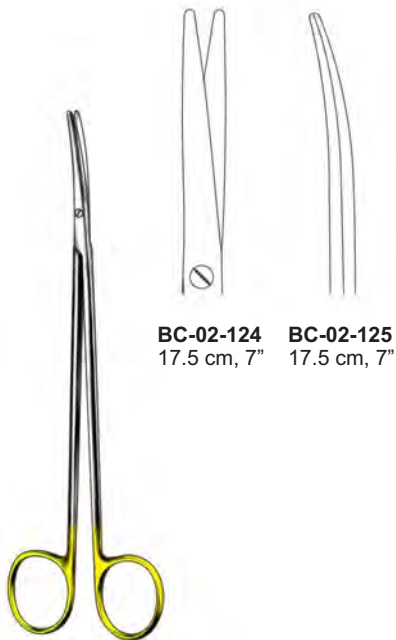

BC-02-124
17.5 cm, 7"

BC-02-125
17.5 cm, 7"

Toennis-Adson

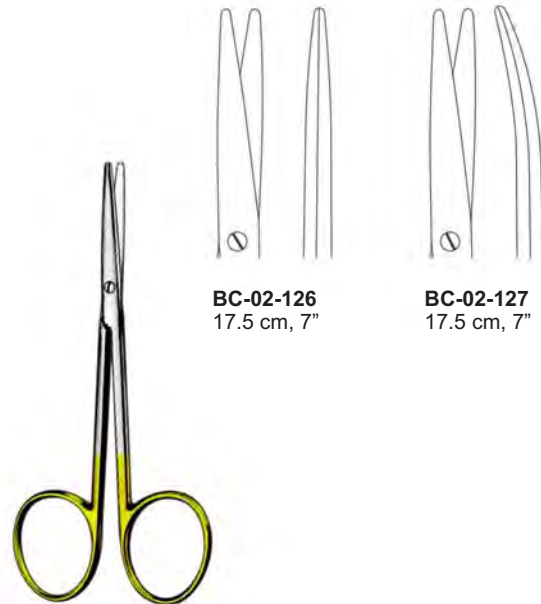

BC-02-126
17.5 cm, 7"

BC-02-127
17.5 cm, 7"

Metzenbaum



Mayo-stille

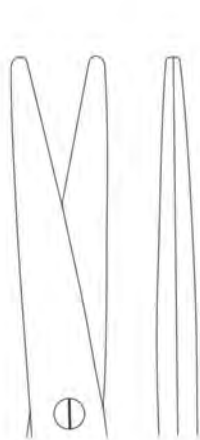

BC-02-128
14.5 cm, 5¾"

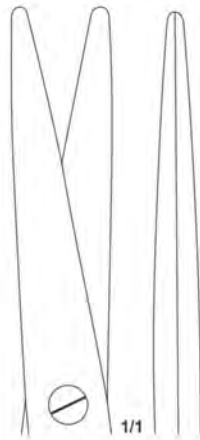

BC-02-129
17 cm, 6¾"

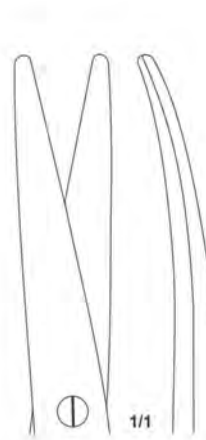

BC-02-130
14.5 cm, 5¾"

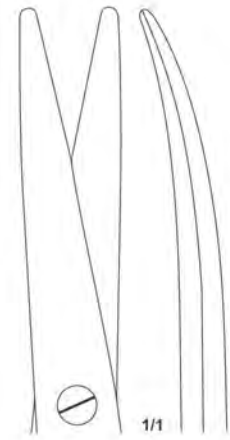

BC-02-131
17 cm, 6¾"



Mayo-lexer

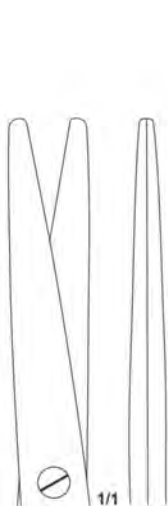

BC-02-132
16 cm, 6¼"

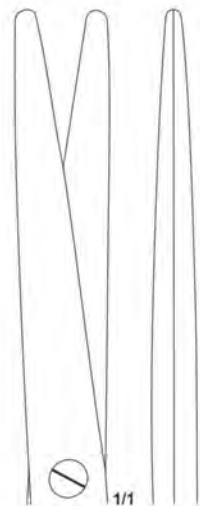

BC-02-133
21 cm, 8¼"

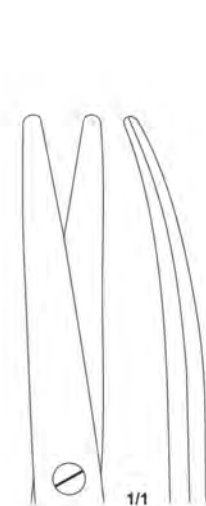

BC-02-134
16 cm, 6¼"

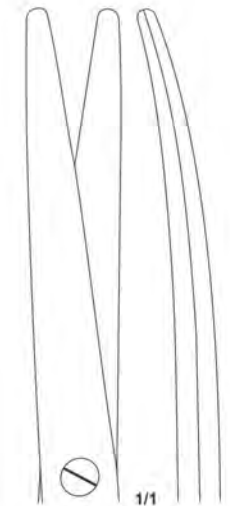

BC-02-135
21 cm, 8¼"

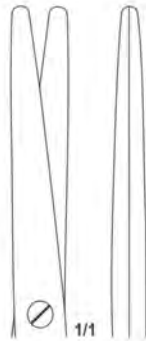

BC-02-136
14.5 cm

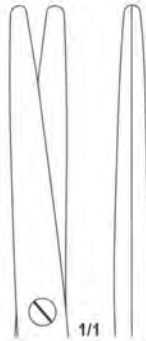

BC-02-137
18 cm

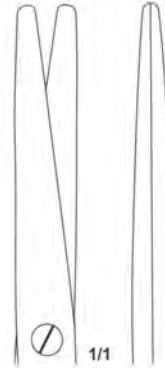

BC-02-138
20.5 cm

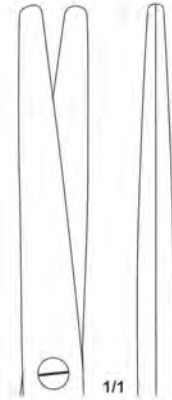

BC-02-139
23 cm

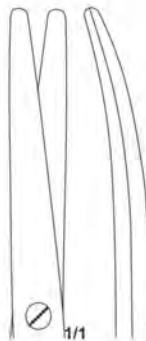

BC-02-140
14.5 cm

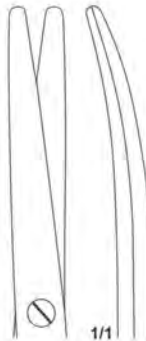

BC-02-141
18 cm

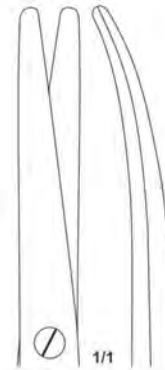

BC-02-142
20.5 cm

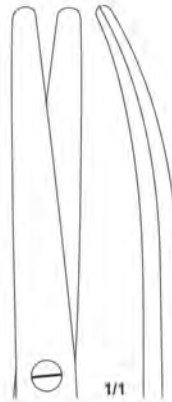

BC-02-143
23 cm



Metzenbaum
Standard Patterns
Modelos Standard
Modèlos Standard

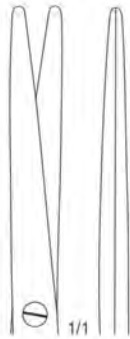

BC-02-144
14.5 cm

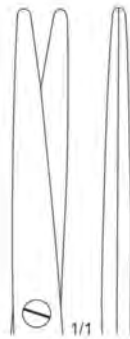

BC-02-145
18 cm

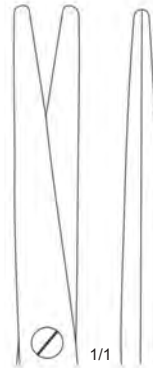

BC-02-146
20.5 cm

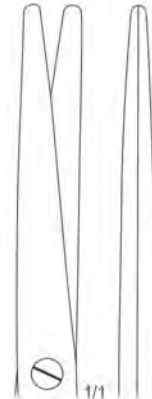

BC-02-147
23 cm

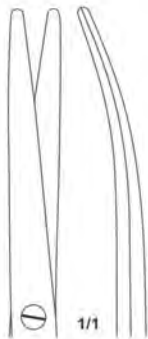

BC-02-148
14.5 cm

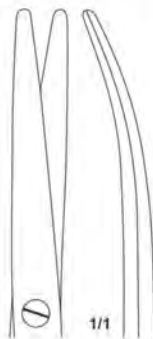

BC-02-149
18 cm

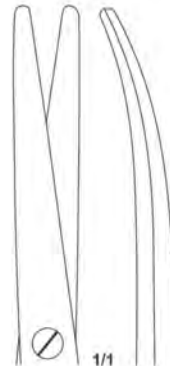

BC-02-150
20.5 cm

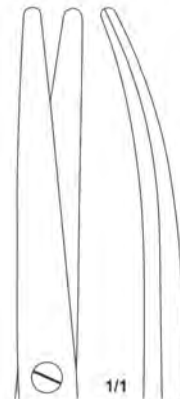

BC-02-151
23 cm



Metzenbaum
delicate patterns
modelos finos
modèls fino

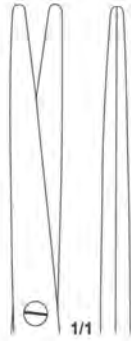

BC-02-152
14.5 cm, 5¾"

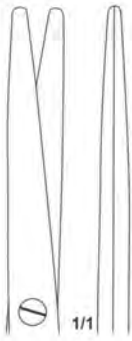

BC-02-153
18 cm, 7"

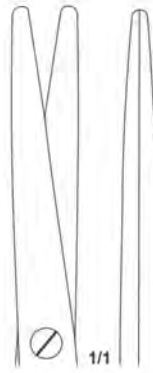

BC-02-154
20.5 cm, 8"

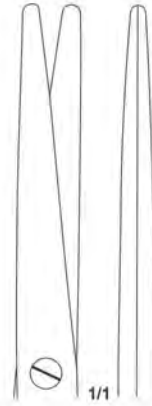

BC-02-155
23 cm, 9"

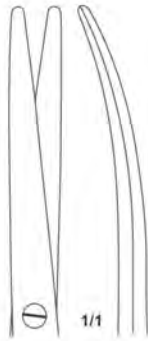

BC-02-156
14.5 cm, 5¾"

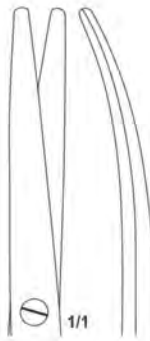

BC-02-157
18 cm, 7"

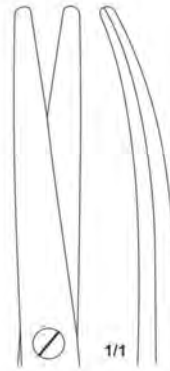

BC-02-158
20.5 cm, 8"

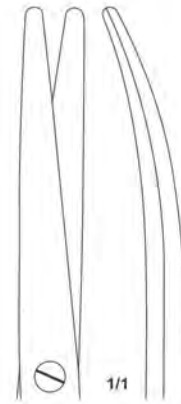

BC-02-159
23 cm, 9"



Metzenbaum
Very Delicate Patterns
Modelos Muy Finos
Modèlos Très Fino

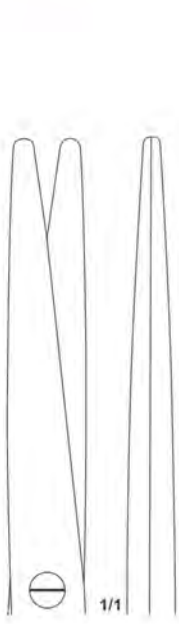

BC-02-160 26.0 cm, 10¼"
BC-02-161 28.0 cm, 11¼"

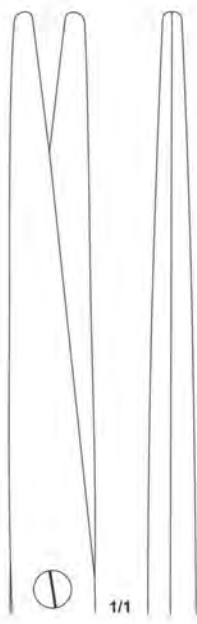

WI-02-162
 31 cm, 12¼"

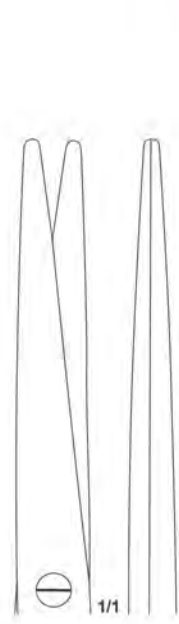

BC-02-166 26.0 cm, 10¼"
BC-02-167 28.0 cm, 11¼"

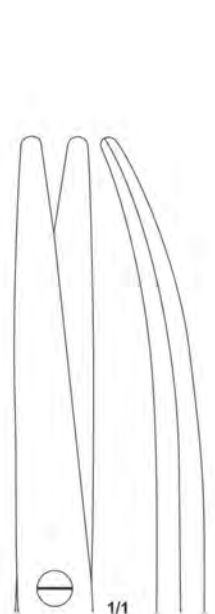

BC-02-163 26.0 cm, 10¼"
BC-02-164 28.5 cm, 11¼"

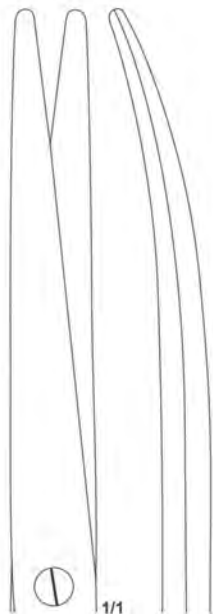

BC-02-165
 31 cm, 12¼"

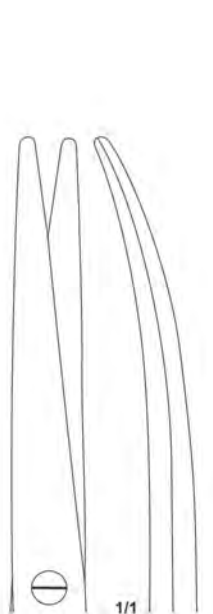

BC-02-168 26.0 cm, 10¼"
BC-02-169 28.5 cm, 11¼"



Nelson-Metzenbaum
 Standard Patterns
 Modelos Standard
 Modèlos Standard



Nelson-Metzenbaum
 Delicate Patterns
 Modelos Finos
 Modèlos Fino



Metzenbaum

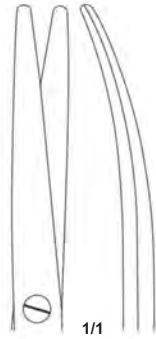

BC-02-170
18 cm, 7"

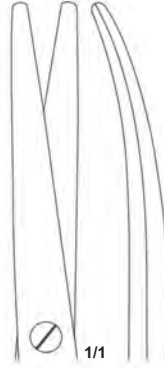

BC-02-171
20.5 cm, 8"

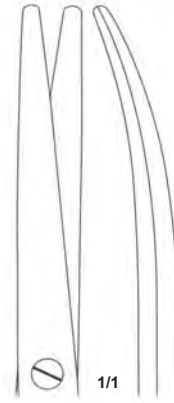

BC-02-172
23 cm, 9"

Dissecting Scissors • Tijeras de diseccion • Ciseaux á dissection •



Metzenbaum-Thorek

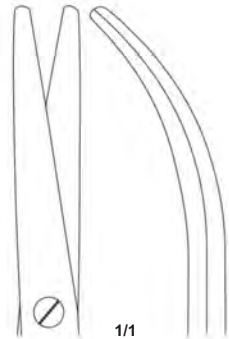

BC-02-173
20 cm, 8"

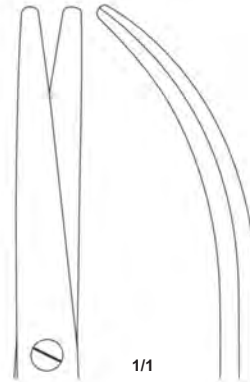

BC-02-174
22.5 cm, 9"

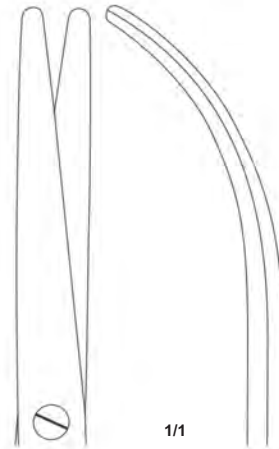

BC-02-175
27.5 cm, 10¾"

• Adnex Scissors • Tijeras adnex • Ciseaux adnex •

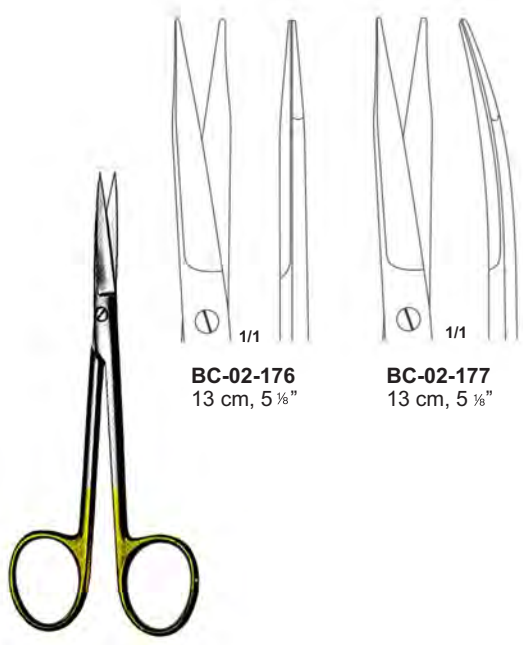

BC-02-176
 13 cm, 5 1/8"

BC-02-177
 13 cm, 5 1/8"

GoldmannFox

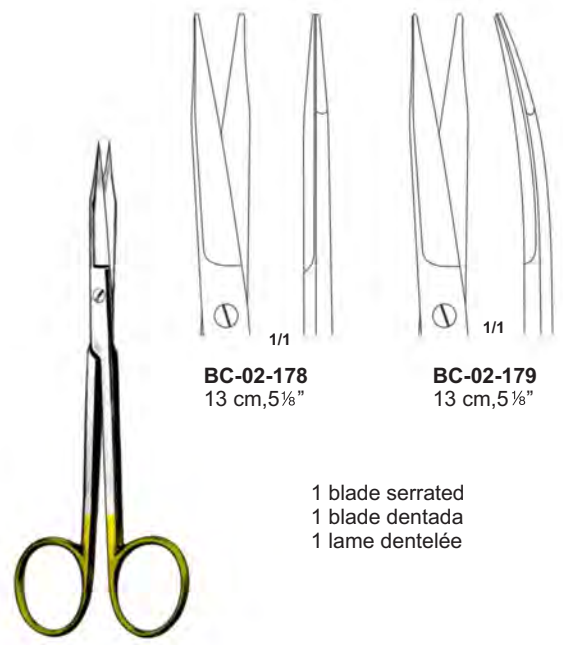

BC-02-178
 13 cm, 5 1/8"

BC-02-179
 13 cm, 5 1/8"

Goldmann-Fox

1 blade serrated
 1 blade dentada
 1 lame dentelée

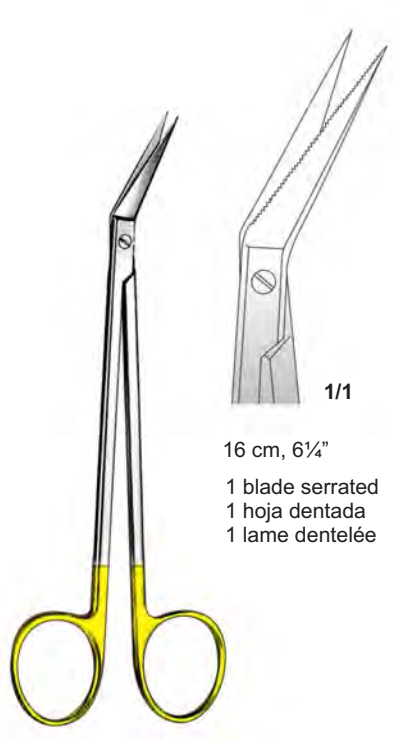

16 cm, 6 1/4"
 1 blade serrated
 1 hoja dentada
 1 lame dentelée

Locklin
BC-02-180

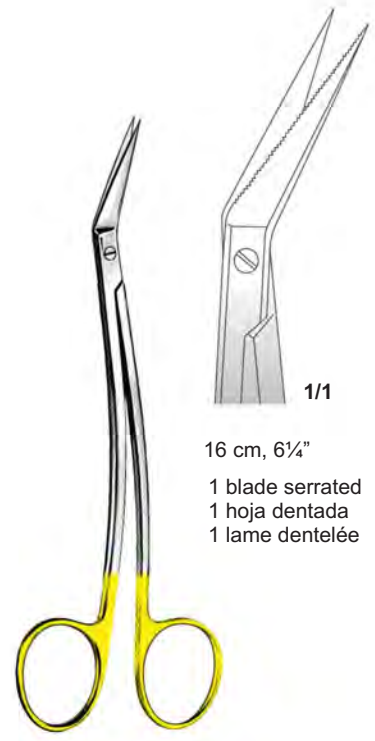

16 cm, 6 1/4"
 1 blade serrated
 1 hoja dentada
 1 lame dentelée

Locklin
BC-02-181

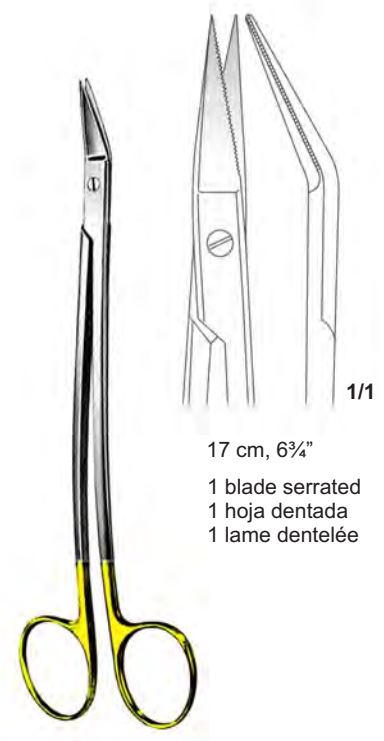

17 cm, 6 3/4"
 1 blade serrated
 1 hoja dentada
 1 lame dentelée

Dean
BC-02-182



BC-02-183
19 cm, 7½"



BC-02-186
23 cm, 9"



BC-02-184
18.5 cm, 7½"

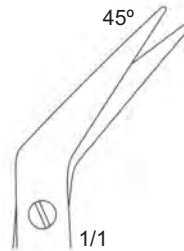

BC-02-187
22.5 cm, 9"



De Bakey

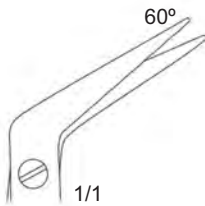

BC-02-185
18 cm, 7"

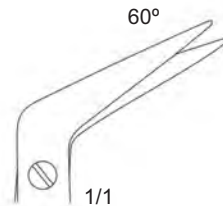

BC-02-188
22 cm, 8¾"



De Bakey



BC-02-189
 18 cm, 7"



BC-02-190
 18 cm, 7"



BC-02-191
 17.5 cm, 7"

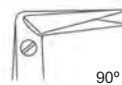

BC-02-192
 17 cm, 6 3/4"



BC-02-193
 17 cm, 6 3/4"



Hegemann-Dietrich



BC-02-194
 19 cm, 7 1/2"

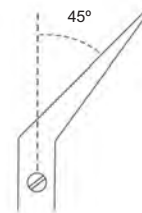

BC-02-195
 18.5 cm, 7 1/4"

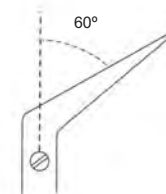

BC-02-196
 18 cm, 7"

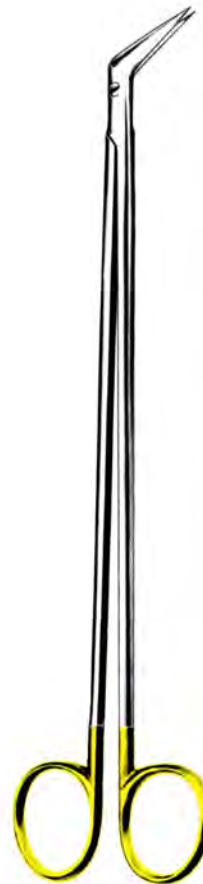

Potts-Smith



1 blade serrated
1 hoja dentada
1 lame dentelée

Knight
BC-02-197
17.5 cm, 7"

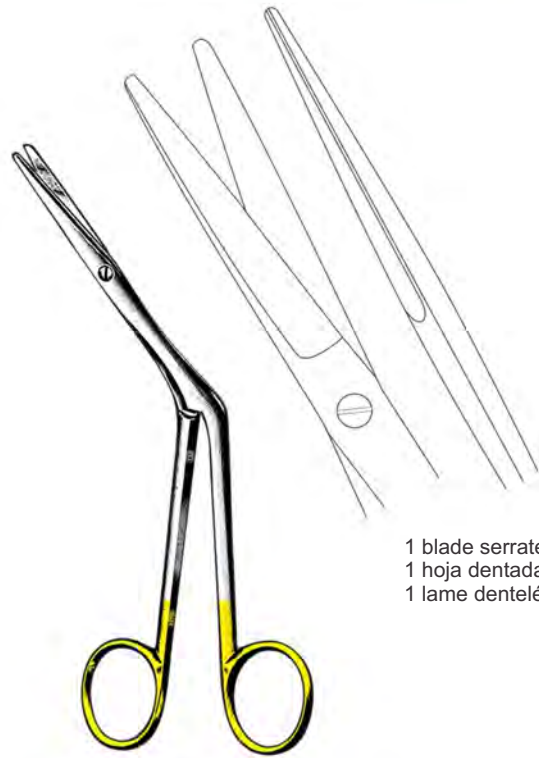

1 blade serrated
1 hoja dentada
1 lame dentelée

Heymann
BC-02-198
18.5 cm, 7 1/4"



1 blade serrated
1 hoja dentada
1 lame dentelée

Fonon
BC-02-199
13.5 cm, 5 1/4"



1 blade serrated
1 hoja dentada
1 lame dentelée

Cottle
BC-02-200
16 cm, 6 1/4"



Caplan
BC-02-201
20 Cm, 8"

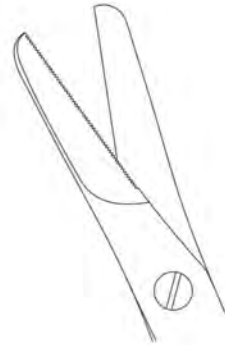

Septum scissors, serrated
Tijera para el tabique nasal, dentada
Ciseaux dentelés pour septum



Gorney
BC-02-202
21.5 cm, 8½"

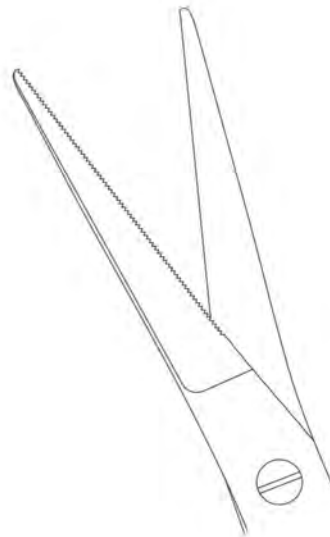

Septum scissors, serrated
Tijera para el tabique nasal, dentada
Ciseaux dentelés pour septum



Sims

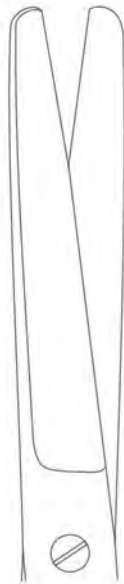

BC-02-203
23 cm, 9"



BC-02-204
20 cm, 8"

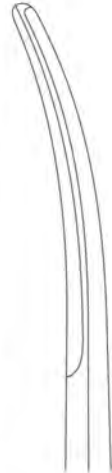

BC-02-205
20 cm, 8"

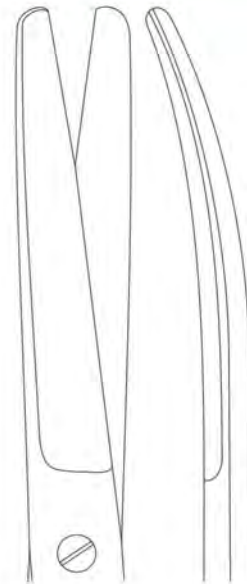

BC-02-206
23 cm, 9"

Uterine scissors • Tijeras uterinas • Ciseaux utérins

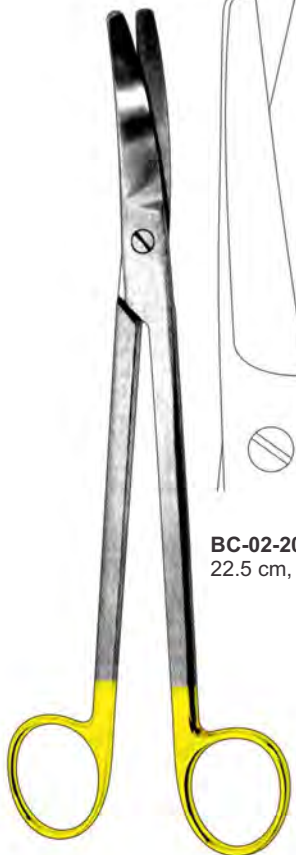

BC-02-207
22.5 cm, 9"



BC-02-208
22.5 cm, 9"

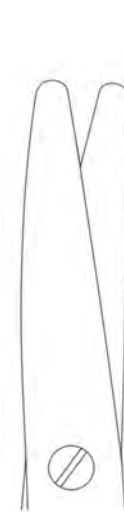

BC-02-209
22 cm, 8 3/4"

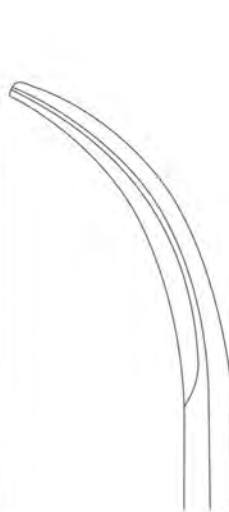

BC-02-210
22 cm, 8 3/4"

Parametrium scissors
Tijeras parametrium
Ciseaux à ligaments larges

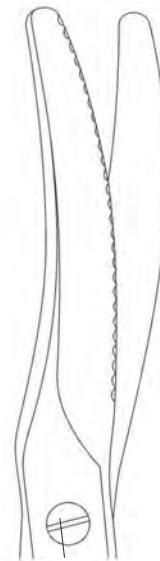
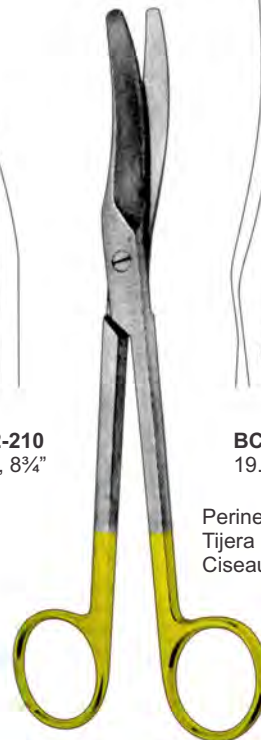

BC-02-211
19.5 cm, 7 3/4"

Perineum (episiotomy) scissors
Tijera para perineo (para episiotomia)
Ciseaux à épisiotomie



**WELMED Instrument Company
Defence Road, Near Wapda Grid Station
Sialkot 51310, Pakistan.**

Phone : +92 52 3554782, 3558704

Fax : +92 52 3550296

☎ Mobile : +92 333 8680640

Email : welmedpk@gmail.com

info@welmedinst.com

wmm@brain.net.pk

welmed@cyber.net.pk

Website : www.welmedinst.com