



Serving Humanity Since 1908

WELMED
INSTRUMENTS CO.

**Retractors Catalogue
Group 12 & 13**



Manufacturers & Exporters of Quality Surgical Instruments

Self-Retaining and Abdominal Retractors



Retractors 12 & 13

WELMED Instruments Company
Defence Road
Near Wapda Grid Colony
Sialkot 51310, Pakistan.

Phone : +92 52 3554782, 3558704
Fax : +92 52 3550296
Cell : +92 333 8680640

Email : info@welmedinst.com
welmedpk@gmail.com
wmm@brain.net.pk
welmed@cyber.net.pk

Website : www.welmedinst.com

About Us

Quality begins at **WELMED** Instruments Company where master craftsmen forge and manufacture each instrument to its exact specifications and measurements. Instruments must undergo a series of quality control inspections in order to be worthy of **WELMED** name and warranty. We offer a wide selection of medical instruments including Surgical and Dental instruments.

We have acquired a unique and unmatched understanding of manufacturing through a large experience, working since 1908. Years of experience & state of the art manufacturing facilities helped us to keep our prices low. Our Surgical & Dental instruments are created by expert craftsmen, providing unfaltering quality you can rely on.

We have launched a fully interactive website where you can get online and track your orders 24 hours a day, 7 days in a week, and 365 days a year. Ask for our free e-catalogue on CD-Rom to save time and enjoy hassle free ordering.

We provide our customers with most reliable customer service as your satisfaction is our top priority. Our customers always enjoy our wonderful customer service and quality tools at the best price.

Lastly we invite you to have a work experience with **WELMED** Instruments Company and we will prove ourselves as one of the most valuable source you have.

You can find us at

WELMED Instruments Company
Defence Road, Near Wapda Grid Colony
Sialkot 51310, Pakistan.

Phone : +92 52 3554782, 3558704
Fax : +92 52 3550296
Cell : +92 333 8680640

Emails :
Info@welmedinst.com
welmedpk@gmail.com
wmm@brain.net.pk
welmed@cyber.net.pk

Website : www.welmedinst.com



History

WELMED Instruments Company was founded in 1995. Our Great Grandfather **Mian Muhammad Fazal Elahi** was the founder of M/s M.F. Elahi & Company (E.P.) Pvt. Ltd, established in 1908. WELMED is a sister concern of M.F. Elahi & Co. It is our pride to be a member of M.F. Elahi Family.

WELMED Instruments Company is located in the heart of beautiful city, Sialkot, Pakistan. We are manufacturers and exporters of quality Surgical, Dental instruments and Scissors of all sorts in various categories. We are closely attached with highly skilled surgeons and other technicians of the surgical industry to make the new instruments development possible.

WELMED is in a continues process of development and testing of new instruments for their precision and perfect functioning. We are also working at imported forging supply by foreign customers.

Certificates

Welmed Instruments Company has achieved the certificates for ISO-9001, ISO-13485, cGMP (FDA) and CE Marking.

Quality Control

All material use in the manufacturing of our instruments are tested from relevant laboratories. Our continuous quality control is our best warranty so that you built confidence in our products.

Deliveries

Deliveries are quick and in-time.

Mode Of Payment

Terms of Payment is ADVANCE or LETTER OF CREDIT (Irrevocable)

Quality Policy

WELMED Instruments Company aims to produce quality Surgical, Dental instruments and Scissors of all sorts at reasonable prices to become an exemplary manufacturer. Our total emphasize is to achieve customer's satisfaction by clearly understanding their requirements and following a quality management system which is a primary concern of all our work force. We do our best to produce instruments of finest quality.



Warranty

All WELMED Instruments are produced from finest stainless steel available to be free from any defect in material or workmanship. Any product that proves to be defective in material or workmanship will either be repaired or replaced without any charge. This warranty is void if the instrument is abused, altered, modified or is not used in the manner for which it is intended.

Retractors

12

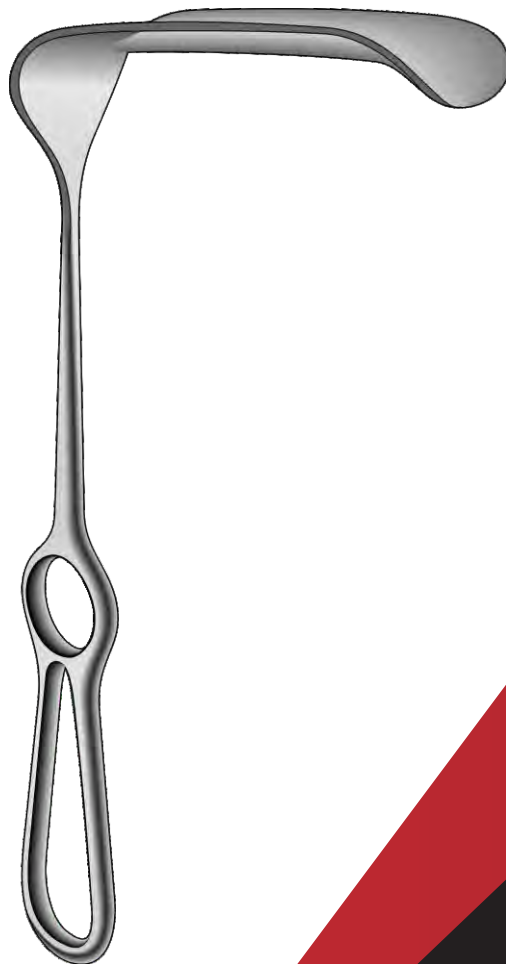

WELMED
INSTRUMENTS CO.

| | | | |
|------------------------------|----------------|-----------------------|-------|
| Abdominal Intestinal Spatula | 50 | Marberge (Gil-Vernet) | 08 |
| Adson | 01 | Martin | 40 |
| Allison | 44 | Mathieu | 12,16 |
| Baby-Roux | 14 | Mayo | 34 |
| Brunner | 37-38 | Meyerding | 11 |
| Casper | 01,30 | Middeldorpf | 28 |
| Collin | 13 | Mikulicz | 39 |
| Collin-Hartmann | 15 | Mini-Langenbeck | 10 |
| Coryllos | 43 | Moberg | 10 |
| Cottle | 03,04 | Moldestad | 03 |
| Cottle-Neivert | 07 | News Ret. | 03 |
| Crile | 13 | O'connor | 03 |
| Cushing | 04,08,09 | Obwegeser | 26 |
| Davidson | 44 | Ollier | 22 |
| Deaver | 47-48 | Parker | 14 |
| Desmarres | 09 | Parker-Langenbeck | 16 |
| Dockhorn | 30 | Parker-Mott | 14 |
| Doyen | 33,34 | Paul | 11 |
| Doyen-Stille | 32 | Ragnell-Davis | 12 |
| Emmet | 07 | Reverdin | 51 |
| Farabeuf | 13 | Richardson | 36 |
| Fomon | 07 | Richardson-Eastman | 35 |
| Ford-Deaver | 46 | Rollet | 04 |
| Foss | 46 | Rose | 13 |
| Frazier | 02 | Roux | 15 |
| Freer | 04 | Sachs | 03,07 |
| Fritsch | 35 | Sauerbruch | 27 |
| Gillies (Converse) | 02 | Semb | 44 |
| Gillies | 02 | Senn-Green | 10 |
| Goelet | 15 | Senn-Miller | 12 |
| Graefee (Tyrell) | 02 | Simon | 07,40 |
| Grahm | 03 | St-marks | 41 |
| Green | 28 | Strandell-Stille | 11 |
| Groningen | 01 | Trachea Ret. | 05,06 |
| Guthrie | 04 | Tuffier | 51 |
| Haberer | 51 | Us-Army | 09 |
| Harrington | 45 | Volkman | 17-19 |
| Heaney-Simon | 40 | Zenker | 42 |
| Hibbs | 16 | | |
| Hosel | 31 | | |
| Israel | 21 | | |
| Jackson | 12 | | |
| Jackson | 03 | | |
| Joseph | 03,05 | | |
| Kader | 52 | | |
| Kelly | 36,39 | | |
| Kilner | 02 | | |
| Kirklin | 08 | | |
| Klapp | 11 | | |
| Knapp | 04 | | |
| Kocher | 17,20,27,29,49 | | |
| Kocher-Langenbeck | 24 | | |
| Koerte | 22 | | |
| Krayenbuhl | 01 | | |
| Lahey | 10,05 | | |
| Langenbeck | 23-25 | | |
| Legueu | 49 | | |
| Luer | 13 | | |



Krayenbuhl



BC-12-101
18.5 cm



BC-12-102
18.5 cm



BC-12-103
18.5 cm



BC-12-104
18.5 cm



Adson



BC-12-105
20 cm
sharp
agudo
pointu



BC-12-106
20 cm
blunt
romo
mousse



Caspar
Exploration and coagulation hook, insulated
Ganchos para exploracion y coagulacion, aislados
Crochet pour exploration et coagulation, isoles



BC-12-107
25 cm



BC-12-108
25 cm



BC-12-109
25 cm



BC-12-110
25 cm



BC-12-111
26 cm



BC-12-112
26 cm

Groningen



BC-12-113
12 cm
sharp
aguda
pointu

Graefe (Tyrell)

Skin retractors (iris hook)
Ganchos para piel (gancho para iris)
Crochets a peau (Iris)



BC-12-114
12 cm
blunt
romo
mousses



Frazier
BC-12-115
12.5 cm
Dura and skin retractor,sharp
Gancho para piel y dura-madre,agudo
Crochet a peau et a dure-mere, pointu



Kilner
BC-12-116
13 cm
skin retractor,sharp
Gancho para piel ,agudo
Crochet a peau, pointu



Kilner
BC-12-117
15 cm
skin retractor,sharp
Gancho para piel ,agudo
Crochet a peau, pointu



Gillies
BC-12-118
18 cm
skin retractor,sharp
Gancho para piel ,agudo
Crochet a peau, pointu



Gillies (converse)
Dura and skin retractor,sharp
Gancho para piel y dura-madre,agudo
Crochet a peau et a dure-mere, pointu



BC-12-119
18.5 cm



BC-12-120
18.5 cm



Moldestad
BC-12-121
12 cm
vein retractor
Separador para venas
Ecarteur a veines



O'Connor
BC-12-122
12.5 cm
Skin retractor (Iris hook), sharp
Gancho para piel (gancho para iris)
agudo
Crochet a peau (Iris), pointu



Cottle
BC-12-123
16 cm
Dura and skin retractor, sharp
Gancho para piel y dura-madre, agudo
Crochet a peau et a dure-mere, pointu



Joseph
BC-12-124
16 cm
Hook for plastic surgery,
sharp
Gancho para cirugia plastica,
agudo
Crochet pour la chirurgie plastique,
pointu



Graham
BC-12-125
17 cm
Dura hook, blunt
Gancho para dura-madre,
romo
Crochet pour la dure-mere,
mousse



Sachs
BC-12-126
18.5 cm
Dura hook, sharp
Gancho para dura-madre,
agudo
Crochet pour la dure-mere,
pointu



News
BC-12-127
14.5 cm
Trachea retractor, sharp
Separador para la traquea,
agudo
Ecarteur pour tracheotomie,
pointu



Jackson
BC-12-128
14 cm
Trachea retractor, sharp
Separador para la traquea, agudo
Ecarteur pour tracheotomie, pointu



Cushing
BC-12-129
14 cm
Dura hook, sharp
Gancho para dura-madre
agudo
Crochet pour la dure-mere,
pointu



Cottle
BC-12-130
17 cm
Hook for plastic surgery, sharp
Gancho para cirurgia plastica,
agudo
Crochet pour la chirurgie plastique,
pointu



Guthrie
BC-12-131
12.5 cm
Skin retractor (Iris hook), sharp
Gancho para piel (gancho
para iris), agudo
Crochet a plaies (Iris),Pointu



Guthrie
BC-12-132
13 cm
Skin retractor (Iris hook), sharp
Gancho para piel (gancho
para iris), agudo
Crochet a plaies (Iris),Pointu



Rollet
BC-12-133
13.5 cm
sharp
agudo
pointu



Knapp
BC-12-134
13.5 cm
blunt
romo
mousse



Freer
BC-12-135
15 cm
sharp
agudo
pointu



Knapp
BC-12-136
16 cm
sharp
agudo
pointu



Lahey
sharp
agudo
pointu

BC-12-137
12 cm

BC-12-138
12 cm

BC-12-139
16 cm

BC-12-140
16 cm

BC-12-141
16 cm

BC-12-142
16 cm

Joseph
Hook for plastic surgery, sharp
gancho para cirugia plastica, agudas
Crochet pour la chirurgie plastique, pointu

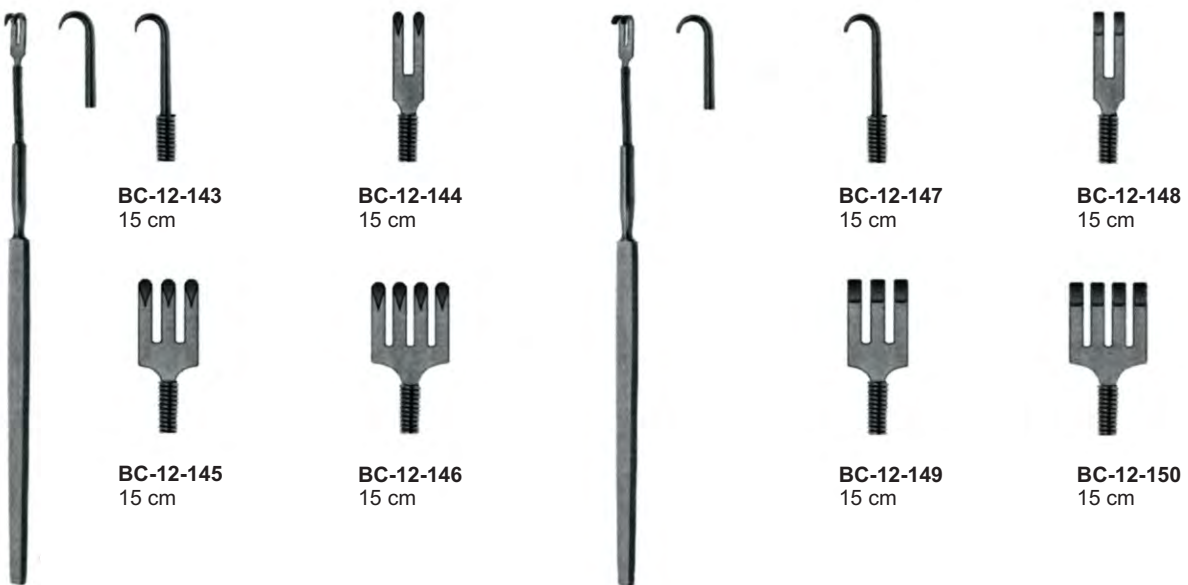

BC-12-143
15 cm

BC-12-144
15 cm

BC-12-147
15 cm

BC-12-148
15 cm

BC-12-145
15 cm

BC-12-146
15 cm

BC-12-149
15 cm

BC-12-150
15 cm

Trachea retractors, sharp / flexible
Separadores para la traquea, agudos / flexibles
Ecarteurs pour tracheotomie, pointu, / flexible

Trachea retractors, blunt / flexible
Separadores para la traquea, romos / flexibles
Ecarteurs pour tracheotomie, mousse, / flexible



BC-12-151
16.5 cm



BC-12-152
16.5 cm



BC-12-155
16.5 cm



BC-12-156
16.5 cm



BC-12-153
16.5 cm



BC-12-154
16.5 cm



BC-12-157
16.5 cm



BC-12-158
16.5 cm

Trachea retractors, sharp
Separadores para la traquea, agudos
Ecarteurs pour tracheotomie, pointu

Trachea retractors, blunt
Separadores para la traquea, romos
Ecarteurs pour tracheotomie, mousse



BC-12-159
17 cm



BC-12-160
17 cm



BC-12-163
17 cm



BC-12-164
17 cm



BC-12-161
17 cm



BC-12-162
17 cm



BC-12-165
17 cm



BC-12-166
17 cm

Trachea retractors, sharp
Separadores para la traquea, agudos
Ecarteurs pour tracheotomie, pointu

Trachea retractors, blunt
Separadores para la traquea, romos
Ecarteurs pour tracheotomie, mousse



Sachs
BC-12-167
 21.5 cm
 Fistula hook
 Gancho para fistulas
 Crochet para fistules



Emmet
BC-12-168
 22 cm
 Fistula hook
 Gancho para fistulas
 Crochet para fistules



Simon
BC-12-169
 22 cm
 Fistula hook
 Gancho para fistulas
 Crochet para fistules



Fomon
BC-12-170
 16 cm
 Hook for posterior nares
 Gancho para las coanas
 Crechet nasal



Fomon
BC-12-171
 16 cm
 Hook for posterior nares
 Gancho para las coanas
 Crechet nasal



Cottle-Neivert
BC-12-172
 20.5 cm
 Hook for posterior nares with saw
 or knife guide
 Gancho para las coanas con guia
 para sierra o para cuchillo
 Crochet nasal avec scie ou
 couteau guides



11 x 12 mm (AXB)

Cushing
BC-12-173
22.5 cm
Vein retractor
Separador para venas
Ecarteur a veines



BC-12-174
8 x 5 mm (AXB)



BC-12-175
9 x 7 mm (AXB)



BC-12-176
9 x 10 mm (AXB)



BC-12-177
9 x 12 mm (AXB)



BC-12-178
10 x 15 mm (AXB)

Kirklin
13.5 cm
Vein retractor, malleable
Separadores para venas, malleable
Ecarteurs a veines, malleables



BC-12-179
8 x 8 mm (AXB)



BC-12-180
10 x 11 mm (AXB)



BC-12-181
10 x 15 mm (AXB)



BC-12-182
12 x 17 mm (AXB)



BC-12-183
13 x 20 mm (AXB)



BC-12-184
14 x 23 mm (AXB)

Marberger (Gil-Vernet)
24 cm
Vein and hilar retractor, malleable
Separadores para venas y hilares, malleable
Ecarteurs a veines et a hile renal, malleables



BC-12-185
4.5 x 8 mm (AXB)



BC-12-191
4.5 x 8 mm (AXB)



BC-12-197
4.5 x 8 mm (AXB)



BC-12-186
9 x 10 mm (AXB)



BC-12-192
9 x 10 mm (AXB)



BC-12-198
9 x 10 mm (AXB)



BC-12-187
9 x 12 mm (AXB)



BC-12-193
9 x 12 mm (AXB)



BC-12-199
9 x 12 mm (AXB)



BC-12-188
11 x 14 mm (AXB)



BC-12-194
11 x 14 mm (AXB)



BC-12-200
11 x 14 mm (AXB)



BC-12-189
12 x 16 mm (AXB)



BC-12-195
12 x 16 mm (AXB)



BC-12-201
12 x 16 mm (AXB)



BC-12-190
13 x 18 mm (AXB)



BC-12-196
13 x 18 mm (AXB)



BC-12-202
13 x 18 mm (AXB)

Desmarres
14 cm
Vein retractors (lid retractors)
Separadores para venas
(separadores para párpados)
Ecarteurs a veines (releveurs de paupieres)

Cushing
20 cm
Vein retractors
Separadores para venas
Ecarteurs a veines

Cushing
24 cm
Vein retractors
Separadores para venas
Ecarteurs a veines



Senn-Green
16 cm



BC-12-203
10 x 6 mm (AXB)



BC-12-204
20 x 6 mm (AXB)



Mini-Langenbeck
16 cm



BC-12-205
10 x 6 mm (AXB)



BC-12-206
17 x 5 mm (AXB)



BC-12-207
20 x 6 mm (AXB)



BC-12-208
22 x 8 mm (AXB)



Moberg
17.5 cm



BC-12-209
16 x 5 mm (AXB)



BC-12-210
18 x 5 mm (AXB)



BC-12-211
25 x 6 mm (AXB)



Lahey
BC-12-212
20 cm
Goitre retractor
Separador para bocio
Ecarteur a goitre



25 x 6 mm (AXB)



Paul
BC-12-213
12.5 cm
Tendon sheath retractor
Separador para vainas tendinosas
Ecarteur a gaines tendineuses



11 x 7 mm (AXB)



Klapp
17.5 cm
Tendon sheath retractor
Separador para vainas tendinosas
Ecarteur a gaines tendineuses

BC-12-214
12 x 6 mm (AXB)

BC-12-215
12 x 11 mm (AXB)

BC-12-216
15 x 11 mm (AXB)



Strandell-Stille
19 cm
Tendon sheath retractor
Separador para vainas tendinosas
Ecarteur a gaines tendineuses

BC-12-217
15 x 6 mm (AXB)

BC-12-218
15 x 6 mm (AXB)



Meyerding
17.5 cm



BC-12-219
18 x 7 mm (AXB)



BC-12-220
16 x 5 mm (AXB)



BC-12-221
7 x 4 mm (AXB)



BC-12-222
10 x 3 mm (AXB)



BC-12-223
7 x 4 mm (AXB)



BC-12-224
7 x 9 mm (AXB)

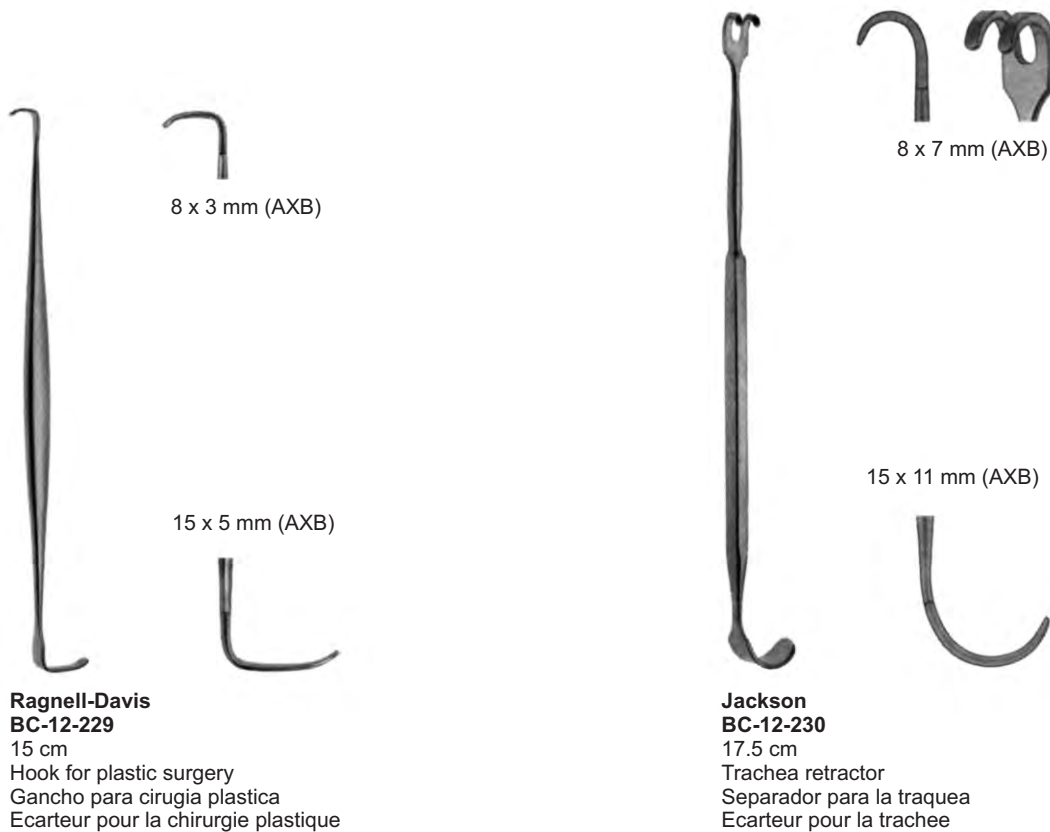
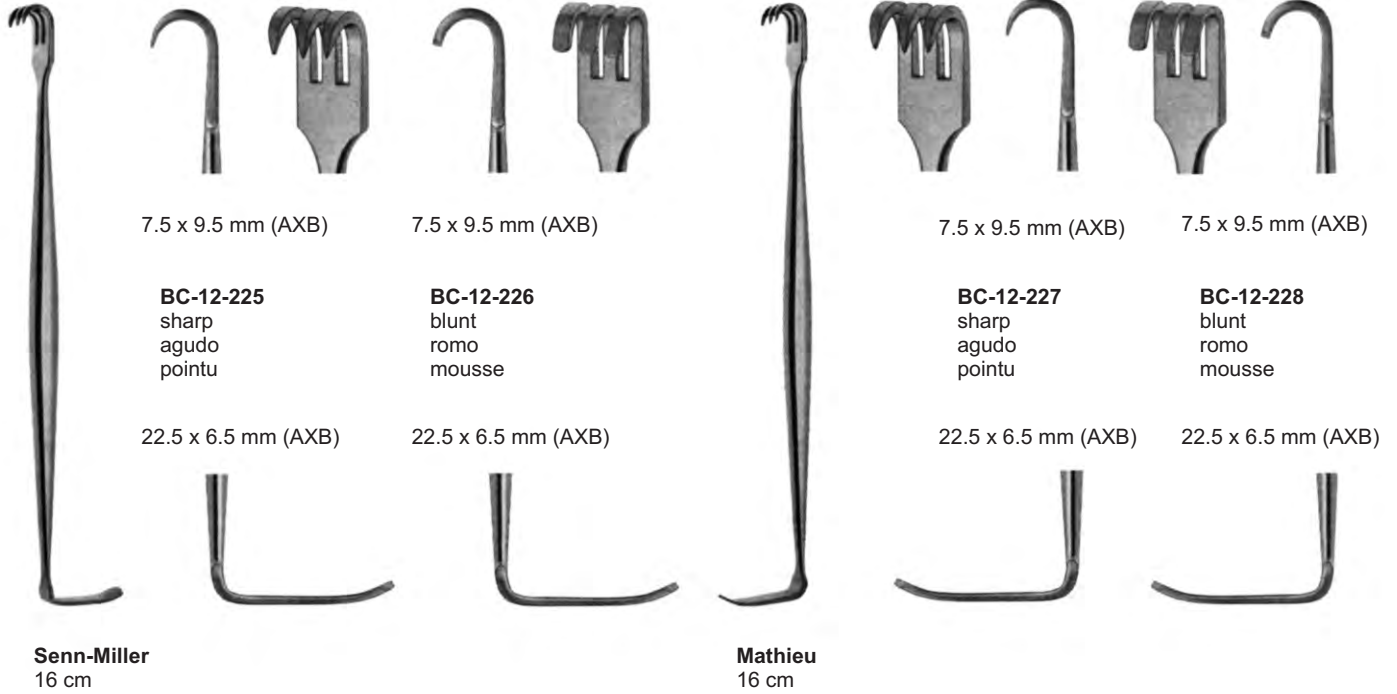

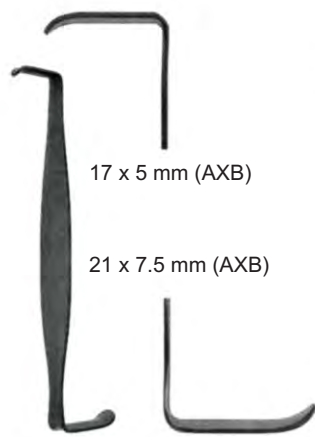

17 x 5 mm (AXB)

21 x 7.5 mm (AXB)

Crile
BC-12-231
10.5 cm

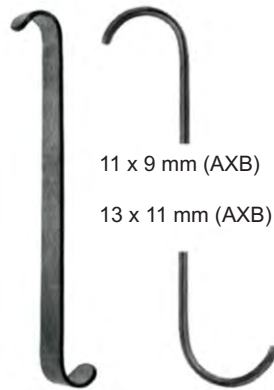

11 x 9 mm (AXB)

13 x 11 mm (AXB)

Luer
BC-12-232
11 cm

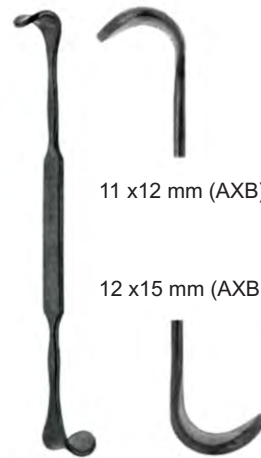

11 x 12 mm (AXB)

12 x 15 mm (AXB)

Rose
BC-12-233
13 cm

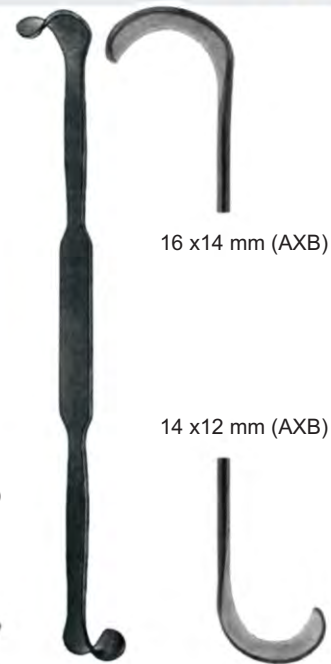

16 x 14 mm (AXB)

14 x 12 mm (AXB)

Rose
BC-12-234
19 cm



25 x 10 mm (AXB)
22 x 10 mm (AXB)

29 x 12 mm (AXB)
32 x 12 mm (AXB)

Farabeur
BC-12-235
12.5 cm
Set. Juego. jeu

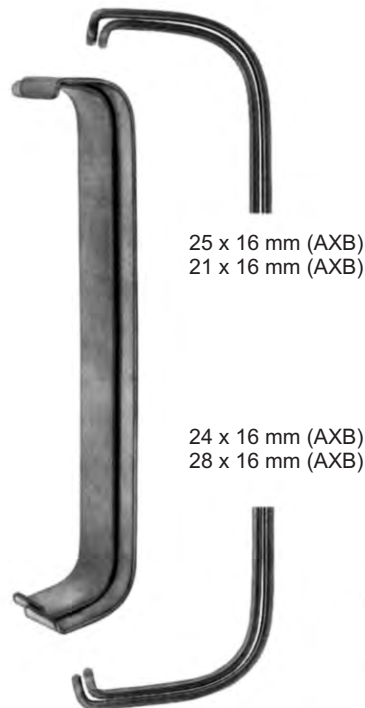

25 x 16 mm (AXB)
21 x 16 mm (AXB)

24 x 16 mm (AXB)
28 x 16 mm (AXB)

Farabeur
BC-12-236
15.5 cm
Set. Juego. jeu

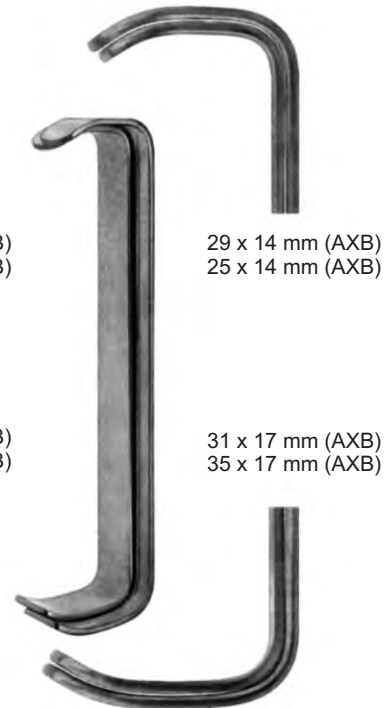

29 x 14 mm (AXB)
25 x 14 mm (AXB)

31 x 17 mm (AXB)
35 x 17 mm (AXB)

Collin
BC-12-237
14.5 cm
Set. Juego. jeu



Parker
BC-12-238
14 cm
set. Juego. jeu



24 x 15 mm (AXB)
21 x 15 mm (AXB)



21 x 15 mm (AXB)
25 x 15 mm (AXB)



Parker
BC-12-239
18 cm
set. Juego. jeu



31 x 25 mm (AXB)
27 x 25 mm (AXB)



26 x 25 mm (AXB)
30 x 25 mm (AXB)

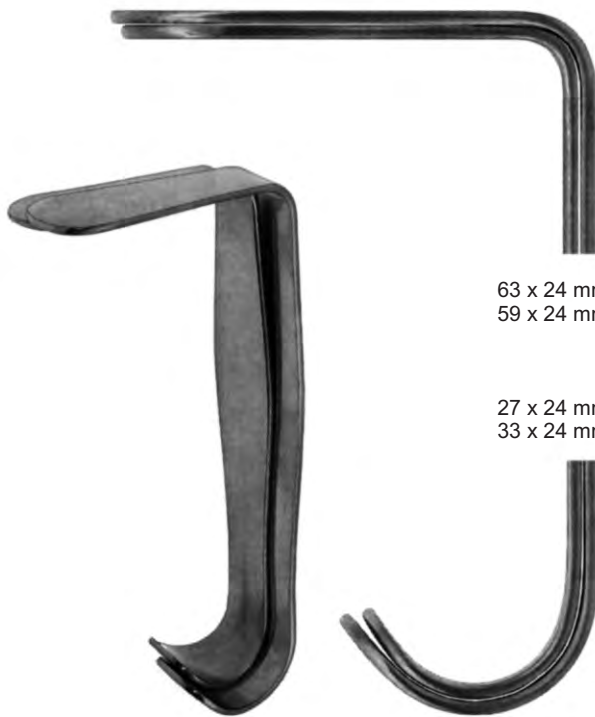

Parker-Mott
BC-12-240
14.5 cm
set. Juego. jeu

63 x 24 mm (AXB)
59 x 24 mm (AXB)

27 x 24 mm (AXB)
33 x 24 mm (AXB)



Baby-Roux
BC-12-241
12.5 cm

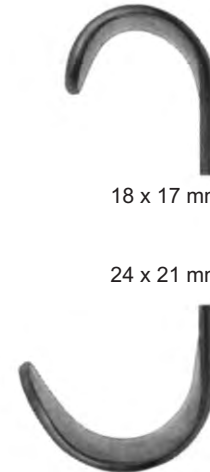

18 x 17 mm (AXB)

24 x 21 mm (AXB)



Roux
17 cm



21 x 24 mm (AXB)

BC-12-242
14.5 cm

29 x 28 mm (AXB)



27 x 26 mm (AXB)

BC-12-243
15.5 cm

32 x 37 mm (AXB)



31 x 30 mm (AXB)

BC-12-244
17 cm

36 x 42 mm (AXB)



Fig. 1



Fig. 2



Fig. 3

Set. Fig. 1-3. Juego. Fig. 1-3 Jeu. Fig. 1-3



Collin-Hartmann
BC-12-245
15.5 cm

35 x 29 mm (AXB)

50 x 35 mm (AXB)



Goelet
BC-12-246
19 cm



35 x 40 mm (AXB)



26 x 31 mm (AXB)



Mathieu
BC-12-247
20.5 cm
set. juego.jeu



50 x 13 mm (AXB)
44 x 13 mm (AXB)



40 x 26 mm (AXB)
45 x 26 mm (AXB)



Us-Army (Parker-Langenbeck)
BC-12-248
21 cm
set. Juego. jeu



32 x 15 mm (AXB)
26 x 15 mm (AXB)



40 x 15 mm (AXB)
44 x 15 mm (AXB)



BC-12-249
27 x 13 mm
(AXB)

BC-12-250
52 x 25 mm
(AXB)

BC-12-251
78 x 27 mm
(AXB)

Hibbs
BC-12-249 24.5 cm
BC-12-250 24.0 cm
BC-12-251 23.5 cm

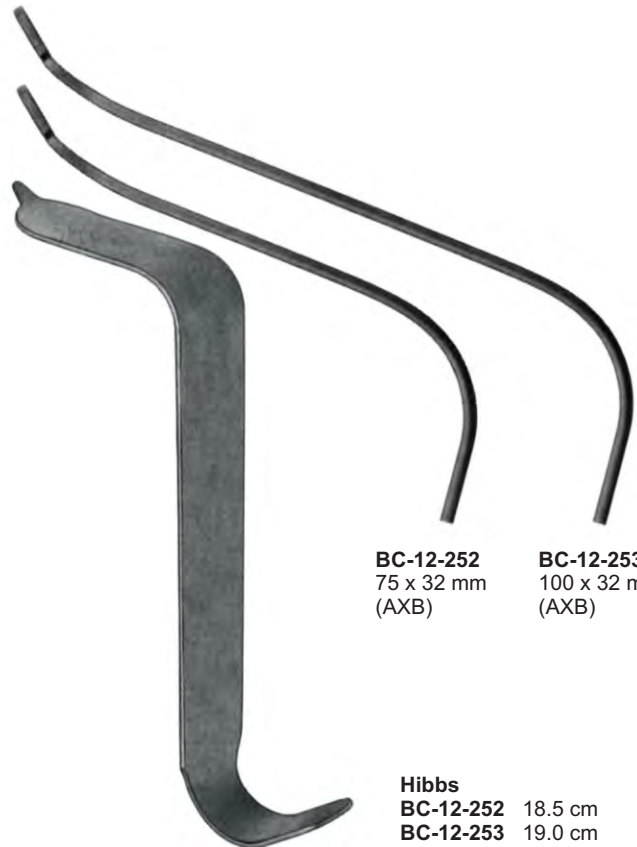

BC-12-252
75 x 32 mm
(AXB)

BC-12-253
100 x 32 mm
(AXB)

Hibbs
BC-12-252 18.5 cm
BC-12-253 19.0 cm
Spinal retractors
Separadores espinales
Ecarteurs spinal



Kocher
BC-12-254
20 cm



Sharp
agudo
pointu



Kocher



BC-12-255
22 cm
Sharp
agudo
pointu



BC-12-256
22 cm
Blunt
romo
mousse



Volkman



BC-12-257
22 cm
Sharp
agudo
pointu



BC-12-258
22 cm
Blunt
romo
mousse



Volkman



BC-12-259
22 cm
Sharp
agudo
pointu



BC-12-260
22 cm
Blunt
romo
mousse



BC-12-261
10 x 8 mm (AXB)



BC-12-262
10 x 8 mm (AXB)



BC-12-263
10 x 13 mm (AXB)



BC-12-264
10 x 13 mm (AXB)



Volkman
23 cm



BC-12-265
10 x 18 mm (AXB)



BC-12-266
10 x 18 mm (AXB)



BC-12-267
10 x 28 mm (AXB)
sharp
agudo
pointu



BC-12-268
10 x 28 mm (AXB)
blunt
romo
mousse



BC-12-269
10 x 8 mm (AXB)



BC-12-270
10 x 8 mm (AXB)



BC-12-271
10 x 8 mm (AXB)



BC-12-272
10 x 13 mm (AXB)



BC-12-273
10 x 13 mm (AXB)



BC-12-274
10 x 13 mm (AXB)



BC-12-275
10 x 18 mm (AXB)



BC-12-276
10 x 18 mm (AXB)



BC-12-277
10 x 18 mm (AXB)



BC-12-278
10 x 28 mm (AXB)



BC-12-279
10 x 28 mm (AXB)



BC-12-280
10 x 28 mm (AXB)



BC-12-281
10 x 40 mm (AXB)
sharp
agujo
pointu



BC-12-282
10 x 40 mm (AXB)
blunt
romo
mousse



Voklmann
22.5 cm

Semi-sharp
semi-agudo
semi-pointu



BC-12-283
15 x 9 mm (AXB)



BC-12-284
15 x 9 mm (AXB)



BC-12-285
15 x 9 mm (AXB)



BC-12-286
15 x 13 mm (AXB)



BC-12-287
15 x 13 mm (AXB)



BC-12-288
15 x 13 mm (AXB)



Kocher
22.5 cm



BC-12-289
15 x 18 mm (AXB)



BC-12-290
15 x 18 mm (AXB)



BC-12-291
15 x 18 mm (AXB)



BC-12-292
15 x 30 mm (AXB)
sharp
agujado
pointu



BC-12-293
15 x 30 mm (AXB)
semi-sharp
semi-agujado
semi-pointu



BC-12-294
15 x 30 mm (AXB)
blunt
romo
mousse



BC-12-295
40 x 40 mm (AXB)



BC-12-296
47 x 50 mm (AXB)



BC-12-297
53 x 60 mm (AXB)



BC-12-298
70 x 70 mm (AXB)



Israel
24.5 cm



BC-12-299
26 x 39 mm (AXB)
sharp
agudo
pointu



BC-12-300
26 x 39 mm
blunt
romo
mousse



25 x 60 mm (AXB)

BC-12-301
25 cm
sharp
agujado
pointu



38 x 56 mm (AXB)

Ollier
BC-12-302
23 cm



46 x 55 mm (AXB)

Koerte
BC-12-303
24 cm
handle vertical to the blade
mango vertical a la hoja
manche vertical a la valve



BC-12-304
30 x 10 mm (AXB)



BC-12-311
30 x 10 mm (AXB)



BC-12-305
30 x 14 mm (AXB)



BC-12-312
30 x 14 mm (AXB)



BC-12-306
30 x 16 mm (AXB)



BC-12-313
30 x 16 mm (AXB)

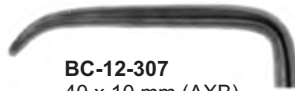

BC-12-307
40 x 10 mm (AXB)

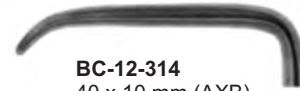

BC-12-314
40 x 10 mm (AXB)

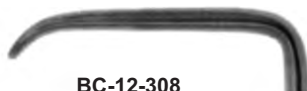

BC-12-308
42 x 13 mm (AXB)



BC-12-315
42 x 13 mm (AXB)

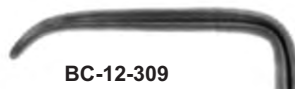

BC-12-309
40 x 15 mm (AXB)

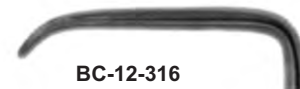

BC-12-316
40 x 15 mm (AXB)



BC-12-310
50 x 11 mm (AXB)



BC-12-317
50 x 11 mm (AXB)



Langenbeck
21.5 cm



Langenbeck
21 cm



Kocher-Langenbeck
21.5 cm



BC-12-318
25 x 6 mm (AXB)

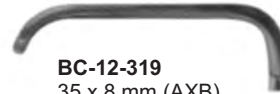

BC-12-319
35 x 8 mm (AXB)



BC-12-320
35 x 11 mm (AXB)

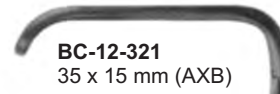

BC-12-321
35 x 15 mm (AXB)

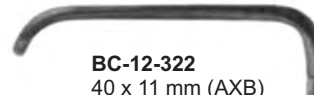

BC-12-322
40 x 11 mm (AXB)

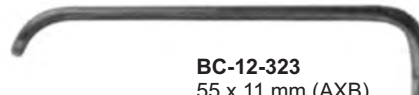

BC-12-323
55 x 11 mm (AXB)

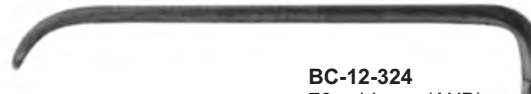

BC-12-324
70 x 14 mm (AXB)



BC-12-325
80 x 12 mm (AXB)



BC-12-326
80 x 16 mm (AXB)



BC-12-327
55 x 20 mm (AXB)



BC-12-328
60 x 20 mm (AXB)



85 x 15 mm (AXB)



Langenbeck
BC-12-327 22.5 cm
BC-12-328 21.5 cm

Langenbeck
BC-12-329
21.5 cm



Soft tissue retractors
Separadores para tejido blando
Ecarteurs pour parties molles

Obwegeser
22 cm



Soft tissue retractors
Separadores para tejido blando
Ecarteurs pour parties molles

Obwegeser
22 cm

BC-12-330
25 x 7 mm (AXB)

BC-12-331
31 x 10 mm (AXB)

BC-12-332
42 x 11 mm (AXB)

BC-12-333
55 x 12 mm (AXB)

BC-12-334
70 x 14 mm (AXB)

BC-12-335
80 x 16 mm (AXB)

BC-12-336
25 x 7 mm (AXB)

BC-12-337
31 x 10 mm (AXB)

BC-12-338
42 x 11 mm (AXB)

BC-12-339
55 x 12 mm (AXB)

BC-12-340
70 x 14 mm (AXB)

BC-12-341
80 x 16 mm (AXB)



Kocher
23 cm

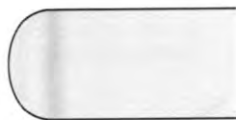

Sauerbruch
23 cm



BC-12-342
40 x 18 mm (AXB)



BC-12-343
60 x 20 mm (AXB)



BC-12-344
60 x 25 mm (AXB)

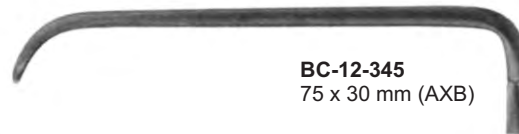

BC-12-345
75 x 30 mm (AXB)

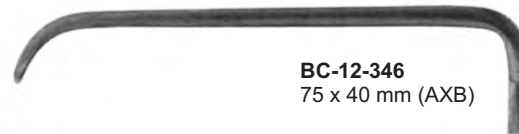

BC-12-346
75 x 40 mm (AXB)



BC-12-347
46 x 16 mm (AXB)



BC-12-348
55 x 22 mm (AXB)

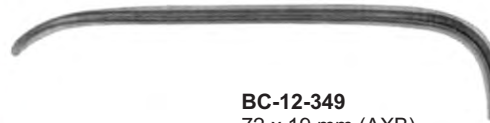

BC-12-349
72 x 19 mm (AXB)



22 x 20 mm (AXB)



Green
BC-12-350
23 cm
Thyroid gland retractors
Separador para la glandula tiroidea
Ecarteur pour la thyroïde



BC-12-351
26 x 30 mm (AXB)



BC-12-352
20 x 22 mm (AXB)



BC-12-353
15 x 16 mm (AXB)

Middeldorpf
BC-12-351 21.5 cm
BC-12-352 22.5 cm
BC-12-353 23.5 cm



BC-12-354
55 x 70 mm (AXB)



Middeldorpf
27.5 cm



BC-12-355
45 x 50 mm (AXB)



BC-12-365
45 x 45 mm (AXB)

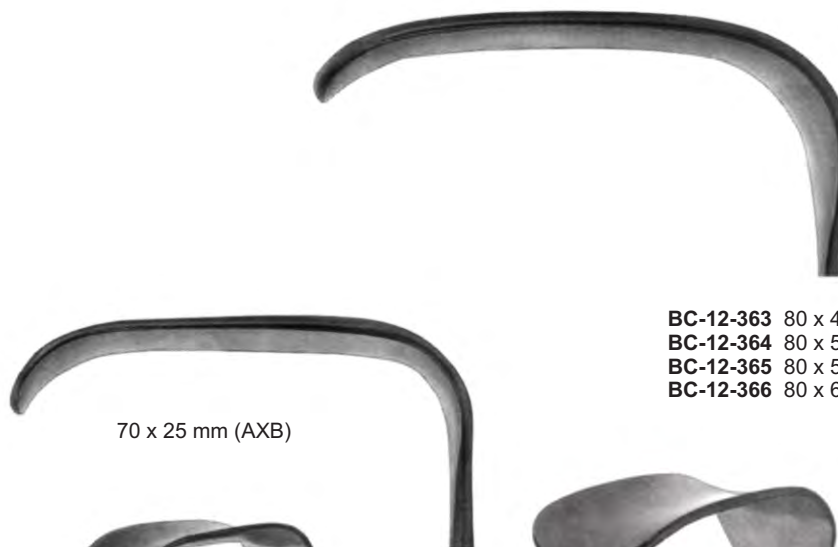

Kocher
22.5 cm



Kocher
BC-12-362
23 cm



Kocher
24.5 cm



BC-12-367
40 x 12 mm (AXB)

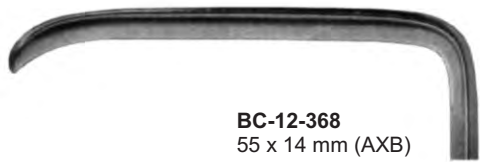

BC-12-368
55 x 14 mm (AXB)

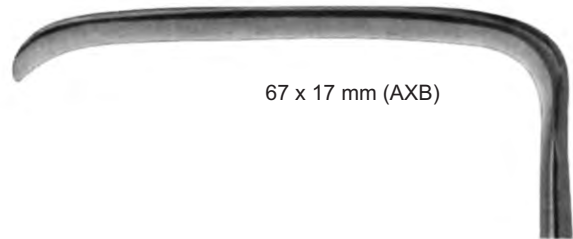

67 x 17 mm (AXB)



Dockhorn
21 cm



Caspar
BC-12-369
22.5 cm



BC-12-370
60 x 20 mm (AXB)



BC-12-371
80 x 30 mm (AXB)



BC-12-372
100 x 30 mm (AXB)



BC-12-373
120 x 30 mm (AXB)



BC-12-374 140 x 30 mm (AXB)
BC-12-375 140 x 40 mm (AXB)

Hosel
25 cm / 10"

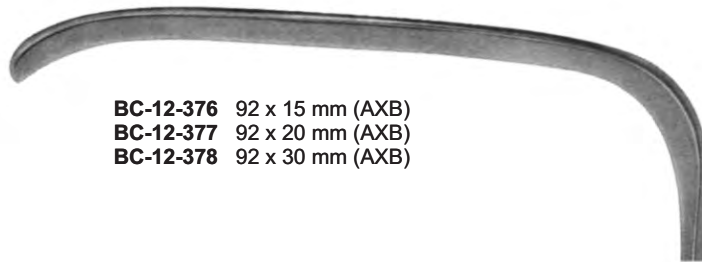

BC-12-376 92 x 15 mm (AXB)
BC-12-377 92 x 20 mm (AXB)
BC-12-378 92 x 30 mm (AXB)

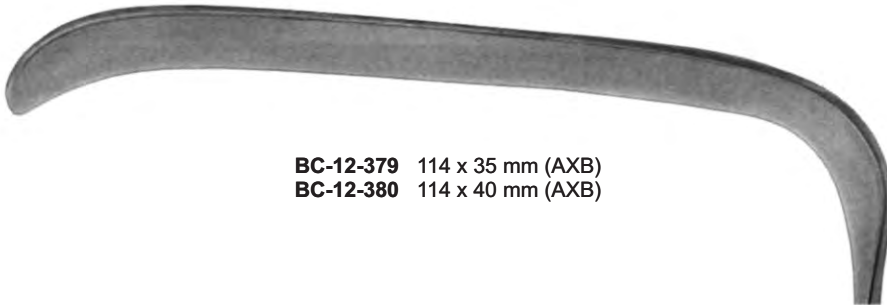

BC-12-379 114 x 35 mm (AXB)
BC-12-380 114 x 40 mm (AXB)



BC-12-381 120 x 55 mm (AXB)



Doyen-Stille
24 cm
handle vertical to the blade
mango vertical a la hoja
manche vertical a la valve

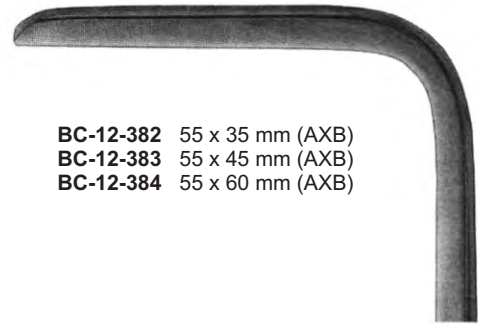

BC-12-382 55 x 35 mm (AXB)
BC-12-383 55 x 45 mm (AXB)
BC-12-384 55 x 60 mm (AXB)

1/1

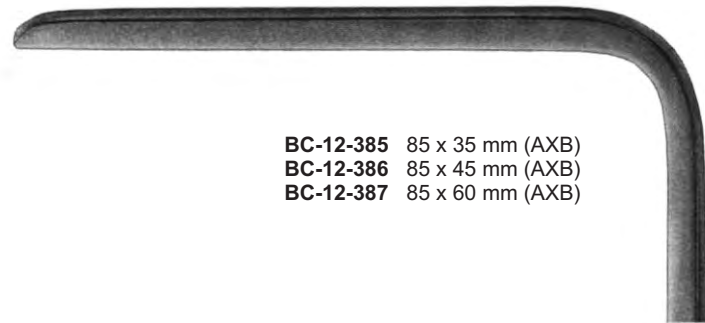

BC-12-385 85 x 35 mm (AXB)
BC-12-386 85 x 45 mm (AXB)
BC-12-387 85 x 60 mm (AXB)

1/1

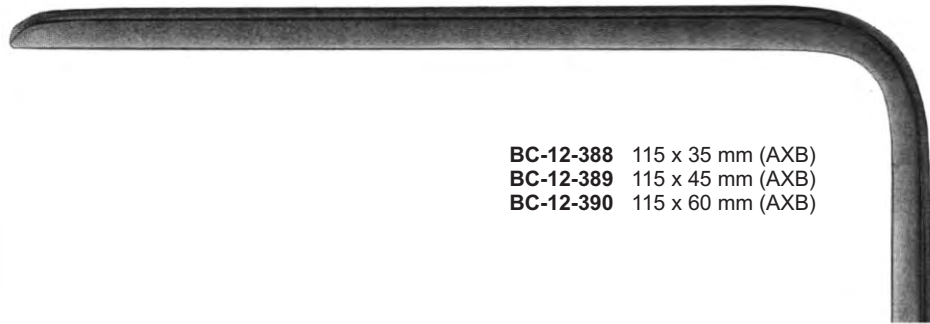

BC-12-388 115 x 35 mm (AXB)
BC-12-389 115 x 45 mm (AXB)
BC-12-390 115 x 60 mm (AXB)

1/1



1/2

Doyen
23 cm
Abdominal retractors
Separadores abdominales
Ecarteurs intra abdominaux



BC-12-391 160 x 45 mm (AXB)
BC-12-391-A 160 x 60 mm (AXB)

1/1

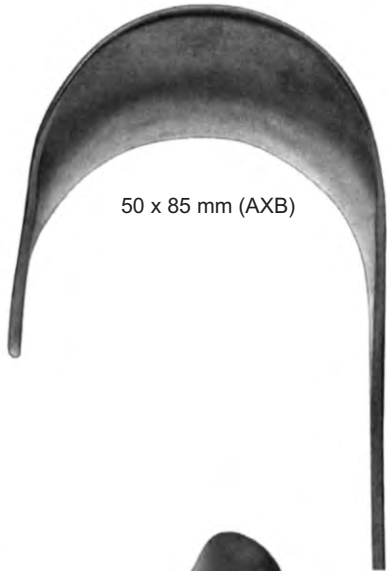

50 x 85 mm (AXB)



Doyen
BC-12-392
24 cm
Abdominal retractor
Separador abdominal
Ecarteur intra abdominaux

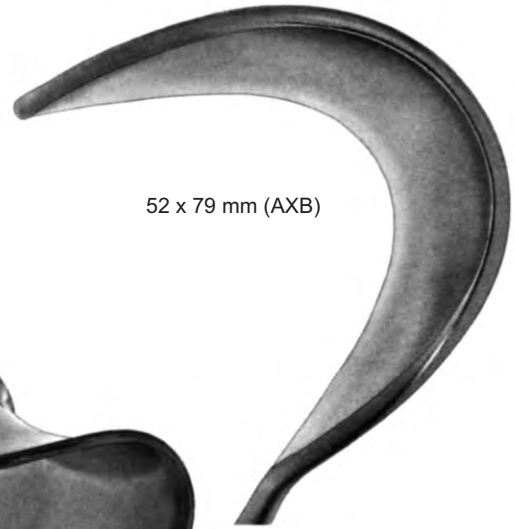

52 x 79 mm (AXB)



Mayo
BC-12-393
27.5 cm
Abdominal retractor
Separador abdominal
Ecarteur intra abdominaux



60 x 85 mm (AXB)

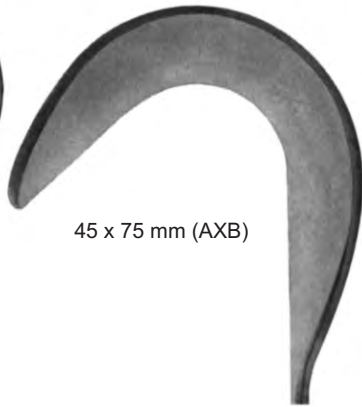

45 x 75 mm (AXB)

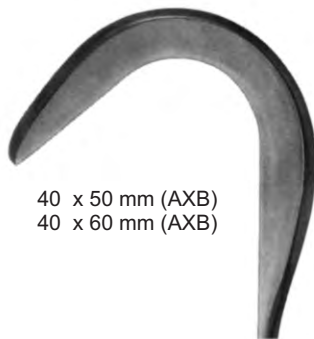

40 x 50 mm (AXB)
40 x 60 mm (AXB)



35 x 40 mm (AXB)



25 x 22 mm (AXB)

43 x 39 mm (AXB)

BC-12-399
25.5 cm

BC-12-400
27 cm

34 x 30 mm (AXB)

65 x 43 mm (AXB)



Richardson-Eastman
27 cm
Set. Juego. jue

Fritsch
BC-12-394 23.5 cm
BC-12-395 24.5 cm
BC-12-396 24.5 cm
BC-12-397 25.0 cm
BC-12-398 26.0 cm
handle vertical to the blade
mango vertical a la hoja
manche vertical a la valve



BC-12-401
50 x 19 mm (AXB)



BC-12-402
43 x 39 mm (AXB)



74 x 65 mm (AXB)



Richardson
24 cm



BC-12-403
32 x 30 mm (AXB)

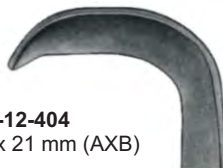

BC-12-404
25 x 21 mm (AXB)



Kelly
BC-12-405 23.5 cm / 9 1/4"
BC-12-406 24.0 cm / 9 1/2"
BC-12-407 25.0 cm / 10"

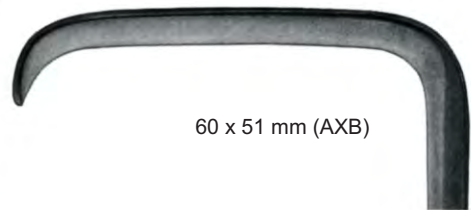

60 x 51 mm (AXB)

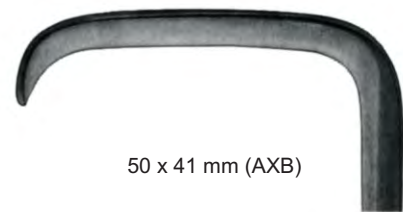

50 x 41 mm (AXB)

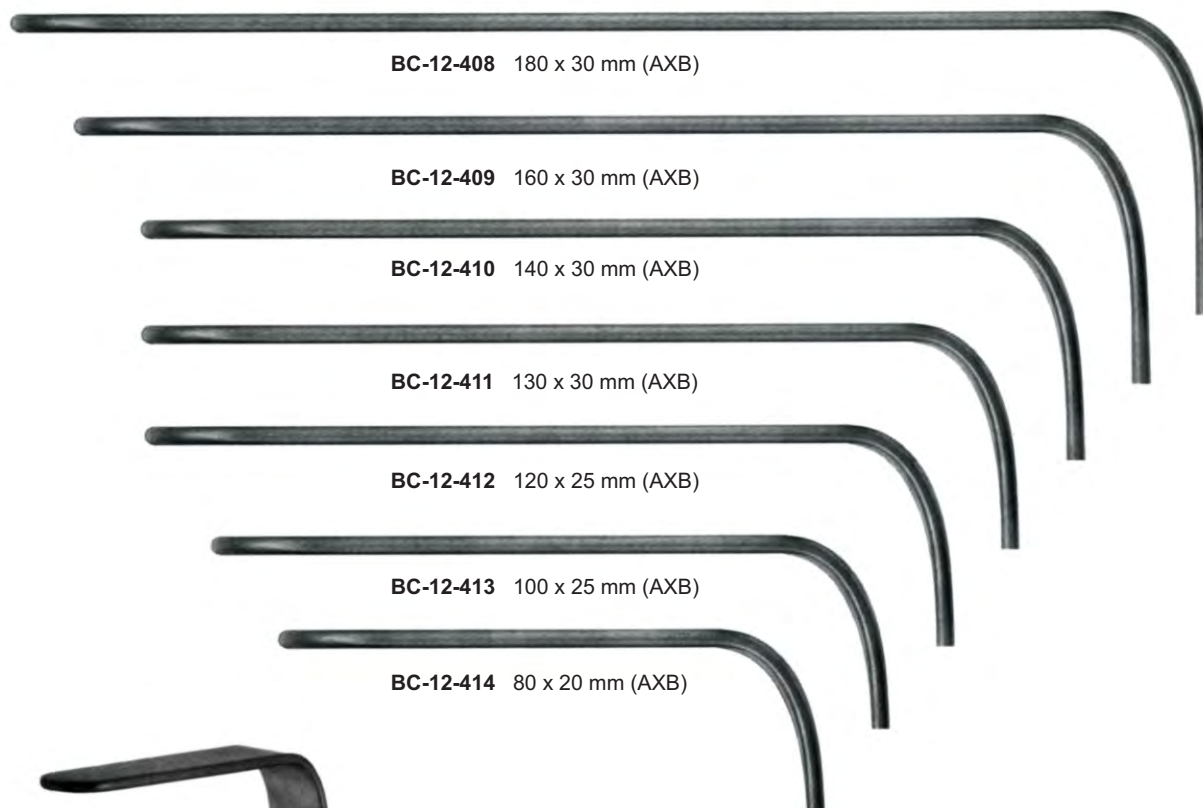

BC-12-408 180 x 30 mm (AXB)

BC-12-409 160 x 30 mm (AXB)

BC-12-410 140 x 30 mm (AXB)

BC-12-411 130 x 30 mm (AXB)

BC-12-412 120 x 25 mm (AXB)

BC-12-413 100 x 25 mm (AXB)

BC-12-414 80 x 20 mm (AXB)



Brunner
25 cm



Brunner
25 cm



BC-12-425 160 x 38 mm (AXB)

BC-12-426 160 x 57 mm (AXB)

BC-12-422 155 x 50 mm (AXB)

BC-12-423 125 x 50 mm (AXB)

BC-12-424 90 x 35 mm (AXB)

85 x 35 mm (AXB)

Kelly
27.5 cm

Mikulicz
BC-12-421
24.5 cm

Mikulicz
BC-12-422 25.0 cm / 10"
BC-12-423 26.0 cm / 10 1/4"
BC-12-424 26.5 cm / 10 1/2"
Liver retractors
Separadores para el higado
Ecarteurs pour foie



63 x 45 mm (AXB)

182 x 59 mm (AXB)

72 x 45 mm (AXB)

185 x 59 mm (AXB)

35 x 45 mm (AXB)

135 x 59 mm (AXB)

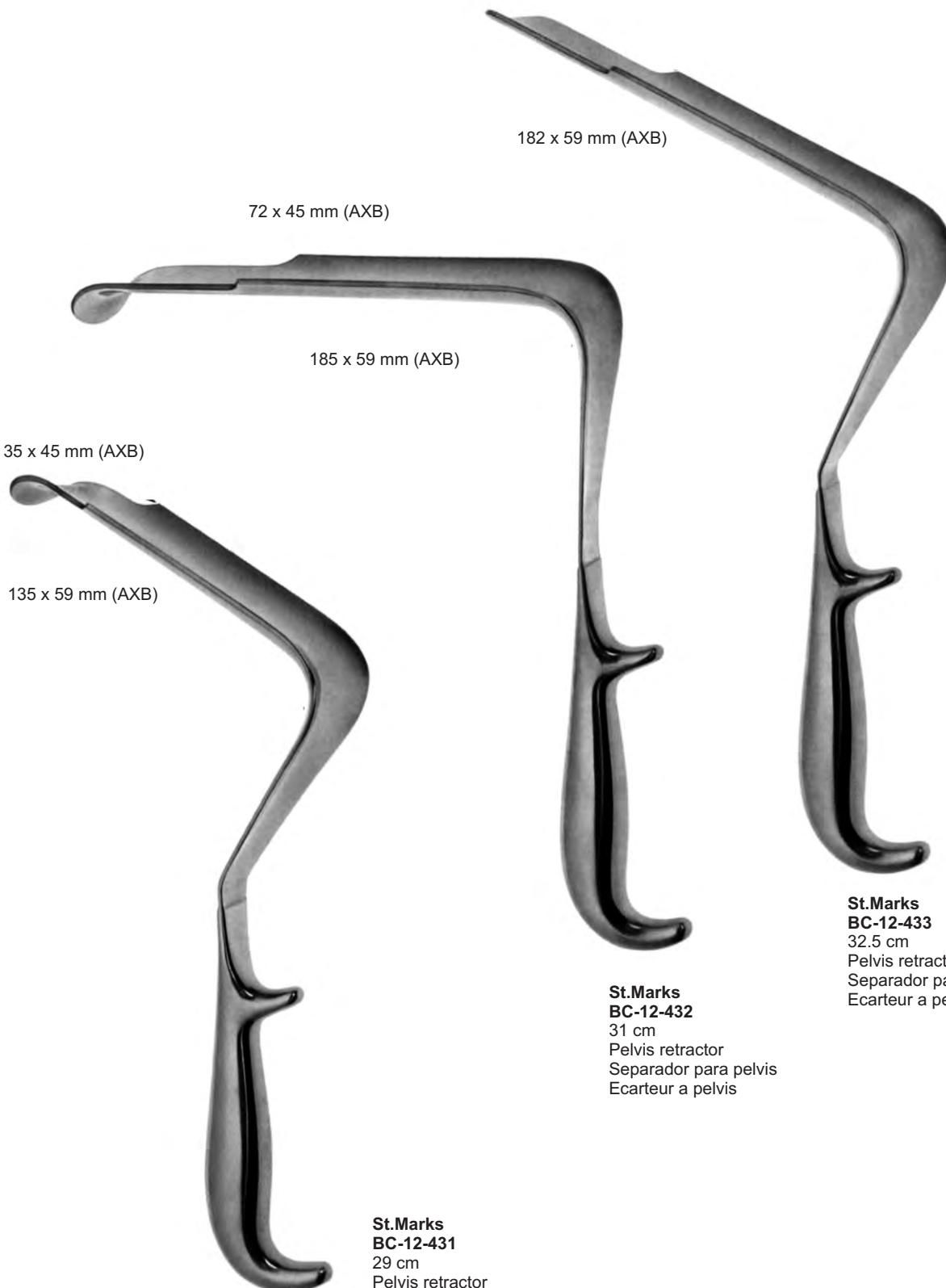

**St.Marks
BC-12-431**
29 cm
Pelvis retractor
Separador para pelvis
Ecarteur a pelvis

**St.Marks
BC-12-432**
31 cm
Pelvis retractor
Separador para pelvis
Ecarteur a pelvis

**St.Marks
BC-12-433**
32.5 cm
Pelvis retractor
Separador para pelvis
Ecarteur a pelvis





115 x 64 mm (AXB)



108 x 43 mm (AXB)

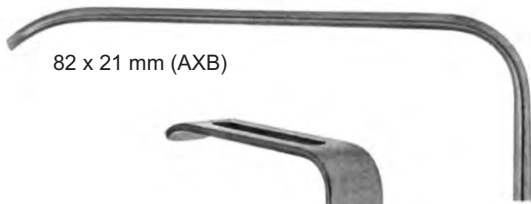

82 x 21 mm (AXB)



Coryllos
BC-12-440
24.5 cm



Coryllos
BC-12-439
24.5 cm



Coryllos
BC-12-438
24.5 cm



Davidson
BC-12-441
22 cm
Scapula retractor
Separador para scapula
Ecarteur a scapula



Davidson
BC-12-442
22 cm
Scapula retractor
Separador para scapula
Ecarteur a scapula



BC-12-443
18 mm



BC-12-444
24 mm



Semb
27.5 cm
Lung retractors
Separadores para el pulmon
Ecarteurs a poumons



Allison
BC-12-445
32.5 cm
Lung spatula
Separadores para el pulmon
Ecarteurs a poumons

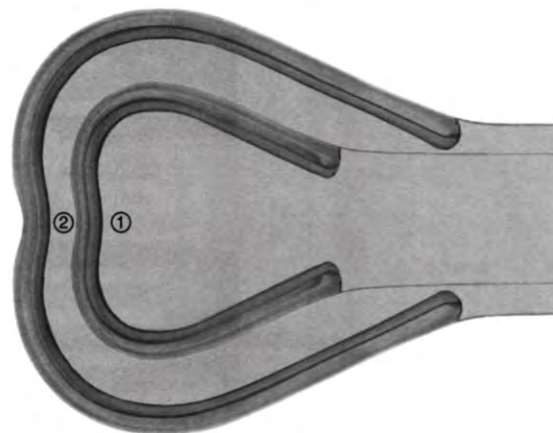
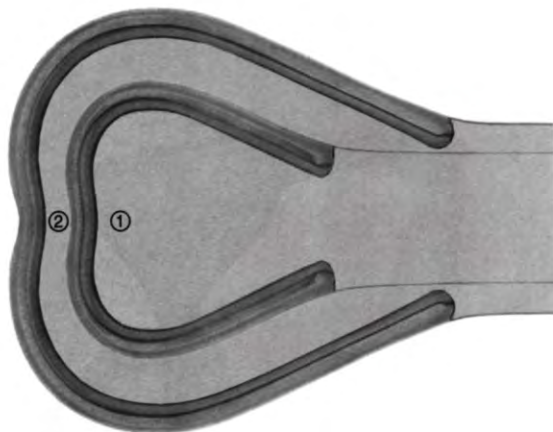

BC-12-446
150 x 41 mm (AXB)

BC-12-447
150 x 62 mm (AXB)

Harrington
32 cm / 12 1/2"



BC-12-448
150 x 41 mm (AXB)

BC-12-449
150 x 62 mm (AXB)

Harrington
33.5 cm

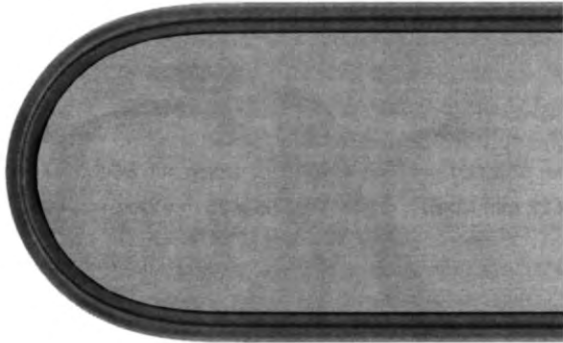

165 x 50 mm (AXB)



Foss
BC-12-450
36.5 cm



160 x 50 mm (AXB)

Ford-Deaver
BC-12-451
42 cm



111 x 25 mm (AXB)

**Deaver
BC-12-452**
23 cm



40 x 19 mm (AXB)

**Deaver
BC-12-453**
18 cm



55 x 22 mm (AXB)

**Deaver
BC-12-454**
22 cm



55 x 25 mm (AXB)

**Deaver
BC-12-455**
23 cm



100 x 25 mm (AXB)

**Deaver
BC-12-456**
30 cm



100 x 25 mm (AXB)

**Deaver
BC-12-457**
33 cm



100 x 25 mm (AXB)

**Deaver
BC-12-458**
36 cm

100 x 38 mm (AXB)



Deaver
BC-12-459
30 cm

100 x 50 mm (AXB)



Deaver
BC-12-460
30 cm

100 x 75 mm (AXB)



Deaver
BC-12-461
30.5 cm

100 x 25 mm (AXB)



Deaver
BC-12-462
30 cm

100 x 38 mm (AXB)



Deaver
BC-12-463
30 cm

100 x 50 mm (AXB)



Deaver
BC-12-464
30 cm

100 x 75 mm (AXB)



Deaver
BC-12-465
30 cm



105 x 35 mm (AXB)

Legueu
BC-12-466
27 cm



105 x 67 mm (AXB)

Kocher
BC-12-467
25 cm



BC-12-468
170 x 16 mm
malleable
maleable
malleable



BC-12-469
190 x 25 mm
malleable
maleable
malleable



BC-12-470 200 x 13 mm
BC-12-471 200 x 16 mm
malleable
maleable
malleable



BC-12-472 330 x 20 mm
BC-12-473 330 x 25 mm
BC-12-474 330 x 30 mm
BC-12-475 330 x 35 mm
BC-12-476 330 x 40 mm
BC-12-477 330 x 45 mm
BC-12-478 330 x 50 mm
malleable
maleable
malleable



Tuffier
BC-12-479
200 x 17/24 mm
malleable
maleable
malleable



Haberer
BC-12-480
300 x 40/50 mm
malleable
maleable
malleable



Reverdin
BC-12-481
280 x 41/65 mm



BC-12-482
40 mm

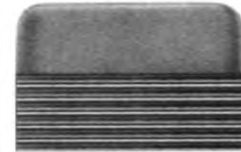

BC-12-483
30 mm



BC-12-484
20 mm



Kader
26.5 cm



Lacrymal Sac Retractors
 Separadores para saco lacrimal
 Ecarteurs pour le sac lacrymal



BC-13-101
7 cm



BC-13-102
4 cm



BC-13-103
7 cm



BC-13-104
3 cm

4 x 4 teeth
 4 x 4 dientes
 4 x 4 dents

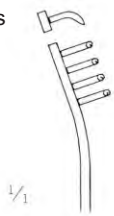

BC-13-105
7 cm
sharp
agudo
pointu



4 x 4



BC-13-106
10 cm
sharp
agudo
pointu



4 x 4



BC-13-107
7 cm
blunt
romo
mousse



4 x 4



BC-13-108
7 cm
blunt
romo
mousse



4 x 4



BC-13-109
sharp
agudo
pointu



BC-13-110
blunt
romo
mousse



Alm



Kaupp
(Holzheimer/Heiss)
10 cm



Jansen Gifford
BC-13-111
sharp
BC-13-112
blunt



Medicon
BC-13-113
11 cm

BC-13-115
center blade only



Shambaugh
BC-13-114
11 cm



William

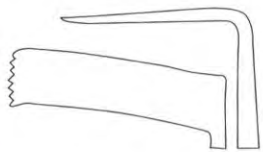

Williams
BC-13-116
1 cm / 5 cm

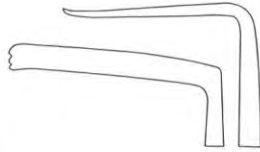

Williams
BC-13-117
1 cm / 7 cm

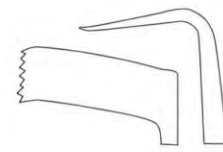

Williams
BC-13-118
2 cm / 5 cm

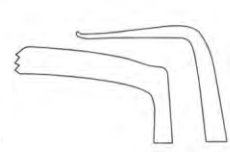

Williams
BC-13-119
2 cm / 7 cm

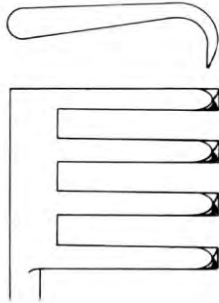

BC-13-120
 26 cm
 sharp
 agudo
 pointu

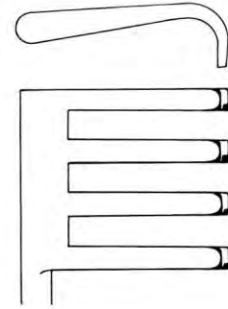

BC-13-121
 26 cm
 blunt
 romo
 mousse



Adson

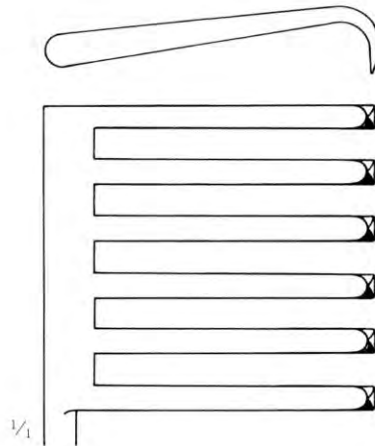

BC-13-120
 29 cm
 sharp
 agudo
 pointu

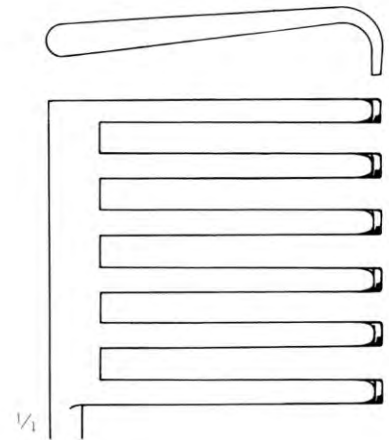

BC-13-123
 29 cm
 blunt
 romo
 mousse



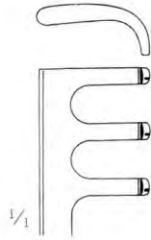

BC-13-124
10 cm
blunt
romo
mousse

Jansen
With adjusting screw
con tornillo de ajuste
avec vis d'ajustage

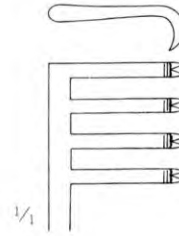

BC-13-125
13.5 cm
sharp
agudo
pointu

Scalp-Contour
With ratchet
con cremallera
avec cremaillere

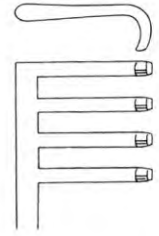

BC-13-126
13.5 cm
blunt
romo
mousse

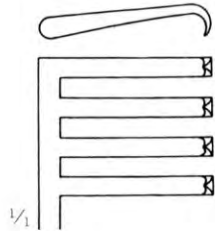

4:4
sharp
agudo
pointu

Anderson-Adson
BC-13-127
20 cm

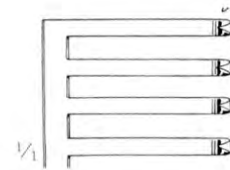

BC-13-128
3:4
sharp
agudo
pointu

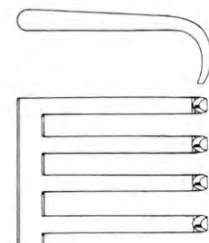

BC-13-129
3:4
blunt
romo
mousse

Weitlaner
20 cm



Weitlaner

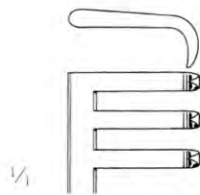

BC-13-130
11 cm

2 : 3
Sharp
agudo
pointu

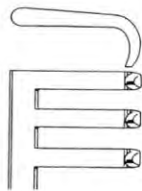

BC-13-131
11 cm

2 : 3
Blunt
romo
mousse



Weitlaner

3 : 4

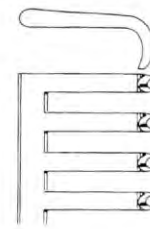

BC-13-132
13.5 cm
sharp
agudo
pointu

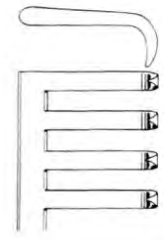

BC-13-133
16 cm
sharp
agudo
pointu

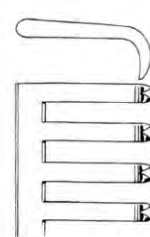

BC-13-134
13.5 cm
blunt
romo
mousse

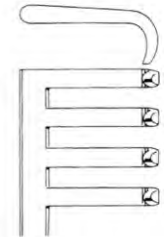

BC-13-135
16 cm
blunt
romo
mousse



Weitlaner-Wullstein

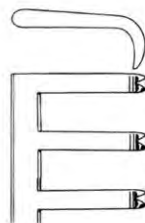

BC-13-136
13 cm
sharp
agudo
pointu

3 : 3

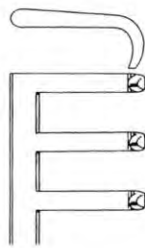

BC-13-137
13 cm
blunt
romo
mousse

3 : 3



Mollison

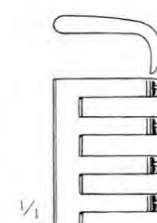

BC-13-138
15.5 cm
sharp
agudo
pointu

4 : 4

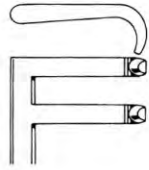

BC-13-139
13 cm
blunt
romo
mousse

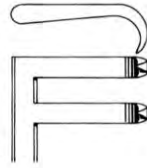

BC-13-140
13 cm
sharp
agudo
pointu



Plester

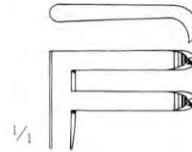

BC-13-141
10.5 cm
blunt
romo
mousse



Plester

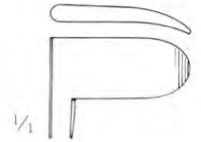

BC-13-142
10.5 cm
blunt
romo
mousse



Plester

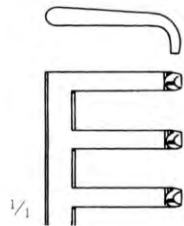

BC-13-143
13.5 cm
blunt
romo
mousse



Milligan

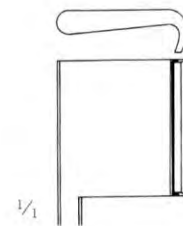

BC-13-142
13.5 cm



Weitlaner-Baby

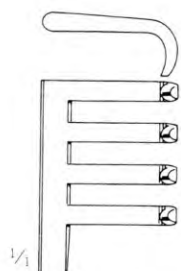

1/4

BC-13-145
 16 cm
 blunt
 romo
 mousse

3:4

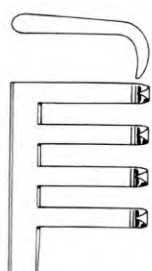

BC-13-146
 16 cm
 sharp
 agudo
 pointu

3:4

Central blades
 Valvas centrales
 Valvas centrales



Henley
 16 cm



BC-13-147



BC-13-148



BC-13-149

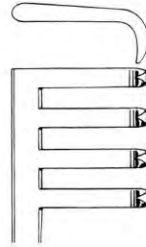

BC-13-150
13.5 cm

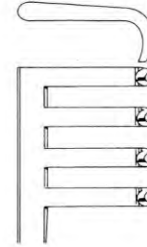

BC-13-151
13.5 cm

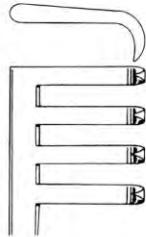

BC-13-152
16.5 cm

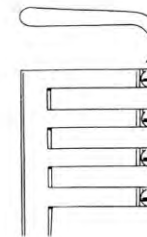

BC-13-153
16.5 cm

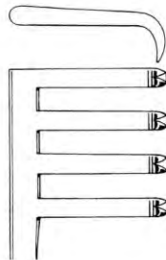

BC-13-154
21 cm

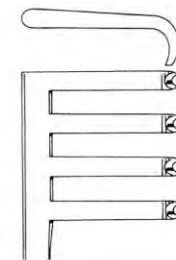

BC-13-155
21 cm

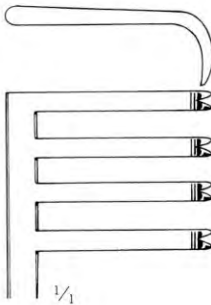

BC-13-156
24.5 cm
Sharp
agudo
pointu

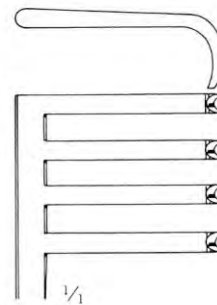

BC-13-157
24.5 cm
Blunt
romo
mousse



Adson



3 : 4



Cloward



BC-13-158
40 cm



BC-13-159
45 mm



BC-13-160
50 mm



BC-13-161
55 mm



BC-13-162
60 mm

BC-13-163
25 cm
Spreader only
Separador suelto
Ecarteur seul

BC-13-164
25 cm
Complete
completo
complet

With 2 each plug-in blades ref.
Con 2 valvas enchufables de c.u.ref.
Chacun avec deux valves
interchangeables ref.



BC-13-165
40 cm



BC-13-166
45 mm



BC-13-167
50 mm



BC-13-168
55 mm



BC-13-169
60 mm



Cloward

BC-13-170
15 cm
Spreader only
Separador suelto
Ecarteur seul

BC-13-171
15 cm
Complete
completo
complet

With 2 each plug-in blades ref.
Con 2 valvas enchufables de c.u.ref.
Chacun avec deux valves
interchangeables ref.



Beckman-Adson

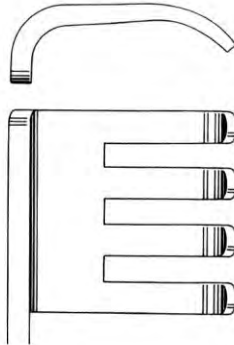

BC-13-172
 30.5 cm



Blunt
 romo
 mousse

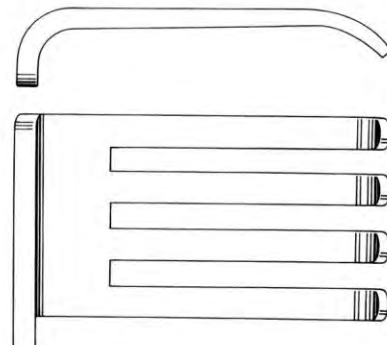

BC-13-173
 30.5 cm

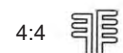

Blunt
 romo
 mousse

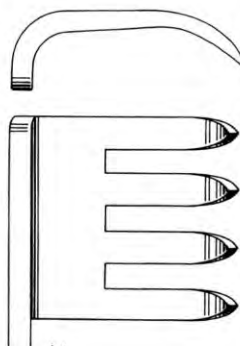

BC-13-174
 30.5 cm



sharp
 agudo
 pointu

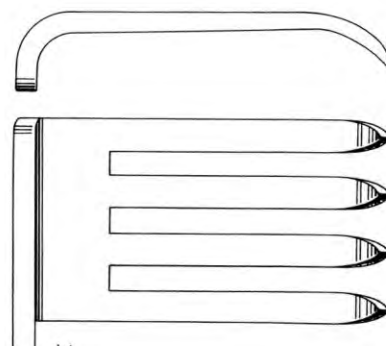

BC-13-175
 30.5 cm

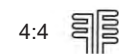

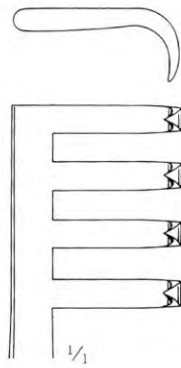

sharp
 agudo
 pointu

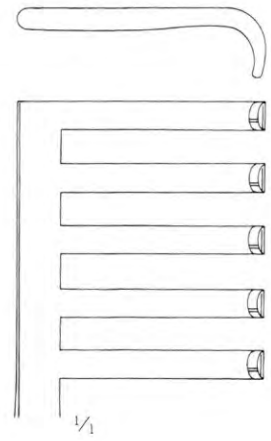

BC-13-176
32 cm
4:4 
sharp
agudo
pointu

Beckman



BC-13-177
33 cm
4:5 
Blunt
romo
mousse

Adson

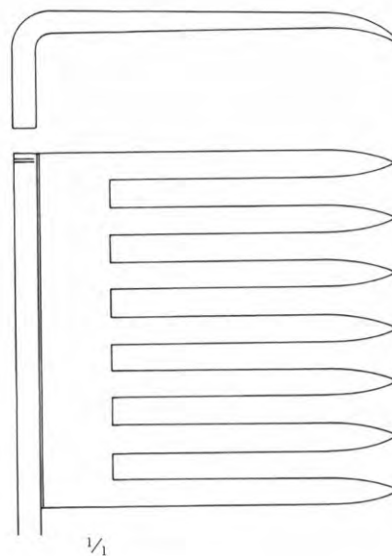

1/1

BC-13-178
32 cm

7:7 

sharp
agudo
pointu

Beckman-Eaton



Martin

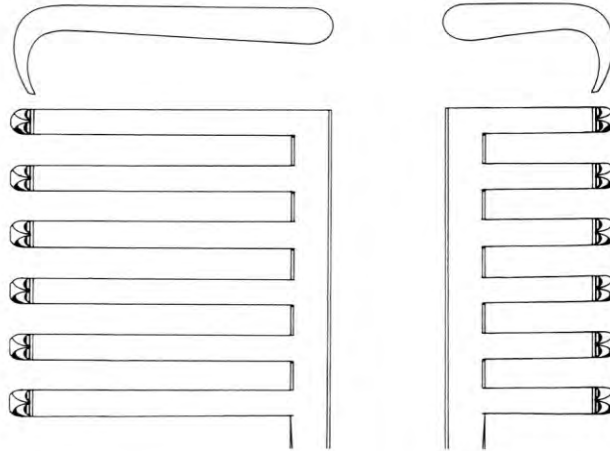

BC-13-179
28.5 cm

6:6 

sharp, long teeth on left side
agudo, garfios largos a la izquierda
pointu, griffes longues a gauche

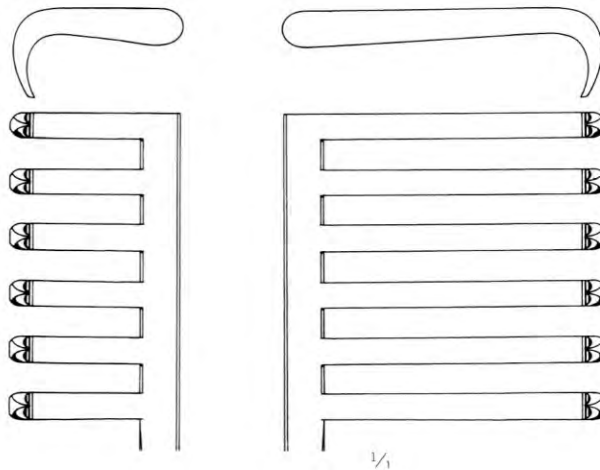

BC-13-180
28.5 cm

6:6 

sharp, long teeth on right side
agudo, dientes largos a la derecha
pointu, griffes longues a droite



BC-13-383
 29 x 80 mm
 Lateral blades only (Pair)

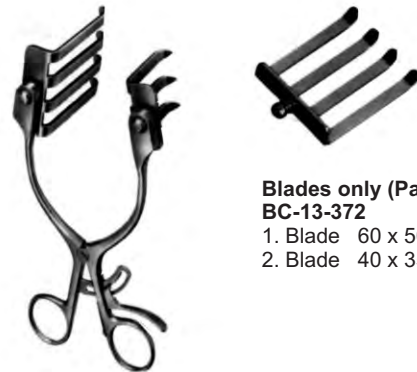

Blades only (Pair)
BC-13-372
 1. Blade 60 x 50 mm
 2. Blade 40 x 35 mm

Poplitea
BC-13-370 Retractor complete set
BC-13-371 Retractor only
BC-13-372 Blades (Pair)

Holzbach
BC-13-380 Complete set
BC-13-381 Spreader only
BC-13-382 Center Blades 74 x 82 mm
BC-13-383 Lateral blades 59 x 80 mm



sharp agudo pointu



blunt romo mousse



Jansen
BC-13-190
 10 cm / 4"



Jansen
BC-13-191
 10 cm / 4"



Joll
BC-13-192
15.5 cm
Thyroid and vaginal retractor
Separador para tiroides y vagina
Ecarteur pour thyroide et vulva

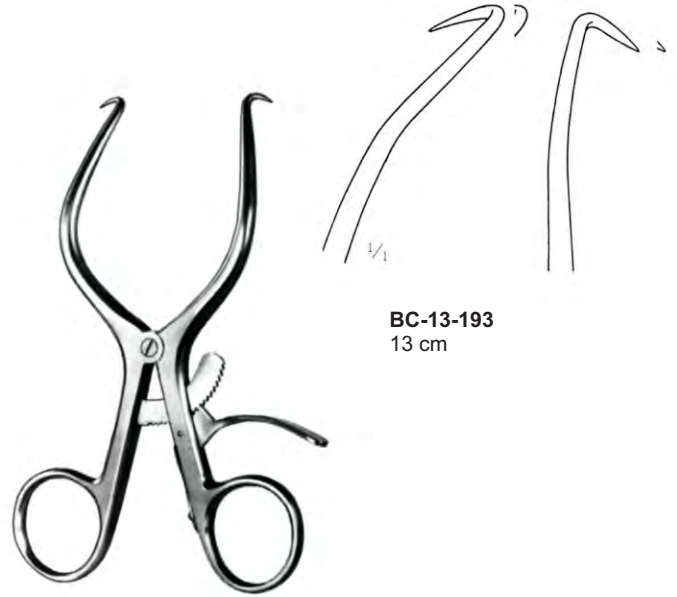

BC-13-193
13 cm

Gelpi

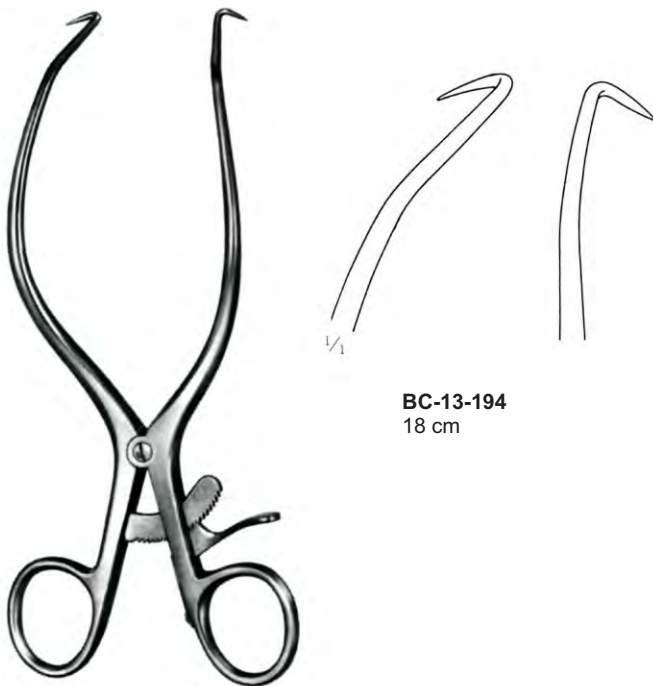

BC-13-194
18 cm

Gelpi

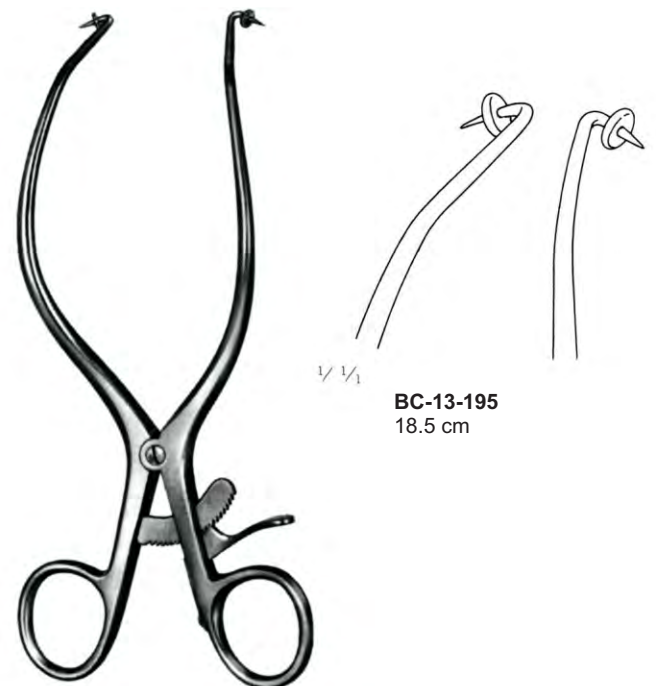

BC-13-195
18.5 cm

Gelpi



Ricard
BC-13-196A

BC-13-196
Central blade
Valva central
Valva central
55 x 70 mm



BC-13-198
Piece
Pieza
Piece

BC-13-197
Central blade
Valva central
Valva central
80 x 90 mm



BC-13-199
Piece
Pieza
Piece



Collin, Baby
BC-13-200
20 cm



BC-13-201 **BC-13-202**



Walton
BC-13-203
18 cm right
BC-13-204
18 cm left



Collin
BC-13-207
24 cm



Knighton
BC-13-205
19 cm right
BC-13-206
19 cm left



Collin
BC-13-208
22.5 cm



Collin
BC-13-209
31 cm

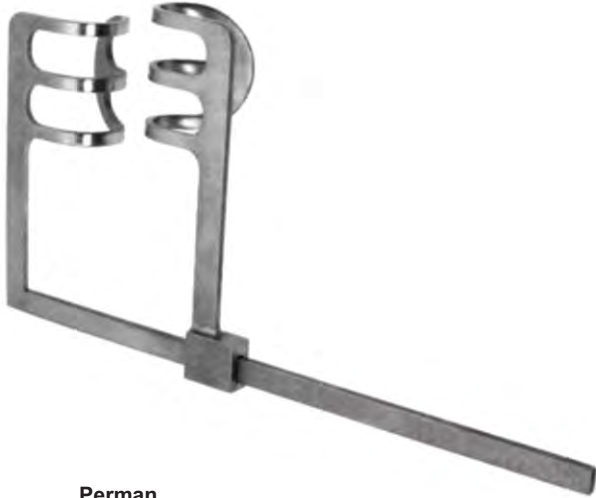

Perman
BC-13-210
Abdominal retractor, Lateral valves
60 x 60 mm (AxB)

Separador abdominal, valvas Laterales
60 x 60 mm (AxB)

Ecarteur abdominal, valvas Laterales
60 x 60 mm (AxB)

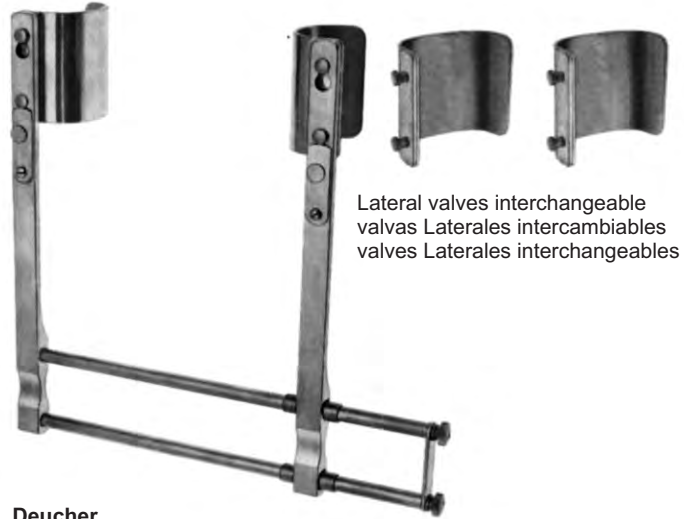

Deucher
BC-13-211
Abdominal retractor, complete, consisting of:
BC-13-212 1 Frame
BC-13-213 1 Pair lateral valves 52 x 60 mm (AxB)
BC-13-214 1 Pair lateral valves 64 x 60 mm (AxB)

Separador abdominal, completo, compuesto de:

- BC-13-212** 1 Cuadro
- BC-13-213** 1 Par de valvas laterales 52 x 60 mm (AxB)
- BC-13-214** 1 Par de valvas laterales 64 x 60 mm (AxB)

Ecarteur abdominaux, complet, compose de:

- BC-13-212** 1 Cadre
- BC-13-213** 1 Paire de valvas laterales 52 x 60 mm (AxB)
- BC-13-214** 1 Paire de valvas laterales 64 x 60 mm (AxB)

Lateral valves interchangeable
valvas Laterales intercambiables
valves Laterales interchangeables



Gosset-Baby
BC-13-215
Abdominal retractor, lateral valves
38 x 23 mm (AxB) & 38 x 31 mm (AxB)

Separador abdominal, valvas laterales
38 x 23 mm (AxB) y 38 x 31 mm (AxB)

Ecarteur abdominal, valvas laterales
38 x 23 mm (AxB) et 38 x 31 mm (AxB)



Gosset
BC-13-216
Abdominal retractor, lateral valves
63 x 29 mm (AxB) and 63 x 36 mm (AxB)

Separador abdominal, valvas laterales
63 x 29 mm (AxB) y 63 x 36 mm (AxB)

Ecarteur abdominal, valvas Laterales
63 x 29 mm (AxB) et 63 x 36 mm (AxB)



**Gosset
 BC-13-217**

Abdominal retractor, Lateral valves 63 x 29 mm (AxB) & 63 x 36 mm (AxB), with central valve 59 x 57 mm

Separador abdominal, valvas Laterales 63 x 29 mm (AxB) y 63 x 36 mm (AxB), con valva central 59 x 57 mm

Ecarteur abdominal, valves Laterales 63 x 29 mm (AxB) et 63 x 36 mm (AxB), avec valve centrale 59 x 57 mm



**Balfour-Baby
 BC-13-218**

Abdominal retractor, Lateral valves 27 x 23 mm (AxB) & 27 x 28 mm (AxB), with central valve 22 x 24 mm

Separador abdominal, valvas Laterales 27 x 23 mm (AxB) 27 x 28 mm (AxB), con valva central 22 x 24 mm

Ecarteur abdominal, valves Laterales 27 x 23 mm (AxB) et 27 x 28 mm (AxB), avec valve centrale 22 x 24 mm



**Balfour
 BC-13-219**

Abdominal retractor, Lateral valves 48 x 28 mm (AxB) & 48 x 39 mm (AxB), with central valve 48 x 78 mm

Separador abdominal, valvas Laterales 48 x 28 mm (AxB) y 48 x 39 mm (AxB), con valva central 48 x 78 mm

Ecarteur abdominal, valves Laterales 48 x 28 mm (AxB) et 48 x 39 mm (AxB), avec valve centrale 48 x 78 mm



**Balfour
 BC-13-220**

Abdominal retractor, Lateral valves 60 x 32 mm (AxB) & 60 x 38 mm (AxB), with central valve 48 x 78 mm

Separador abdominal, valvas Laterales 60 x 32 mm (AxB) y 60 x 38 mm (AxB), con valva central 48 x 78 mm

Ecarteur abdominal, valves Laterales 60 x 32 mm (AxB) et 60 x 38 mm (AxB), avec valve centrale 48 x 78 mm

250 mm



**Balfour
BC-13-221**

Abdominal retractor, Lateral valves 100 x 32 mm (AxB) & 100 x 38 mm (AxB), with central valve 80 x 80 mm (**BC-13-207**)

Separador abdominal, valvas Laterales 100 x 32 mm (AxB) y 100 x 38 mm (AxB), con valve central 80 x 80 mm (**BC-13-207**)

Ecarteur abdominal, valves Laterales 100 x 32 mm (AxB) et 100 x 38 mm (AxB), avec valve central 80 x 80 mm (**BC-21-207**)

180 mm



**Balfour
BC-13-222**

Abdominal retractor, Lateral valves 60 x 36 mm (AxB) with central valve 48 x 78 mm (**BC-13-209**)

Separador abdominal, valvas Laterales 60 x 36 mm (AxB) con valve central 48 x 78 mm (**BC-13-209**)

Ecarteur abdominal, valves Laterales 60 x 36 mm (AxB) avec valve centrale 48 x 78 mm (**BC-13-209**)

250 mm

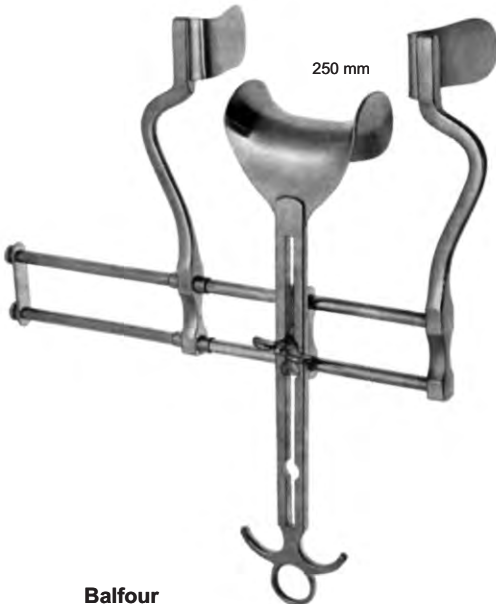

**Balfour
BC-13-223**

Abdominal retractor, Lateral valves 60 x 36 mm (AxB) with central valve 48 x 78 mm (**BC-13-211**)

Separador abdominal, valvas Laterales 60 x 36 mm (AxB) con valve central 48 x 78 mm (**BC-13-211**)

Ecarteur abdominal, valves Laterales 60 x 36 mm (AxB) avec valve centrale 48 x 78 mm (**BC-13-211**)

180 mm



**Balfour
BC-13-224**

Abdominal retractor, Lateral valves 100 x 32 mm (AxB) & 100 x 38 mm (AxB), with central valve 100 x 64 mm (**BC-13-213**)

Separador abdominal, valvas Laterales 100 x 32 mm (AxB) y 100 x 38 mm (AxB), con valve central 100 x 64 mm (**BC-13-213**)

Ecarteur abdominal, valves Laterales 100 x 32 mm (AxB) et 100 x 38 mm (AxB), avec valve central 100 x 64 mm (**BC-21-213**)

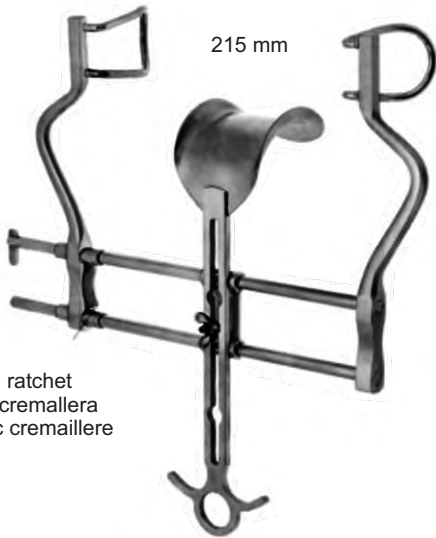

215 mm

With ratchet
con cremallera
avec cremaillere

Balfour modif.

BC-13-225

Abdominal retractor, Lateral valves 64 x 45 mm (AxB)
with central valve 70 x 66 mm (**BC-13-225-A**)

Separador abdominal, valvas Laterales 64 x 45 mm (AxB)
con valve central 70 x 66 mm(**BC-13-225-A**)

Ecarteur abdominal, valves Laterales 64 x 45 mm (AxB)
avec valve centrale 70 x 66 mm (**BC-13-225-A**)

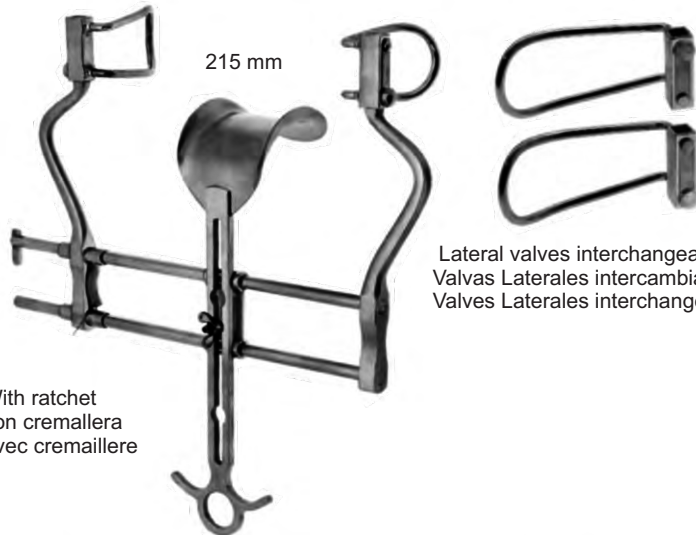

215 mm

With ratchet
con cremallera
avec cremaillere

Lateral valves interchangeable
Valvas Laterales intercambiables
Valves Laterales interchangeables

Balfour modif.

BC-13-226

Abdominal retractor, complete, consisting of:

- BC-13-227** 1 Frame
- BC-13-228** 1 Pair lateral valves 64 x 45 mm (AxB)
- BC-13-229** 1 Pair lateral valves 89 x 45 mm (AxB)
- BC-13-230** 1 Central valves 70 x 66 mm (AxB)

Separador abdominal, completo, compuesto de:

- BC-13-227** 1 Cuadro
- BC-13-228** 1 Par de valvas laterales 64 x 45 mm (AxB)
- BC-13-229** 1 Par de valvas laterales 89 x 45 mm (AxB)
- BC-13-230** 1 Valve Central 70 x 66 mm (AxB)

Ecarteur abdominal, complet, compose de:

- BC-13-227** 1 Cadre
- BC-13-228** 1 Paire de valvas laterales 64 x 45 mm (AxB)
- BC-13-229** 1 Paire de valvas laterales 89 x 45 mm (AxB)
- BC-13-230** 1 valve Centrale 70 x 66 mm (AxB)

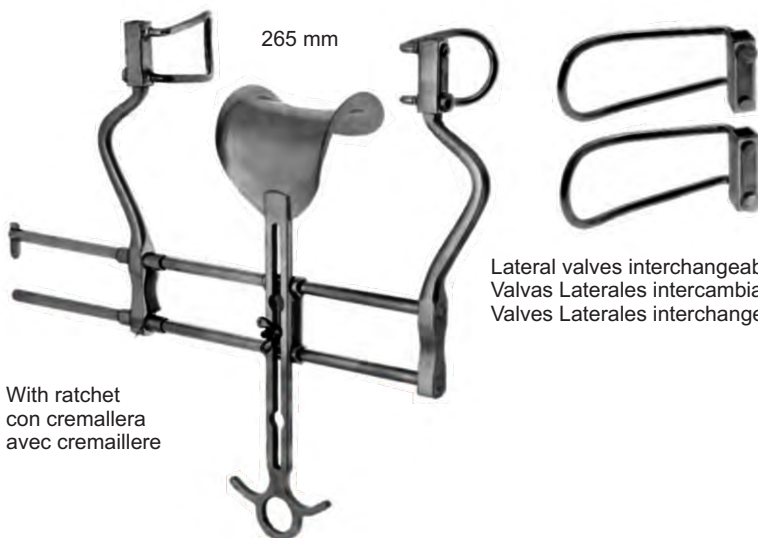

265 mm

With ratchet
con cremallera
avec cremaillere

Lateral valves interchangeable
Valvas Laterales intercambiables
Valves Laterales interchangeables

Balfour modif.

BC-21-231

Abdominal retractor, complete, consisting of:

- BC-13-232** 1 Frame
- BC-13-233** 1 Pair lateral valves 64 x 45 mm (AxB)
- BC-13-234** 1 Pair lateral valves 89 x 45 mm (AxB)
- BC-13-235** 1 Central valves 65 x 84 mm (AxB)

Separador abdominal, completo, compuesto de:

- BC-13-232** 1 Cuadro
- BC-13-233** 1 Par de valvas laterales 64 x 45 mm (AxB)
- BC-13-234** 1 Par de valvas laterales 89 x 45 mm (AxB)
- BC-13-235** 1 Valves Central 65 x 84 mm (AxB)

Ecarteur abdominal, complet, compose de:

- BC-13-232** 1 Cadre
- BC-13-233** 1 Pair de valvas laterales 64 x 45 mm (AxB)
- BC-13-234** 1 Paire de valvas laterales 89 x 45 mm (AxB)
- BC-13-235** 1 valvas Centrale 65 x 84 mm (AxB)



Balfour

BC-13-236 64 x 45 mm (AxB)
BC-13-237 89 x 45 mm (AxB)
BC-13-238 103 x 45 mm (AxB)

lateral valves, 1 pair, for abdominal retractors
BC-13-225 / BC-13-226 / BC-13-231

valves laterales, 1 par, para Separadores abdominales **BC-13-225 / BC-13-226 / BC-13-231**

valves laterales, 1 paire, pour ecarteurs abdominaux **BC-13-225 / BC-13-226 / BC-13-231**



Balfour

BC-13-239 70 x 66 mm (AxB)
BC-13-240 65 x 84 mm (AxB)
BC-13-241 45 x 93 mm (AxB)

Central valves for abdominal retractors
BC-13-225 / BC-13-226 / BC-13-231

valves centrales, para Separadores abdominales **BC-13-225 / BC-13-226 / BC-13-231**

valves centrales, pour ecarteurs abdominaux **BC-13-225 / BC-13-226 / BC-13-231**



Horgan

BC-13-242
183 x 51 mm (AxB)

Central valves, malleable, for abdominal retractors **BC-13-225 / BC-13-226 / BC-13-231**

valves centrales, maleable, para separadores abdominales **BC-13-225 / BC-13-226 / BC-13-231**

valve centrale, malleable, pour ecarteurs abdominaux **BC-13-225 / BC-13-226 / BC-13-231**



Balfour

BC-13-243 right derecho a droite
BC-13-244 left, izquierdo, a gauche

Side-arms for abdominal retractors
Brazos laterales para Separadores abdominales
Bras lateraux pour ecarteurs abdominaux



O' Sullivan-O'Connor
BC-13-245

Abdominal retractor, complete, consisting of:

- BC-13-246** 1 Frame with 2 lateral valves 62 x 25 mm (AxB)
- BC-13-247** 2 valves 81 x 46 mm (AxB)
- BC-13-248** 1 valve 110 x 72 mm (AxB)

Separador abdominal, completo, compuesto de:

- BC-13-246** 1 Cuadro con 2 valvas laterales 62 x 25 mm (AxB)
- BC-13-247** 2 valvas 81 x 46 mm (AxB)
- BC-13-248** 1 valva 110 x 72 mm (AxB)

Ecarteur abdominal, complet, compose de:

- BC-13-246** 1 Cadre avec 2 valvas laterales 62 x 25 mm (AxB)
- BC-13-247** 2 valvas 81 x 46 mm (AxB)
- BC-13-248** 1 valva 110 x 72 mm (AxB)

Franz
BC-13-249

Abdominal retractor, complete, consisting of:

- BC-13-250** 1 Folding frame 220 x 220 mm
- BC-13-251** 2 valves 40 x 62 mm (AxB)
- BC-13-252** 2 valves 43 x 80 mm (AxB)
- BC-13-253** 2 valves 48 x 65 mm (AxB)
- BC-13-254** 2 valves 46 x 91 mm (AxB)

Separador abdominal, completo, compuesto de:

- BC-13-250** 1 Cuadro plegable 220 x 220 mm
- BC-13-251** 2 valvas 40 x 62 mm (AxB)
- BC-13-252** 2 valvas 43 x 80 mm (AxB)
- BC-13-253** 2 valvas 48 x 65 mm (AxB)
- BC-13-254** 2 valvas 46 x 91 mm (AxB)

Ecarteur abdominal, complet, compose de:

- BC-13-250** 1 Cadre pliant 220 x 220 mm
- BC-13-251** 2 valvas 40 x 62 mm (AxB)
- BC-13-252** 2 valvas 43 x 80 mm (AxB)
- BC-13-253** 2 valvas 48 x 65 mm (AxB)
- BC-13-254** 2 valvas 46 x 91 mm (AxB)

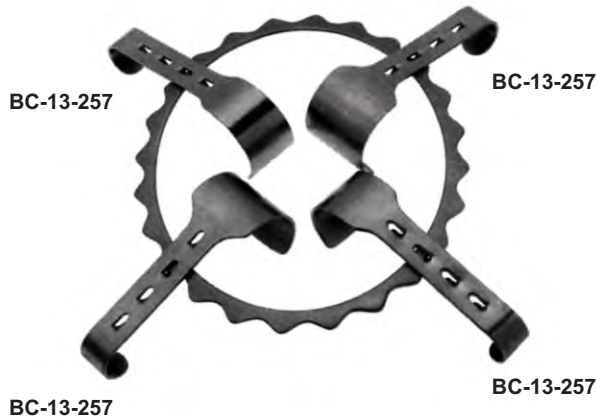

**Denis-Browne
BC-13-255**

Abdominal retractor, complete, consisting of:
BC-13-256 1 Frame 180 x 150 mm
BC-13-257 2 Valves 40 x 30 mm (AxB)
BC-13-258 2 Valves 40 x 40 mm (AxB)

Separador abdominal, completo, compuesto de:
BC-13-256 1 Cuadro 180 x 150 mm
BC-13-257 2 Valvas 40 x 30 mm (AxB)
BC-13-258 2 Valvas 40 x 40 mm (AxB)

Ecarteur abdominal, complet, compose de:
BC-13-256 1 Cadre 180 x 150 mm
BC-13-257 2 Valves 40 x 62 mm (AxB)
BC-13-258 2 Valves 40 x 80 mm (AxB)

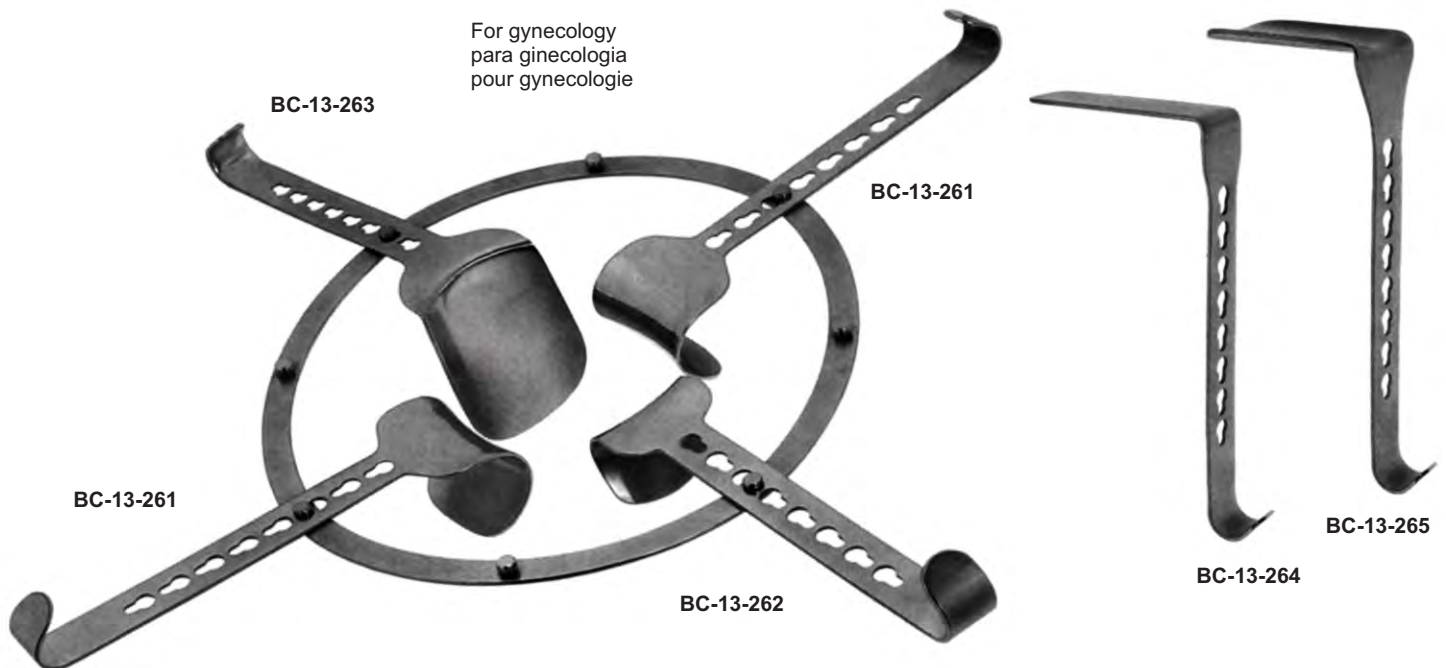

**Semm
BC-13-259**

Abdominal retractor, complete, consisting of:
BC-13-260 1 Frame 275 x 250 mm
BC-13-261 2 Valves 47 x 65 mm (AxB)
BC-13-262 1 Valve for bladder 50 x 54 mm (AxB)
BC-13-263 1 Valve for intestine 76 x 98 mm
BC-13-264 1 Valve for intestine 98 x 52 mm (AxB)
BC-13-265 1 Valve 105 x 35 mm (AxB)

Separadores abdominal, complet, compuesto de:
BC-13-260 1 Cadre 275 x 250 mm
BC-13-261 2 Valves 47 x 65 mm (AxB)
BC-13-262 1 Valva para vejiga 50 x 54 mm (AxB)
BC-13-263 1 Valva para intestino 76 x 98 mm
BC-13-264 1 Valva para intestino 98 x 52 mm (AxB)
BC-13-265 1 Valva 105 x 35 mm (AxB)

Ecarteur abdominal, complet, compose de:
BC-13-260 1 Cadre 275 x 250 mm
BC-13-261 2 Valves 47 x 65 mm (AxB)
BC-13-262 1 Valve pour vessie 50 x 54 mm (AxB)
BC-13-263 1 Valve pour intestin 76 x 98 mm
BC-13-264 1 Valve pour intestin 98 x 52 mm (AxB)
BC-13-265 1 Valve 105 x 35 mm (AxB)

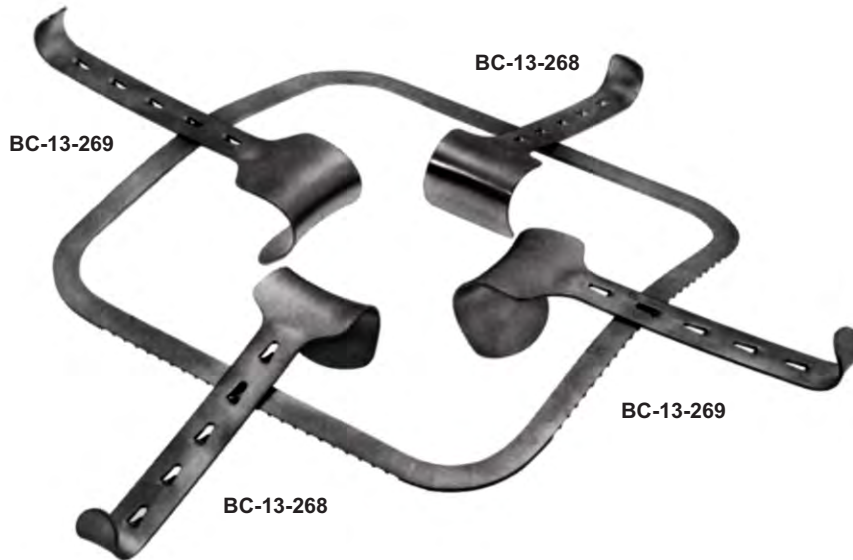

**Kirschner
 BC-13-266**

Abdominal retractor, complete, consisting of:

- BC-13-267** 1 Fixed Frame 250 x 250 mm
- BC-13-268** 2 Valves 43 x 55 mm (AxB)
- BC-13-269** 2 Valves 48 x 65 mm (AxB)

Separador abdominal, completo, compuesto de:

- BC-13-267** 1 Cuadro fijo 250 x 250 mm
- BC-13-268** 2 Valvas 43 x 55 mm (AxB)
- BC-13-269** 2 Valvas 48 x 65 mm (AxB)

Ecarteur abdominal, complet, compose de:

- BC-13-267** 1 Cadre fixe 250 x 250 mm
- BC-13-268** 2 Valves 43 x 55 mm (AxB)
- BC-13-269** 2 Valves 48 x 65 mm (AxB)



**Kirschner
 BC-13-270**

Abdominal retractor, complete, consisting of:

- BC-13-271** 1 Folding Frame 255 x 255 mm
- BC-13-272** 2 Valves 43 x 55 mm (AxB)
- BC-13-273** 2 Valves 48 x 65 mm (AxB)

Separador abdominal, completo, compuesto de:

- BC-13-271** 1 Cuadro plegable 255 x 255 mm
- BC-13-272** 2 Valvas 43 x 55 mm (AxB)
- BC-13-273** 2 Valvas 48 x 65 mm (AxB)

Ecarteur abdominal, complet, compose de:

- BC-13-271** 1 Cadre pliant 255 x 255 mm
- BC-13-272** 2 Valves 43 x 55 mm (AxB)
- BC-13-273** 2 Valves 48 x 65 mm (AxB)



Kirschner
BC-13-274 43 x 55 mm (AxB)
BC-13-275 48 x 65 mm (AxB)
BC-13-276 80 x 90 mm (AxB)
BC-13-277 90 x 65 mm (AxB)
BC-13-278 98 x 95 mm (AxB)



Kirschner-Balfour
BC-13-279
83 x 82 mm (AxB)



Kirschner
BC-13-280
60 x 82 mm (AxB)



Kirschner
BC-13-281 98 x 51 mm (AxB)
BC-13-282 105 x 38 mm (AxB)



**Foerster
 BC-13-283**

Abdominal retractor, made of NYLON, Transparent to X-ray, sterilizable only in the autoclave at 2 bar over-pressure (134°C), complete, consisting of:

BC-13-284 1 Frame 255 x 255 mm

BC-13-285 4 Valves 51 x 64 mm (AxB)

Separador abdominal , de NILON, transparente a los rayos-x, esterilizable solamente en autoclave a 2 bar sobresion (134°C), completo, compuesto de:

BC-13-284 1 Cuadro 255 x 255 mm

BC-13-285 4 Valvas 51 x 64 mm (AxB)

Ecarteur abdominal , en VINYL, transparent aux rayons X sterilisable en autoclave a 2 bar (134°C) seulement, complet, compose de:

BC-13-284 1 Cadr 255 x 255 mm

BC-13-285 4 Valves 51 x 64 mm (AxB)



**Foerster
 BC-13-285**

51 x 64 mm (AxB)

Valve, made of NYLON, for Abdominal retractor, (BC-13-283)

Valva, de NILON, para separador Abdominal (BC-13-283)

Valve, VINYL, para ecarteur Abdominal (BC-13-283)



**Foerster
 BC-13-286**

78 x 65 mm (AxB)

Valve, made of NYLON, for Abdominal retractor, (BC-13-283)

Valva, de NILON, para separador Abdominal (BC-13-283)

Valve, VINYL, para ecarteur Abdominal (BC-13-283)



**Foerster
 BC-13-287**

Spare button, made of NYLON, for fro frame, (BC-13-283)

Boton de repuesto, de NILON para cuadro (BC-13-283)

Bouton VINYL, pour cadre (BC-13-283)



Rochard
BC-13-288 50 x 90 (AxB)
BC-13-289 50 x 105 (AxB)
BC-13-290 50 x 120 (AxB)
BC-13-291 50 x 135 (AxB)
BC-13-292 50 x 155 (AxB)
 29 cm
 Abdominal retractors
 Separadores abdominales
 Ecarteur abdominal



Rochard
BC-13-293
 19.5 cm
 Fixation device for 20-1015 - 20-1019
 Dispositivo de fijacion para 20-1015 - 20-1019
 Compas articule pour 20-1015 - 20-1019



Doyen
BC-13-294



Doyen
BC-13-295 95 x 60 (AxB)
BC-13-296 105 x 65 (AxB)
BC-13-297 115 x 65 (AxB)
BC-13-298 125 x 65 (AxB)
 28 cm



Millin

BC-13-299

21.5 cm

Bladder retractor, complete, consisting of:

- BC-13-300** 1 Spreader
- BC-13-301** 1 Pair lateral Valves 57 x 25 mm (AxB)
- BC-13-302** 1 Pair lateral Valves 80 x 25 mm (AxB)
- BC-13-303** 1 Central Valve 120 x 45 mm (AxB)

Separador para la vejiga , completo, compuesto de:

- BC-13-300** 1 Separador
- BC-13-301** 1 Par de Valvas laterales 57 x 25 mm (AxB)
- BC-13-302** 1 Par de Valvas laterales 80 x 25 mm (AxB)
- BC-13-303** 1 Valve central 120 x 45 mm (AxB)

Ecarteur vesical, complet, compose de:

- BC-13-300** 1 Ecarteur
- BC-13-301** 1 Pair de Valvas laterales 57 x 25 mm (AxB)
- BC-13-302** 1 Pair de Valvas laterales 80 x 25 mm (AxB)
- BC-13-303** 1 Valve central 120 x 25 mm (AxB)



Judd-Masson

BC-13-304

Bladder & suprapubic retractor, complete, consisting of:

- BC-13-305** 1 Frame with 2 valves 70 x 25 mm(AxB)
- BC-13-306** 1 Central valve 84 x 24 mm (AxB)

Separador para la vejiga y la prostatectomia suprapubica , completo, compuesto de:

- BC-13-305** 1 Cuadro con 2 valvas laterales 70 x 25 mm(AxB)
- BC-13-306** 1 Central valve 84 x 24 mm (AxB)

Ecarteur pour la vessie et prostatectomie, complet, compose de:

- BC-13-305** 1 Cadre avec 2 valvas laterales 70 x 25 mm(AxB)
- BC-13-306** 1 Valve centrale 84 x 24 mm (AxB)

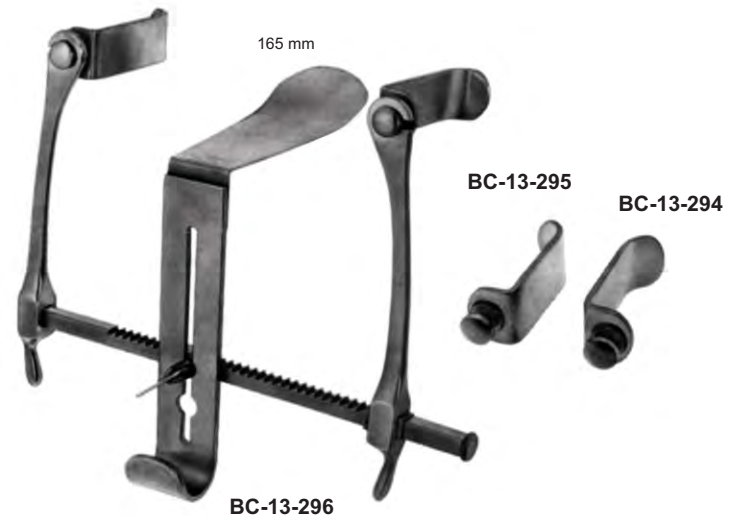

Millin

BC-13-307

21.5 cm

Bladder retractor, complete, consisting of:

- BC-13-308** 1 Frame
- BC-13-309** 1 Pair lateral Valves 50 x 22 mm (AxB)
- BC-13-310** 1 Pair lateral Valves 63 x 22 mm (AxB)
- BC-13-311** 1 Central Valve 120 x 52 mm (AxB)

Separador para la vejiga , completo, compuesto de:

- BC-13-308** 1 Cuadro
- BC-13-309** 1 Par de Valvas laterales 50 x 22 mm (AxB)
- BC-13-310** 1 Par de Valvas laterales 63 x 22 mm (AxB)
- BC-13-311** 1 Valve central 120 x 52 mm (AxB)

Ecarteur vesical, complet, compose de:

- BC-13-308** 1 Ecarteur
- BC-13-309** 1 Pair de Valvas laterales 57 x 25 mm (AxB)
- BC-13-310** 1 Pair de Valvas laterales 63 x 22 mm (AxB)
- BC-13-311** 1 Valve central 120 x 52 mm (AxB)



Caspar
BC-13-312 17 cm
complete - left
BC-13-312 17 cm
only

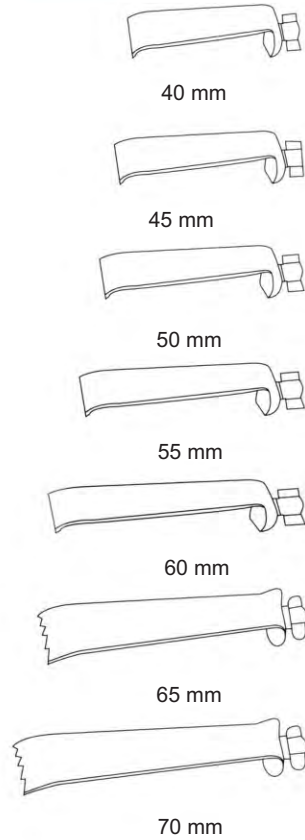

70 x 38 mm 57 x 38 mm



Darling
BC-13-314
16.5 cm
left
BC-13-3152
16.5 cm
right



Rigby
BC-13-316
18 cm



Quervain
BC-13-317

BC-13-318
(pair)
Lateral Blades only
60 x 60 mm



BC-13-319
(pair)
Lateral Blades only
50 x 30 mm

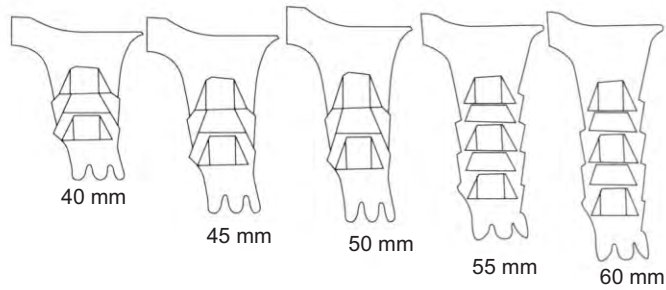

Caspar
BC-13-320



Caspar
BC-13-321
17 cm
complete - right
BC-13-322
17 cm
only

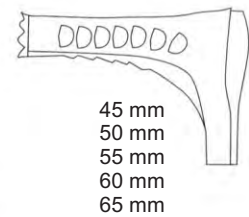
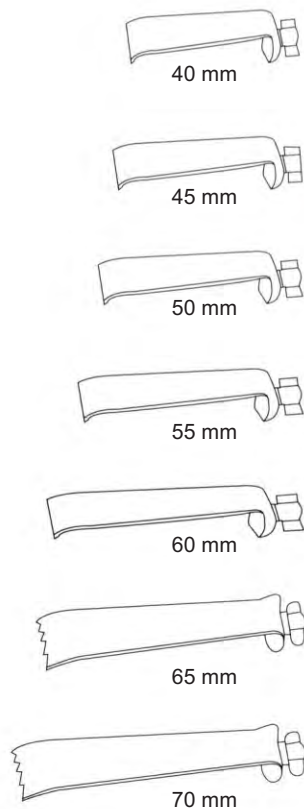

Caspar
BC-13-323



Cloward
BC-13-324
15 cm / 6"

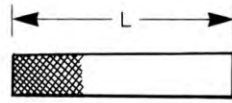

L/mm
30
50
70
90
110



Cloward
BC-13-325
17 cm / 6 3/4"



Cloward
BC-13-326
16 cm

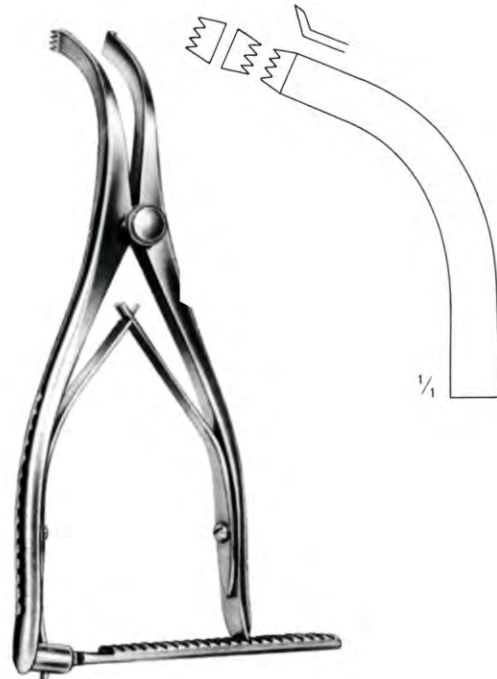

Inge
BC-13-327
16.5 cm / 6 1/2"



2 flat jaws
 bocas llanas
 mors plats



Inge - flat
BC-13-328
 24 cm / 9½"
 Blade opening 50 mm / 2"
 Abertura de la hoja 50 mm
 Ecartement 50 mm

2 cupped jaws
 bocas forma de copa
 mors forme cuiller



Inge - curved
BC-13-329
 24 cm / 9½"
 Blade opening 50 mm / 2"
 Abertura de la hoja 50 mm
 Ecartement 50 mm

serrated jaws
 bocas estriadas
 mors stries



BC-13-330
 28 cm / 11"
 Blade opening 75 mm / 3"
 Abertura de la hoja 75 mm
 Ecartement 75 mm



Caspar
BC-13-331
complete 5 blades
BC-13-332
11.5 cm
only
opening 8.5 cm



45 x 23 mm (AxB)



50 x 23 mm (AxB)



55 x 23 mm (AxB)



60 x 23 mm (AxB)



65 x 23 mm (AxB)



**WELMED Instrument Company
Defence Road, Near Wapda Grid Station
Sialkot 51310, Pakistan.**

Phone : +92 52 3554782, 3558704

Fax : +92 52 3550296

📞 Mobile : +92 333 8680640

Email : welmedpk@gmail.com

info@welmedinst.com

wmm@brain.net.pk

welmed@cyber.net.pk

Website : www.welmedinst.com