



Serving Humanity Since 1908

WELMED
INSTRUMENTS CO.

**Orthopedic Catalogue
Group 14**



Manufacturers & Exporters of Quality Surgical Instruments

Orthopedic Instruments



Bone Surgery 14

WELMED Instruments Company
Defence Road
Near Wapda Grid Colony
Sialkot 51310, Pakistan.

Phone : +92 52 3554782, 3558704
Fax : +92 52 3550296
Cell : +92 333 8680640

Email : info@welmedinst.com
welmedpk@gmail.com
wmm@brain.net.pk
welmed@cyber.net.pk

Website : www.welmedinst.com

About Us

Quality begins at **WELMED** Instruments Company where master craftsmen forge and manufacture each instrument to its exact specifications and measurements. Instruments must undergo a series of quality control inspections in order to be worthy of **WELMED** name and warranty. We offer a wide selection of medical instruments including Surgical and Dental instruments.

We have acquired a unique and unmatched understanding of manufacturing through a large experience, working since 1908. Years of experience & state of the art manufacturing facilities helped us to keep our prices low. Our Surgical & Dental instruments are created by expert craftsmen, providing unfaltering quality you can rely on.

We have launched a fully interactive website where you can get online and track your orders 24 hours a day, 7 days in a week, and 365 days a year. Ask for our free e-catalogue on CD-Rom to save time and enjoy hassle free ordering.

We provide our customers with most reliable customer service as your satisfaction is our top priority. Our customers always enjoy our wonderful customer service and quality tools at the best price.

Lastly we invite you to have a work experience with **WELMED** Instruments Company and we will prove ourselves as one of the most valuable source you have.

You can find us at

WELMED Instruments Company
Defence Road, Near Wapda Grid Colony
Sialkot 51310, Pakistan.

Phone : +92 52 3554782, 3558704
Fax : +92 52 3550296
Cell : +92 333 8680640

Emails :
Info@welmedinst.com
welmedpk@gmail.com
wmm@brain.net.pk
welmed@cyber.net.pk

Website : www.welmedinst.com



History

WELMED Instruments Company was founded in 1995. Our Great Grandfather **Mian Muhammad Fazal Elahi** was the founder of M/s M.F. Elahi & Company (E.P.) Pvt. Ltd, established in 1908. WELMED is a sister concern of M.F. Elahi & Co. It is our pride to be a member of M.F. Elahi Family.

WELMED Instruments Company is located in the heart of beautiful city, Sialkot, Pakistan. We are manufacturers and exporters of quality Surgical, Dental instruments and Scissors of all sorts in various categories. We are closely attached with highly skilled surgeons and other technicians of the surgical industry to make the new instruments development possible.

WELMED is in a continuous process of development and testing of new instruments for their precision and perfect functioning. We are also working at imported forging supply by foreign customers.

Certificates

WELMED Instruments Company has achieved the certificates for ISO-9001, ISO-13485, cGMP (FDA) and CE Marking.

Quality Control

All material used in the manufacturing of our instruments are tested from relevant laboratories. Our continuous quality control is our best warranty so that you built confidence in our products.

Deliveries

Deliveries are quick and in-time.

Mode Of Payment

Terms of Payment is ADVANCE or LETTER OF CREDIT (Irrevocable)

Quality Policy

WELMED Instruments Company aims to produce quality Surgical, Dental instruments and Scissors of all sorts at reasonable prices to become an exemplary manufacturer. Our total emphasize is to achieve customer's satisfaction by clearly understanding their requirements and following a quality management system which is a primary concern of all our work force. We do our best to produce instruments of finest quality.

<p><i>Certificate of Registration</i></p>  <p>The Governing Board of Q.A. International Certification Limited hereby grants to:</p> <p>WELMED INSTRUMENTS CO. Registration No. QAIC / PK / 1224 - B</p> <p><i>(hereinafter called the Registered Company) the right to be listed in the Directory of Registered Companies in respect of the services listed below. These services shall be offered by the Registered Company at or from only the address given below in accordance with the quality management system in compliance with the Requirements of ISO 13485:2016.</i></p> <p>Address to which this Certificate refers: Defence Road, Near Wapda Grid Station, Sialkot - Pakistan</p> <p>Approved Scope to which this Certificate refers: Manufacture of Non-Active Surgical and Dental Instruments <i>(Please note that the above scope represents the certified activity of the named organization and as such, the organization may undertake additional activities that are not covered under this certification).</i></p> <p>Signed for and on behalf of the Board</p>  <p>CHIEF EXECUTIVE SCHEME MANAGER</p> <p>Certificate Issue Date: 14th July 2018 - Certificate Renewal Before: 13th July 2019 Date of Initial Registration: 14th July 2009 - Re-Certification Before: 13th July 2020 This Certificate of Registration is granted subject to the Regulations approved by the Board.</p> 	<p><i>Certificate of Registration</i></p>  <p>The Governing Board of Q.A. International Certification Limited hereby grants to:</p> <p>WELMED INSTRUMENTS CO. Registration No. QAIC / PK / 1224 - A</p> <p><i>(hereinafter called the Registered Company) the right to be listed in the Directory of Registered Companies in respect of the services listed below. These services shall be offered by the Registered Company at or from only the address given below in accordance with the quality management system in compliance with ISO 9001:2015.</i></p> <p>Address to which this Certificate refers: Defence Road, Near Wapda Grid Station, Sialkot - Pakistan</p> <p>Approved Scope to which this Certificate refers: Manufacture of Surgical and Dental Instruments <i>(Please note that the above scope represents the certified activity of the named organization and as such, the organization may undertake additional activities that are not covered under this certification).</i></p> <p>Signed for and on behalf of the Board</p>  <p>CHIEF EXECUTIVE SCHEME MANAGER</p> <p>Certificate Issue Date: 14th July 2018 - Certificate Renewal Before: 13th July 2019 Date of Initial Registration: 14th July 2009 - Re-Certification Before: 13th July 2020 This Certificate of Registration is granted subject to the Regulations approved by the Board.</p> 	<p>CERTIFICATE</p>  <p>Application of Council Directive 93/42/EEC as updated directive 2007/47/EC for Class I Medical Devices This is certifying that the products submitted are:</p> <p>CLASS I MEDICAL DEVICES (Re-Useable, Non-Powered Surgical and Dental Instruments)</p> <p>Registration No. DCS/9904155</p> <p>Manufactured By: WELMED INSTRUMENTS CO. Defence Road, Near Wapda Grid Station, Sialkot-Pakistan</p> <p>Comply with the applicable requirements of the Directive 93/42/EEC as updated directive 2007/47/EC for Class I Medical Devices</p> <p>The Technical file of the products have been assessed according to the procedure of Conformity Assessment described in the Annex -I, Annex VII.</p> <p>Limitations: The manufacturer must inform DCS of any substantial changes occurred in the Product or process in order to examine whether this certificate remains valid. Conformance to all the regulatory requirements is the sole responsibility of the manufacturer including the appointment of EU Authorized Representative and registration with concerned competent authority.</p> <p>CHAIRMAN SCHEME MANAGER</p>  <p>Certificate Issue Date: June 20, 2018 Certificate Expiry Date: June 29, 2019</p> <p>www.itsmmcertification.org</p> 
---	---	--

Warranty

All WELMED Instruments are produced from finest stainless steel available to be free from any defect in material or workmanship. Any product that proves to be defective in material or workmanship will either be repaired or replaced without any charge. This warranty is void if the instrument is abused, altered, modified or is not used in the manner for which it is intended.

Bone Surgery

14



VELMED
INSTRUMENTS CO.

Adson	77, 12	Gerster	9
Alderdyce	62	Gouge For Removing Broken Screw	87
Alexander Osteotome	86	Gouge	88-93
Aufricht	81	Hackstock With Longitudinal	39
Barth	52	Halle	57, 70
Bending And Cutting Plier	32	Hemingway	52
Bending Plier	32	Hoehn	74
Bennett Bone Lever	69	Hohmann	66-68
Beyer	11, 13	Hohmann Bone Lever	68
Becon	12	Hohmann-Aldinger	68
Bier	57, 61	House	51
Bircher	27	Hoke	84
Bircher-Ganske Forcep	19, 24	Howard	71
Blount Bone Lever	68	Hudson (Hand Drill)	33
Blount Retractor	20, 25	Jackson	29
Blumenthal	10	Jacobs	34
Bohler	13, 43	Jansen	11, 75, 52
Bone Curette Swedish Pattern	53	Joseph Bone Flies	80, 87
Bone Files	78, 79	Joseph Raspatories	70
Bone Lever	60	Kazanjian	20
Brand Tendon Holding Forcep	25, 30	Kern-Lane	4
Brawley	81	Kern-Mini	4
Bruns	50-51, 56	Key Raspatorie	77
Buck-Gramcko	61, 64	Killian Raspatories	71
Canad-Modell	27	Kleinert-kutz	12
Caspar	73	Konig	70
Carroll	31	Koppelman-Leibinger	36
Charriere Resection Saw	56	Krischner With Traction Hook	43
Charriere	60	Lambotte Osteotome	5, 6
Chisel	80, 82, 85-87	Lowman	9
Cleveland	16, 20	Lowman-Lambert	9
Cobb Spinal Gouges	89	Lowman-Hoglund	9
Cobb	59, 73, 77-79	Lambotte	6, 85
Collin Mallet	46	Landolt	73
Combi-Flat Nose Plier	33	Lane	4
Cottle Mallet	41	Lange-Hohmann	65
Cottle Osteotomes	81	Langenbeck Amputation	60
Cottle	46, 73, 85	Langenbeck Bone Holding	3, 63
Daubenspeck	52	Langenbeck Elevator	75
Demel Wire Guides	37	Langenbeck	3, 75, 60
Demel	44	Leksell-Stille	15
Dingmann	3	Leksell	17
Doyen	45	Lempert	10, 11, 52, 57
Echlin	14	Lewin	1
Extension Bows	37, 39	Lewis	80
Farabeuf	76	Lexer Gouge	90
Farabeuf-Collin	76	Lexer Osteotome	90, 89
Farabeuf-Lambotte	5	Lexer Spongiosa Gouge	92
Fergusson	3	Liston	20, 22
Finger Ring Saw	23	Littauer-Liston	20
Fisch	12	Listen Key	23
Flat Nose Plier Pointed	34	Loute Wire Tightner	42
Flat Nose Plier	33	Lowman09	9
Fomom	83	Lowman-Hoglund	9
Freer Chisel	80	Lowman-Hambert	9
Freer	84	LucaeMallet	46
Frykholm	15	Lucas	52
Gallaher	80	Luer	11, 10



Luer-Friedman	10	Sebileau	63
Luer-Stille	14,16	Sedillot	74
Mallet Made Of Plastic Without Lead	43	Self-Centering With Thread	7
Mallet Plastic Handle	44	Semb	18, 23
Maltz Raspatorie	77	Sequestrum Forcep	2
Marquardt	14, 81	Sewall	70
Martin Meniscus Forcep	19	Simon	58
Martin "Gigant- Compact	35	Smillie Knife	27, 25
Martin Cutter Front Action	35	Smillie Retractor	27
Martin Wire Twisting Forcep	31	Smith-Peterson	17
Martin	29, 24, 34, 36	Spongiosa Gouge	88
Martini	40, 46	Spratt	55
Mayfield	51	Steinmann	29
Mc Donald	58	Stellbring	11
Mc Indoe	17, 21, 62	Stille Chisel	87
Mc Kenty Raspatories	66	Stille Drill	32
Mead Mallet	47	Stille Gouge	87
Mead	10	Stille Osteotome	87
Miller	80	Stille	87, 32
Mini-Hohmann	64	Stille-Liston	23
Mini-Lambotte	85	Still-Luer	18
Mini-Lexer	90	Still-Ruskin	16
Modelling Plier	32	Stille-sherman (Hand Drill)	32
Mod-Usa Curette	49	Tendon Interlacing Forcep	31
Mod-Usa	54	Tendon Seizing Forcep	30
Moore (Hand Drill)	35	Trelat	70
Muhking	72	TC H/Gold	37
Murphy-Lane	69	Uffenorde	54
Nail Splitting Forcep	23	Ulrich	6
Neff Meniscus Knife	21	Van Buren	2
Olivecrona	12, 26	Verbrugge With Lip Joint	8
Osteotome Set With Blade	84	Verbrugge=Muller Bone Lever	67
Osteotome	80-82	Vickers Mallet	50
Partsch Mallet Made Of Plastic	47	Volkman Bone Curette	53, 50
Percy Amputation Retractors	55	Volkman Spoon	50, 55
Peiper-Beyer	18	Volkman Artifical Wood Handle	59
Petella Forcep	02	Wagner	65
Plastic Handle Mallets	44-45	Wagner	79
Plate Cutter	32	Walton-Liston(Bohler)	21
Putti Bone Files	82	Watson-Cheyne Dissector	62
Quervain	63	Watson-william	81
Radolf Nail Extracting Forcep	28	West	84
Raspatories With Artifical Handle	74	West Gouge	84
Resposition Forcep	1	Wiener	81
Resposition	1, 2	Williger Elevator	47, 45
Rottgen-Ruskin	16	Williger Mallet	62
Ruskin Bone Cutter	17	Williger	45, 47, 53, 54, 62, 70
Ruskin	13, 14, 21	Wire Cutting Plier For Soft	41, 40-44
Ruskin-liston	17, 21	Wire Cutting Pliers	37, 44, 41, 40
Rust	26, 61	Wire Twisting Forcep T/Carbide	36
Salenius Knife	21	With Crosswise Groove Plier	39
Sauerbruch-Still	19	Zaufal-jansen	13
Sauerbruch-Coryllos	19	Zielke Gouge For Scoliosis Operation	91
Satterlee	56, 60		
Schede	50		
Schell	12		
Schneider	76		
Schneider-Sauerbruch	76		



BC-14-101
13.5 cm
for maxillary reposition
para la reduccion maxilar
Pour reposition du maxilaire



BC-14-102
13 cm
for small fragments
para fragmentos pequenos
Pour petits fragments



BC-14-103
20.5 cm



BC-14-104
13.5 cm



BC-14-105
14 cm



Lewin
BC-14-106
17.5 cm



BC-14-107
 17 cm
 Reposition forceps
 Pinza para reduccion
 Pince a reduction



BC-14-108
 24 cm
 Reposition forceps
 Pinzas para reduccion
 Pinces a reduction
 Pince a reduction



BC-14-109
 18.5 cm
 Patella forceps
 Pinzas para rotula
 Pince patella
 Pinza per rotula



BC-14-110
 20 cm
 Sequestrum forceps
 Pinzas para secuestro
 Pinza a sequestre



BC-14-111
 20 cm
 Sequestrum forceps
 Pinzas para secuestro
 Pinza a sequestre



Van Buren
BC-14-112
 20 cm
 Sequestrum forceps
 Pinzas para secuestro
 Pinza a sequestre



2 x 2 Teeth

Dingmann
BC-14-113
18.5 cm



2 x 2 Teeth

Dingmann modif.
BC-14-114
18.5 cm



2 x 2 Teeth

BC-14-115
20 cm



2 x 2 Teeth

Langenbeck
BC-14-116
19.5 cm



4 x 4 Teeth

Fergusson
BC-14-117
20.5 cm

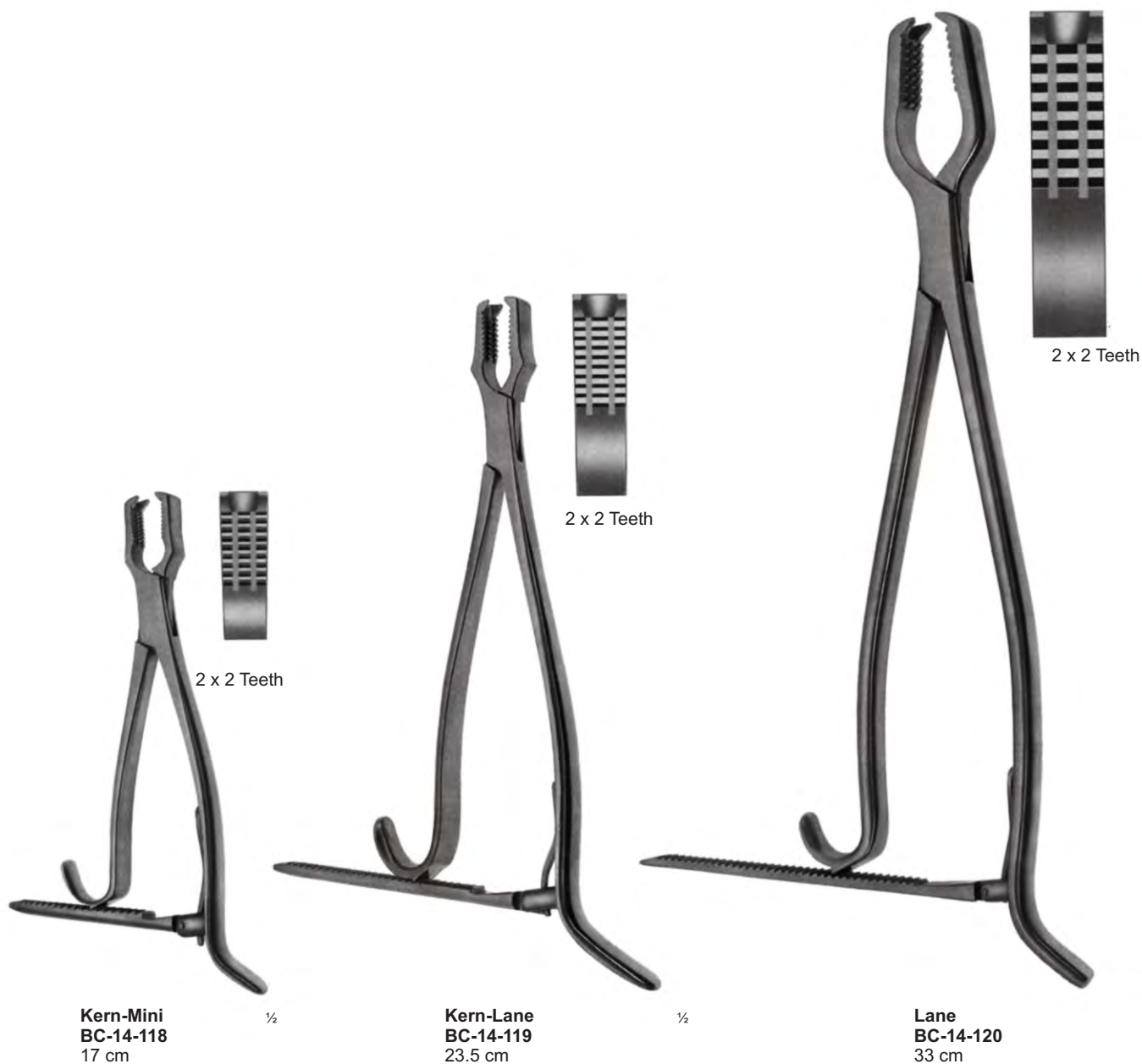



Farabeuf-Lambotte
BC-14-121
25.5 cm
Adjustable
ajustable
a cremaillere



Lambotte
Adjustable, 1 jaw swiveled
ajustable, a mandibula, movable
a cremaillere, 1 mors mobile



9 mm

BC-14-122
22 cm



10 mm

BC-14-123
27 cm



11 mm

BC-14-124
30.5 cm



14 mm



Lambotte
BC-14-125
21 cm
adjustable, 1 jaw swiveled
ajustable, 1 mandibula movable
a cremallere, 1 mors mobile



Ulrich



5.0 mm

BC-14-126
18 cm



7.5 mm

BC-14-127
23 cm



8.0 mm

BC-14-128
25 cm



8.5 mm

BC-14-129
28 cm



2.5 mm



BC-14-130
15 cm

6.5 mm



BC-14-131
19 cm

9.5 mm



BC-14-132
24 cm

10.0 mm

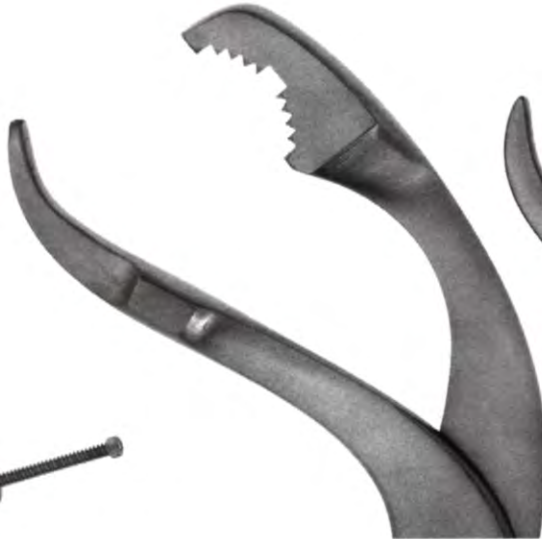

BC-14-133
26 cm

11.0 mm



BC-14-134
28 cm



Self-centring forceps with thread fixation
autocentrante con cremallera de tuerca
autostatique, a cremallere



6 mm



BC-14-135
17.5 cm

9 mm



BC-14-136
25 cm

12.5 mm



BC-14-137
26.5 cm

BC-14-138
27 cm

11.5 mm



Verbrugge

with lip joint
con cierre de labio
avec fermeture a lambeaux



Lowman
BC-14-139 12 cm
BC-14-140 18 cm
BC-14-141 21 cm



Lowman
BC-14-142 12 cm
BC-14-143 18 cm
BC-14-144 21 cm



Lowman-lambert
BC-14-145
21 cm



Lowman-Hoglund
BC-14-146
18 cm
1 jaw swiveled
1 mandibula movable
1 mors mobile



Gerster
BC-14-147
Traction bar for bone clamps
Barra de traccion para pinzas porta-huesos
Tracteur pour daviers



2.5 mm

Luer-Friedman
BC-14-148
13 cm

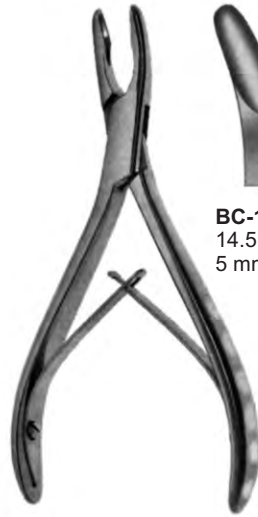

Luer



BC-14-149
14.5 cm
5 mm



BC-14-150
14.5 cm
5 mm

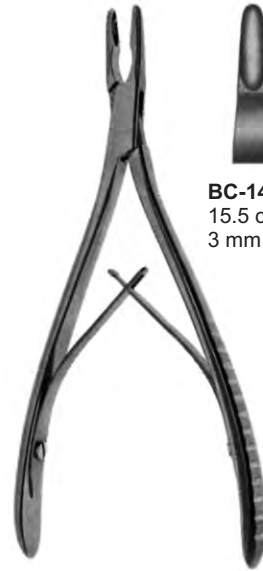

Lempert



BC-14-151
15.5 cm
3 mm



BC-14-152
15.5 cm
3 mm

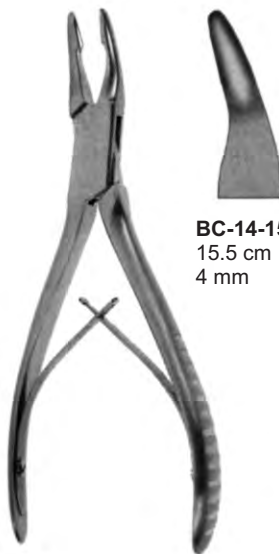

Blumenthal



BC-14-153
15.5 cm
4 mm



BC-14-154
15.5 cm
4 mm



BC-14-155
15.5 cm
4 mm

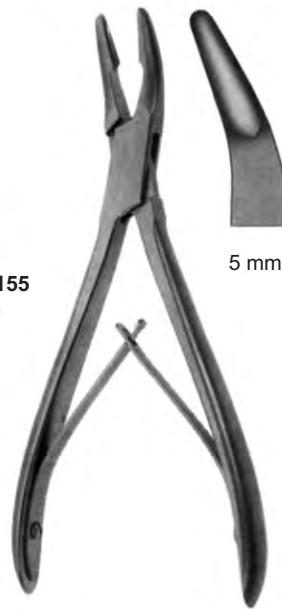

Mead
BC-14-156
16.5 cm



5 mm



Mead
BC-14-157
16.5 cm



5 mm

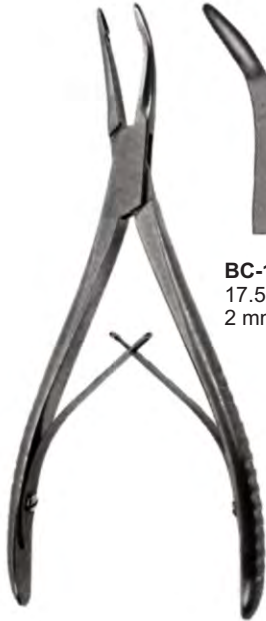

Stellbring



BC-14-158 17.5 cm
2 mm

BC-14-159 17 cm
2 mm

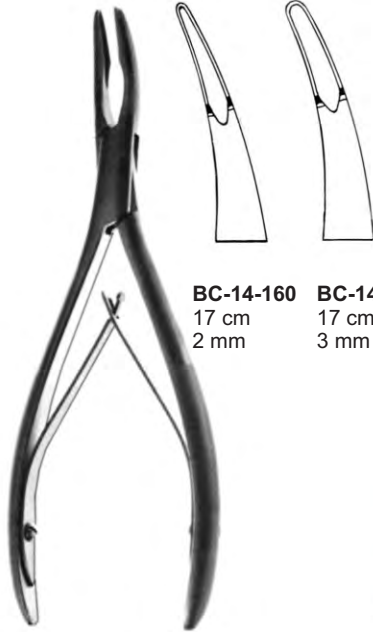

Beyer

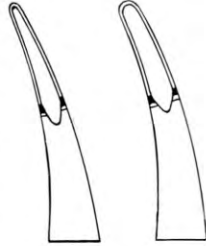

BC-14-160 17 cm
2 mm

BC-14-160A 17 cm
3 mm

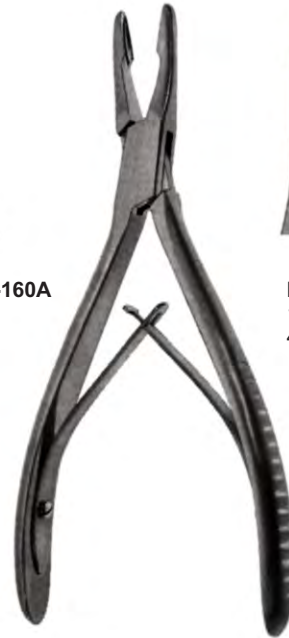

Jansen



BC-14-161 17.5 cm
4 mm

BC-14-162 17.5 cm
4 mm



Lempert



BC-14-163 18 cm
3 mm

BC-14-164 18 cm
3 mm



Jansen
BC-14-165
19 cm



4 mm



Luer



BC-14-166 18 cm
10 mm

BC-14-167 18 cm
10 mm



Adson
BC-14-168
21 cm



Bacon
BC-14-169
20 cm



Olivecrona
BC-14-170
20 cm

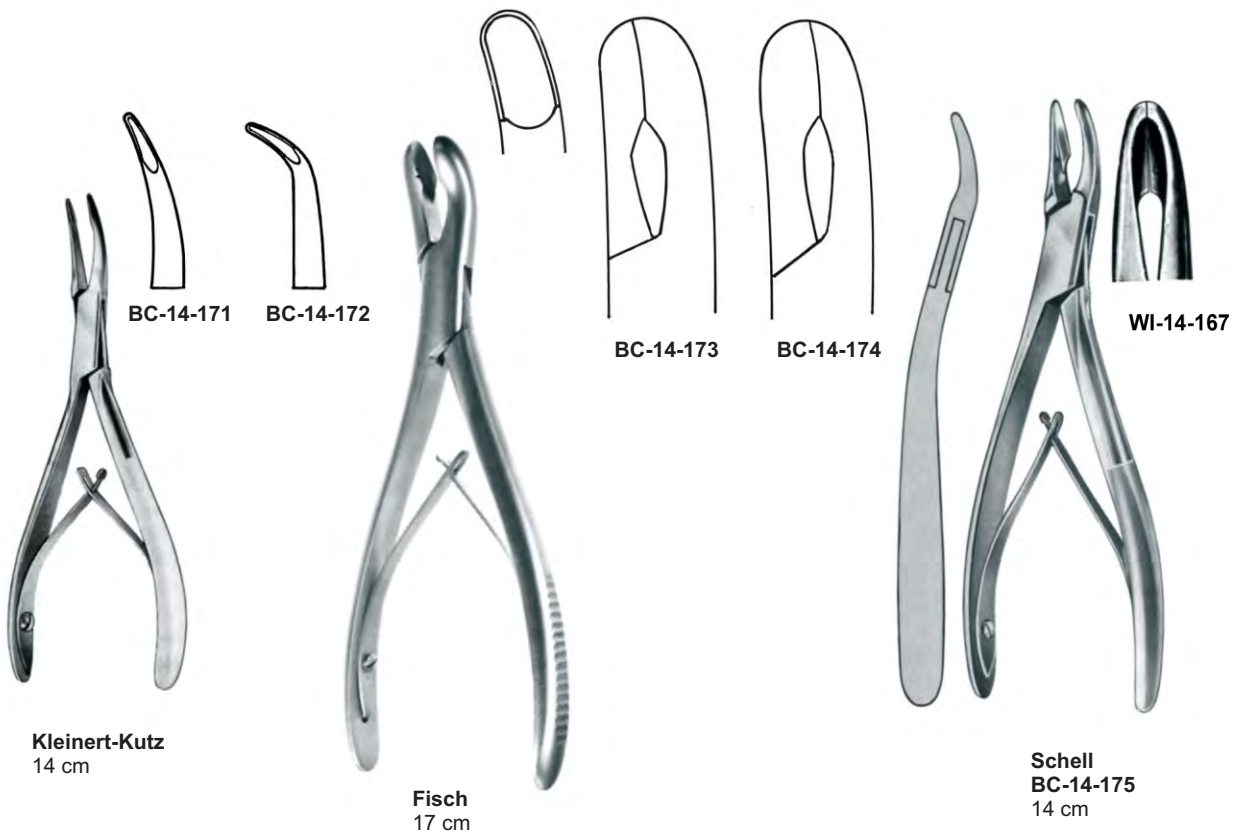

Kleinert-Kutz
14 cm

Fisch
17 cm

Schell
BC-14-175
14 cm



BC-14-176
15 cm
3 mm



BC-14-177
15 cm
4 mm

Bohler



3 mm

Mayfield
BC-14-178
17.5 cm



BC-14-179
18 cm
3 mm



BC-14-180
18 cm
4 mm

Beyer



5 mm

Zaufal-Jansen
BC-14-181
18 cm



5 mm
laterally curved
curva lateral
Courbure laterale

Ruskin
BC-14-182
18 cm



BC-14-183
18 cm
4 mm



BC-14-184
18 cm
6 mm



BC-14-185
18 cm
4 mm



BC-14-186
18 cm
6 mm

Ruskin



Marquardt
BC-14-187
20 cm

3 mm

1/2



Ruskin



BC-14-188
20.5 cm
6 mm



BC-14-189
20.5 cm
6 mm



Luer-Stille

BC-14-190
22 cm
17 mm



BC-14-191
22 cm
17 mm

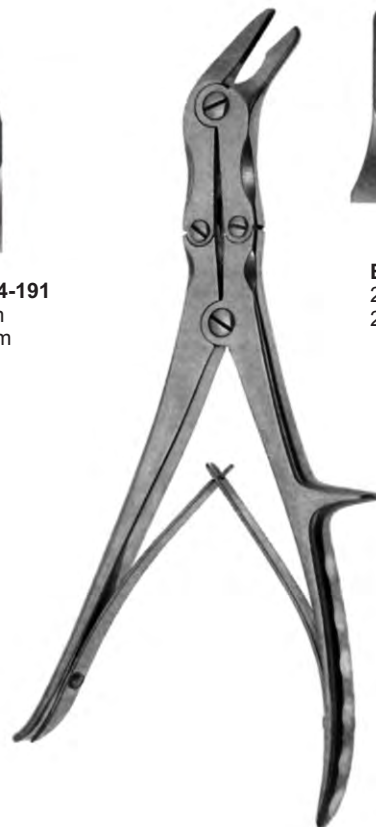

Echlin



BC-14-192
23 cm
2 x 10 mm



BC-14-193
23 cm
3 x 10 mm



BC-14-194
23 cm
4 x 10 mm

Laterally curved
Curvas lateral
courbure laterale

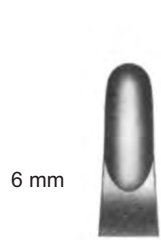

6 mm



3 mm

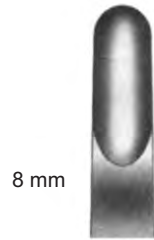

8 mm



3 mm



8 mm

BC-14-196
24.5 cm

BC-14-197
24.5 cm

BC-14-198
24 cm

BC-14-199
24 cm



Stille
BC-14-195
23 cm
Laterally curved
curvas lateral
courbure laterale



Leksell-Stille

Laterally curved
curvas lateral
courbure laterale



Frykholm

Laterally curved
curvas lateral
courbure laterale



8 mm

BC-14-200A
 Curved



5 mm

BC-14-201A
 Curved



10 mm

BC-14-202
 25 cm



10 mm

BC-14-203
 25 cm



17 mm

BC-14-204A
 Curved



Stille-Ruskin
BC-14-200
 23.5 cm
 Straight



Rottgen-Ruskin
BC-14-201
 24 cm
 Straight



Luer-Stille



Luer-Stille
BC-14-204
 27 cm
 Straight



Smith-Peterson
BC-14-205
3 mm, 24 cm



Smith-Peterson
BC-14-206
3 mm, 24 cm



Smith-Peterson
BC-14-207
3 mm, 24 cm



Leksell
23 cm

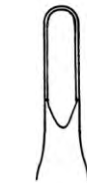

BC-14-208
5 mm



BC-14-209
8 mm



Leksell
23 cm



BC-14-210
5 mm



BC-14-211
8 mm



20 mm

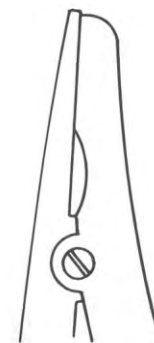

Semb
 BC-14-212 23 cm BC-14-214
 BC-14-213 27 cm BC-14-215
 Straight Curved



Stille-Luer
 BC-14-216
 27 cm



Peiper-Beyer
 BC-14-217
 18 cm

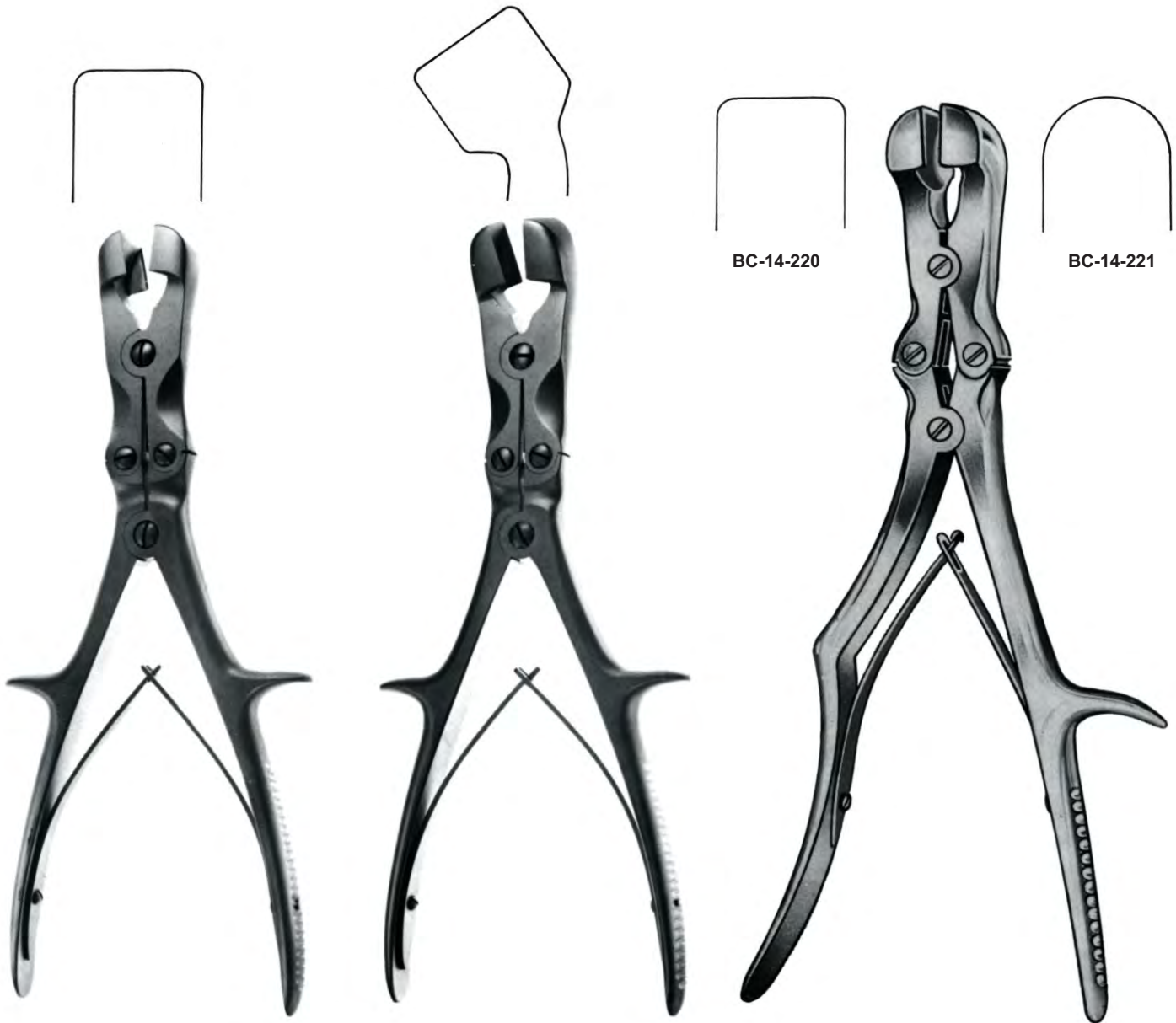

Sauerbruch-Stille
BC-14-218
26 cm

Sauerbruch-Stille
BC-14-219
26 cm

Sauerbruch-Coryllos
30 cm



Littauer-Liston
BC-14-222
 15.5 cm



Kazanjin
BC-14-223
 18.5 cm



Cleveland
BC-14-224
 15 cm



Cleveland
BC-14-225
 17 cm



Liston



BC-14-226
 14 cm

BC-14-227
 17 cm



BC-14-230
 14 cm

BC-14-231
 17 cm



BC-14-228
 19.5 cm

BC-14-229
 22 cm



Liston



BC-14-232
 19.5 cm

BC-14-233
 22 cm



Walton-Liston (Bohler)
BC-14-234
14.5 cm



Walton-Liston (Bohler)
BC-14-235
14.5 cm



Mc Indoe
BC-14-236
17.5 cm



Ruskin
BC-14-237
18 cm



Ruskin
BC-14-238
18 cm



Ruskin-Liston
BC-14-239
18.5 cm



Ruskin-Liston
BC-14-240
18.5 cm



Liston
BC-14-241
24 cm



Liston
BC-14-242
27 cm



Liston
BC-14-243
27 cm

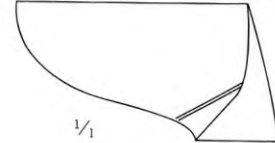
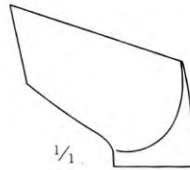
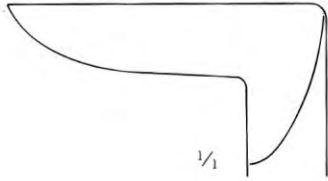

Stille-Liston
BC-14-244
26 cm / 10 1/4"



Listen-Key
BC-14-245
25.5 cm / 10"



Semb
BC-14-246
24.5 cm / 9 3/4"



Martin
BC-14-247
16.5 cm



Martin
BC-14-248
18.5 cm



Martin
BC-14-249
20.5 cm



Bircher-Ganske
BC-14-250
20.5 cm



Bircher-Ganske
BC-14-251
20.5 cm



Bircher-Ganske
BC-14-252
20.5 cm

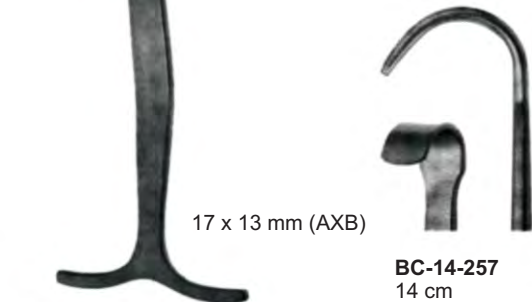
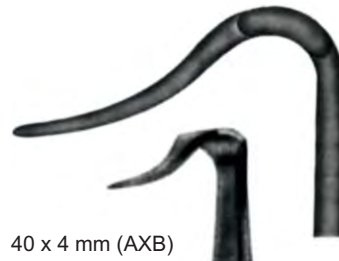
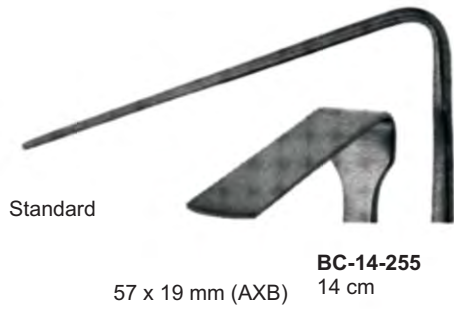
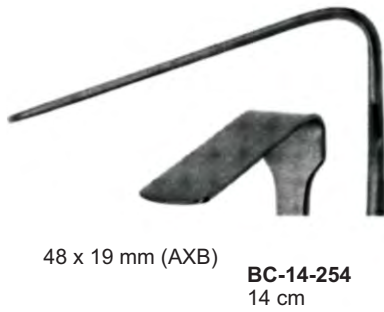
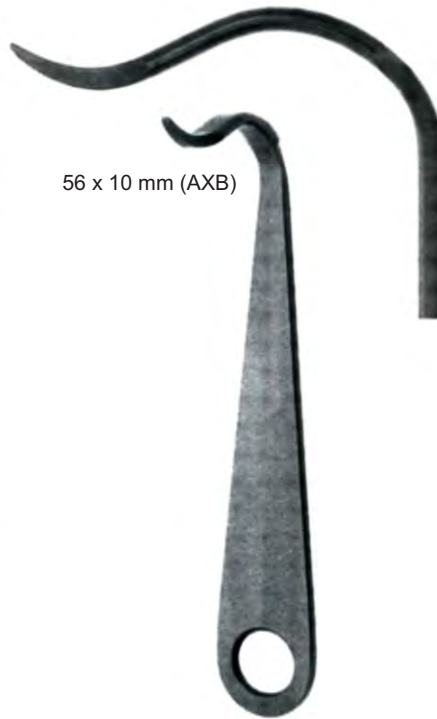

Smillie

Blount
BC-14-259
17. cm



BC-14-261
17.5 cm



Neff BC-14-262
20.5 cm



Neff BC-14-263
20.5 cm



Salenius BC-14-264
22 cm



Salenius BC-14-265
22 cm



Smillie
BC-14-266
17 cm



Smillie
BC-14-267
17 cm



Smillie
BC-14-268
17 cm



Canad-Modell
BC-14-269
20.5 cm



Canad-Modell
BC-14-270
20.5 cm



Bircher
BC-14-271
19 cm



Bircher
BC-14-272
19 cm



Spare saw blade
Hoja de repuesto
Lame de scie de rechange

BC-14-273
16 cm
Finger ring saw
Sierra para abrir anillos
Scie pour bagues



Spare saw blade
Hoja de repuesto
Lame de scie de rechange

BC-14-274
16.5 cm
Finger ring saw
Sierra para abrir anillos
Scie pour bagues



BC-14-275
13 cm
Nail splitting forceps
Pinzas corta-unas
Pince a ongles



Radolf
BC-14-276
13.5 cm
Nail extracting forceps
Pinzas arranca-unas
Pince pour extraction des ongles



BC-14-277
11.5 cm



Jackson
BC-14-278
15.5 cm
4 x 5 teeth
4 x 5 dientes
4 x 5 dent



Steinmann
BC-14-279
15.5 cm



Brand



BC-14-280
15 cm



BC-14-281
19 cm



BC-14-282
24 cm



Brand



BC-14-283
15 cm



BC-14-284
19 cm



BC-14-285
24 cm



BC-14-286
21 cm / 8 1/4"



BC-14-287
21 cm / 8 1/4"



Carroll
BC-14-288
11.5 cm / 4 1/2"



BC-14-289
15 cm
Tendon Interlacing Forceps
Pinzas para entrelazar tendon
Pincas pour entrelacer les tendons



BC-14-290
15 cm
Tendon Interlacing Forceps
Pinzas para entrelazar tendon
Pincas pour entrelacer les tendons



Complete with three twist drills ref.
Completo con tres brocas ref.
Complet avec trois fraises ref.
BC-14-262 - BC-14-264

Stille-Sherman
BC-14-291
24 cm



Complete with nine twist drills ref.
Completo con nueve brocas ref.
Complet avec neuf fraises ref.
BC-14-262 - BC-14-270

Stille
BC-14-292
20.5 cm



BC-14-293
2.5 mm \emptyset
Twist Drill
Broca espiral
Meche helicoidale



BC-14-294
3 mm \emptyset
Twist Drill
Broca espiral
Meche helicoidale



BC-14-295
3.5 mm \emptyset
Twist Drill
Broca espiral
Meche helicoidale



BC-14-296
4 mm \emptyset
Twist Drill
Broca espiral
Meche helicoidale



BC-14-297
10 mm \emptyset
Trepine
Trepano
Trepan



BC-14-298
5 mm \emptyset
Spherical Burr
Fresa esferica
Fraise spherique



BC-14-299
8 mm \emptyset
Spherical Burr
Fresa esferica
Fraise spherique



BC-14-300
12 mm \emptyset
Spherical Burr
Fresa esferica
Fraise spherique



BC-14-301
16 mm \emptyset
Spherical Burr
Fresa esferica
Fraise spherique



BC-14-302
1 mm \emptyset
Twist Drill
Broca espiral
Meche helicoidale



BC-14-303
1.5 mm \emptyset
Twist Drill
Broca espiral
Meche helicoidale



BC-14-304
2 mm \emptyset
Twist Drill
Broca espiral
Meche helicoidale



BC-14-314
Fig. 9
Extension piece
Pieza de prolongacion
Piece de rallonge



BC-14-306
Fig. 1
Conical Burr
Fresa conica
Fraise conique



BC-14-307
Fig. 2
Conical Burr
Fresa conica
Fraise conique



BC-14-308
Fig. 3
Spherical Burr
Fresa esferica
Fraise spherique



BC-14-309
Fig. 4
Spherical Burr
Fresa esferica
Fraise spherique



BC-14-310
Fig. 5
Flat Trephine
Taladro plano
Fraise plate



BC-14-311
Fig. 6
Twist Drill
Broca espiral
Meche helicoidale



BC-14-312
Fig. 7
Burr
Fresa
Fraise



BC-14-313
Fig. 8
Burr
Fresa
Fraise



Hudson
BC-14-305
28 cm

Complete, with burrs number 1-4 and extension piece
completo, con fresas number 1-4 y pieza de extension
complet, avec fraises no 1-4 et piece de rallonge



BC-14-316
Twist Drill
Broca espiral
Meche helicoidale

Set of 3
juego de 3
jue de 3

2x = 70 x 3.2 mm
1x = 90 x 3.2 mm



BC-14-318
Wrench
Llave
Cle'



BC-14-315



BC-14-317



Jacobs
BC-14-319
6.35 mm
Mandril de sujecion
Mandrin a trois
Machoirs

With borchart shaft
con vastago borchart
avec tige brochart

Max. Opening
abertura max
pour montage de tiges jusqu'a

Complete with a set of twist drills ref. BC-14-287
Completo con un juego de brocas ref. BC-14-287
Complet avec un jeu de fraises ref, BC-14-287

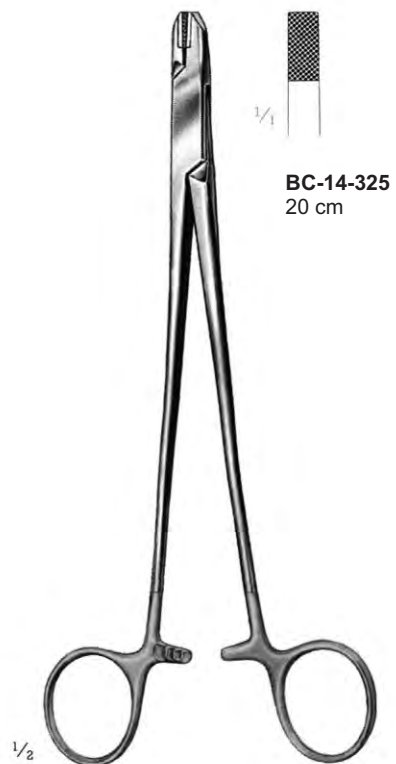

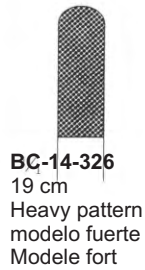
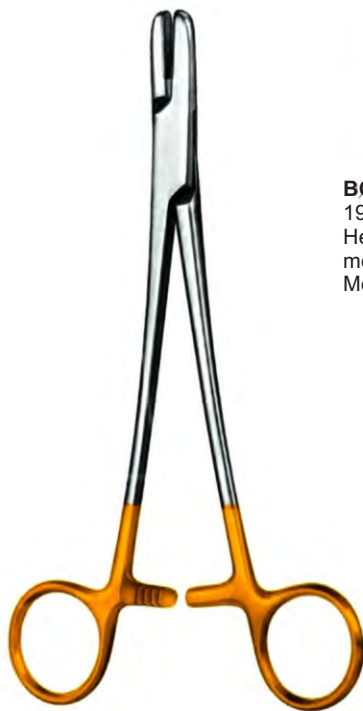

BC-14-326
 19 cm
 Heavy pattern
 modelo fuerte
 Modele fort

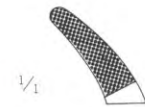
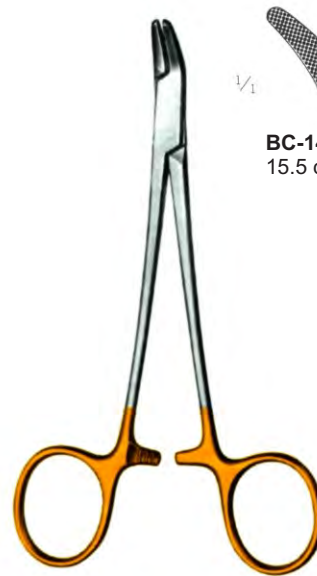

BC-14-327
 15.5 cm

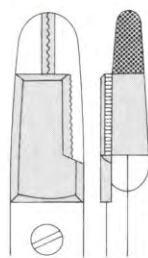

BC-14-328
 18.5 cm



BC-14-329
 18.5 cm
 Regular

Martin
 Combi-Wire Twisting Forceps
 Combi-Pinza de alambre
 Combi-Pince a torsader le fil

Koppelman-Leibinger



TC - H/Gold

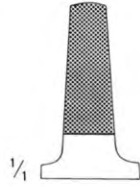

BC-14-330
20 cm / 8"

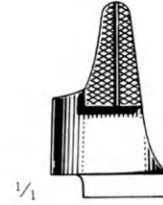

BC-14-331
15 cm
for bending and cutting
para cortar y doblar
pour plier et couper



BC-14-332
13.5 cm
Modelling pliers



BC-14-333
13.5 cm
Modelling pliers



BC-14-334
12.5 cm
bending pliers



BC-14-335
18 cm
plate cutter



TC-H/Gold



BC-14-336
18 cm

Plier with 2 mm delicate tip can be
 Used to remove up to 1.6 mm k-wires
 From hard-to-reach areas

Plier with 3 mm and 5 mm jaws
 Can be used to grasp all sizes
 For wires and pins

Parallel grip
 accion paralela
 action parallele



BC-14-337
18 cm



BC-14-338
18 cm



BC-14-339
13.5 cm
3 mm



BC-14-340
18 cm



BC-14-341
18 cm



BC-14-342
18 cm

Parallel grip
 accion paralela
 action parallele

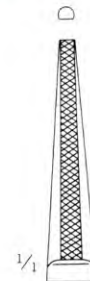

BC-14-343
18 cm
3 mm



BC-14-344
18.5 cm
accion paralela
action parallele
afferramento paralelo
rostfrei
stainless steel
acero inoxidable



Bc-14-345
20.5 cm
stainless steel
acero inoxidable
acier inoxydable

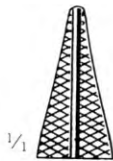
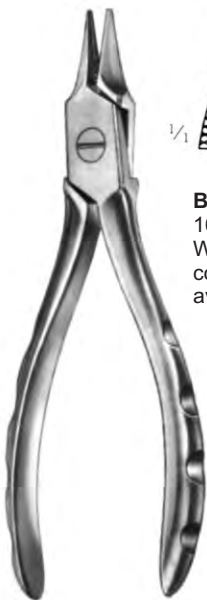

BC-14-346
16 cm
With longitudinal groove
con ranura longitudinal
avec rainure longitudinale



BC-14-347
17.5 cm

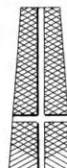

BC-14-348
17 cm
With crosswise groove
Con ranura en forma de cruz
avec rainures croisees

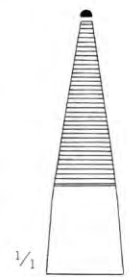

BC-14-349
19.5 cm

Hackstock

Flate Nose Pliers, Pointed
Alicates planos/agudos
Pincas plates/aigues



BC-14-350
18.5 cm

2.4 mm \emptyset
For soft wires up to
para alambres blandos hasta
pour fils mous jusqu'a'

1.8 mm \emptyset
for hard wires up to
para alambres duros hasta
pour fils durs jusqu'a'



Martin "Diamant"
BC-14-351
16 cm

2.2 mm \emptyset
For soft wires up to
para alambres blandos hasta
pur fils mous jusqu'a'

2.0 mm \emptyset
for hard wires up to
para alambres duros hasta
pour fils durs jusqu'a'

Wire cutter, front action
Alicate frontal para cortar alambre
Pinces coupantes frontales





Demel

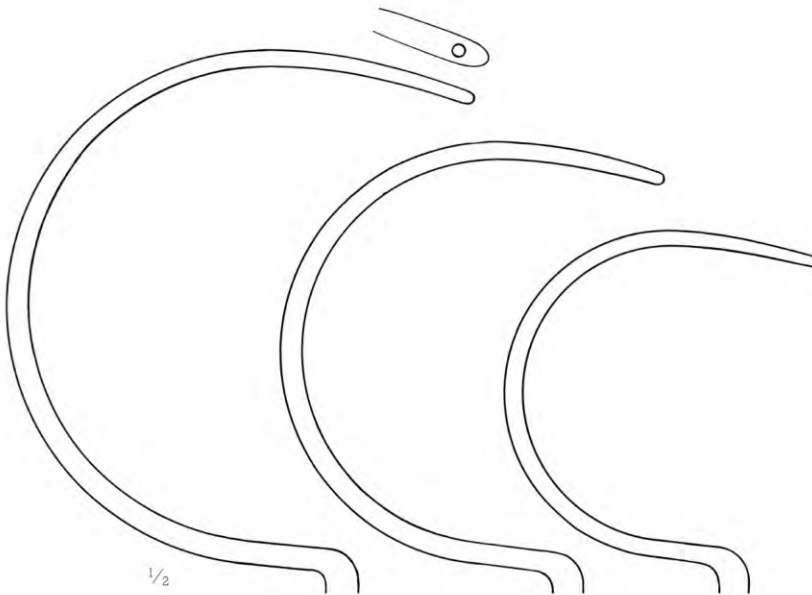

BC-14-358
 Fig. 1
 31 cm

BC-14-359
 Fig. 2
 29 cm

BC-14-360
 Fig. 3
 28 cm



Loute
BC-14-361
 21 cm

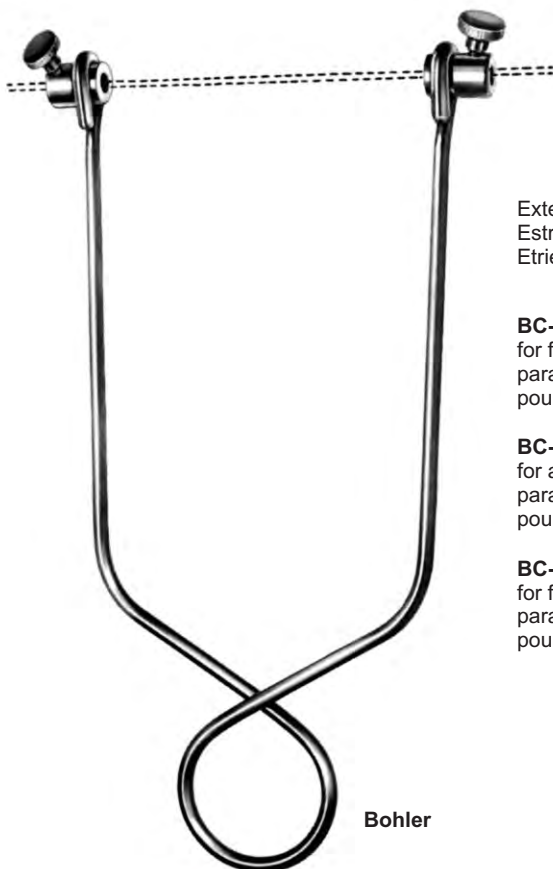

Bohler

Extension Bows
 Estribos para extension
 Etriers a extension

BC-14-362 210 x 150 mm
 for femur & knee
 para femur y rodilla
 pour femur et genou

BC-14-363 160 x 90 mm
 for arm
 para brazo
 pour bras

BC-14-364 210 x 110 mm
 for femur & knee
 para femur y rodilla
 pour femur et genou



Krischner
with 3 traction hook
con 3 ganchos de traccion
avec 3 crochets de traction

BC-14-370
18.5 cm
small pattern
modelo pequeno
modele petit
BC-14-371
26.5 cm
large pattern
modelo largo
modele grand

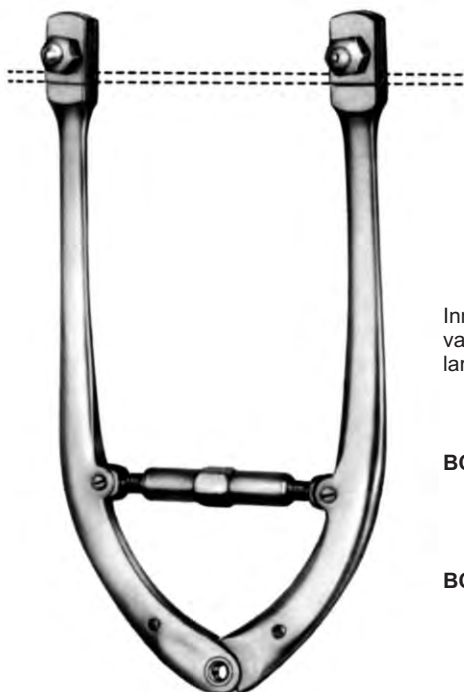

Inner width
 vano
 largeur ouverte

BC-14-372 180 x 100 mm

BC-14-373 270 x 160 mm

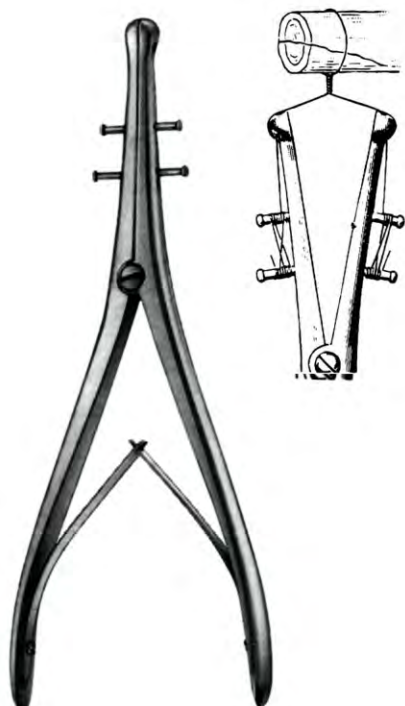

Demel
BC-14-374
 270 mm, 10³/₄"
 Drahtspannzange
 Wire tightening and twisting forceps



BC-14-375
 23 cm / 9"



BC-14-376
 25 cm / 9³/₄"
 soft wire 2.3 mm
 hard wire 1.7 mm



BC-14-377
24 cm

Head cabeza tete	Weight peso poids
26 mm ø	300 gr.

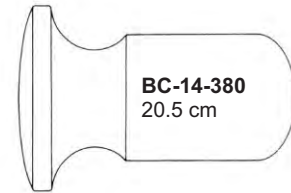

BC-14-380
20.5 cm

Head cabeza tete	Weight peso poids
25 mm ø	120 gr.

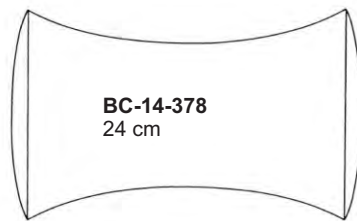

BC-14-378
24 cm

Head cabeza tete	Weight peso poids
28 mm ø	340 gr.

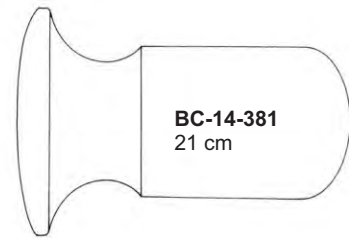

BC-14-381
21 cm

Head cabeza tete	Weight peso poids
30 mm ø	180 gr.



BC-14-379
24 cm

Head cabeza tete	Weight peso poids
30 mm ø	400 gr.

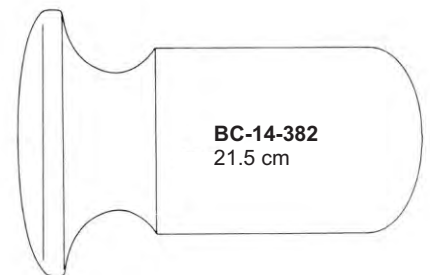

BC-14-382
21.5 cm

Head cabeza tete	Weight peso poids
35 mm ø	260 gr.



Williger
lead filled
relleno de plomo
remplissage de plomb



Doyen



30 mm \varnothing
Head
cabeza
tete

220 gr.
Weight
peso
poids

Collin
BC-14-383
20 cm

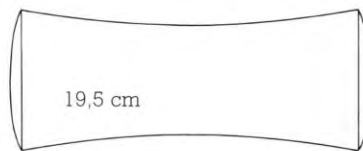

BC-14-384

19 mm \varnothing
Head
cabeza
tete

230 gr.
Weight
peso
poids

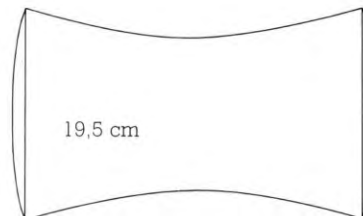

BC-14-385

25 mm \varnothing
Head
cabeza
tete

260 gr.
Weight
peso
poids



30 mm \varnothing
Head
cabeza
tete

300 gr.
Weight
peso
poids

Cottle
BC-14-386
19 cm
plan / konvex
plane / convex
plano / convexo
plan / convexe
plano / convesso



BC-14-390
Spare facing (pair)
Tapas de repuesto (par)
Plaques de rechange (paire)

Plastic
Plastico
Matiere plastique

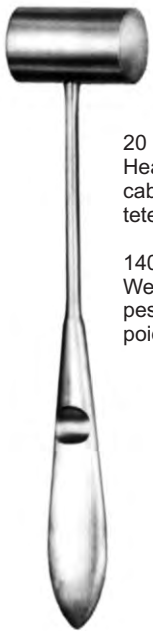

20 mm \varnothing
Head
cabeza
tete

140 gr.
Weight
peso
poids

Williger
BC-14-387
16.5 cm



30 mm \varnothing
Head
cabeza
tete

510 gr.
Weight
peso
poids

BC-14-388
26 cm
Plastic handle
mango de plastico
manche en matiere plastique

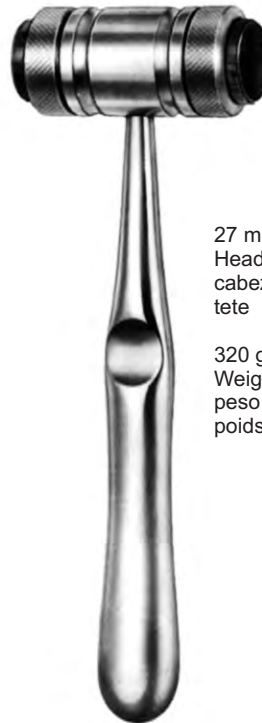

27 mm \varnothing
Head
cabeza
tete

320 gr.
Weight
peso
poids

Mead
BC-14-389
19 cm
with interchangeable plastic disks
con tapas intercambiables
avec plaques interchangeables



22 mm \varnothing
Head
cabeza
tete

200 gr.
Weight
peso
poids

Partsch
BC-14-391
19 cm
with hollow handle
con mango hueco
avec manche creux



42 mmø
Head
cabeza
tete

400 gr.
Weight
peso
poids

BC-14-392
26 cm
made of plastic
with lead filling
de plastico con
relleno de plomo
en matiere plastique
remplissage de plomb



42 mmø
Head
cabeza
tete

250 gr.
Weight
peso
poids

BC-14-393
26 cm
made of plastic
without lead
de plastico con
sin plomo
en matiere plastique
sans plomb



30 mmø
Head
cabeza
tete

675 gr.
Weight
peso
poids

BC-14-395
26.5 cm
plane (nylon) / convex (steel)
plastic handle
plano (nilon) / convexo (acero)
mango de plastico
plan (Nylon) / convexe (acier)
manche en matiere plastique



BC-14-399
Spare Facing (pair) Plastic
Tapas de repuesto (par) plastico
Plaques de rechange (paire) matiere plastique



42 / 30 mm ø
head
cabeza
tete

530 gr.
Weight
peso
poids

BC-14-396
26 cm
Plastic handle
mango de plastico
Manche en matiere plastique



30 mm ø
head
cabeza
tete

480 gr.
Weight
peso
poids

BC-14-397
24 cm
Plastic handle
mango de plastico
Manche en matiere plastique



37 mm ø
head
cabeza
tete

370 gr.
Weight
peso
poids

BC-14-398
24 cm
disks and handle of plastic
mango y tapas de plastico
manche et plaques en matiere plastique



30 mm ø
head
cabeza
tete

125 gr.
Weight
peso
poids

BC-14-400
22 cm
made of of plastic
de plastico
en matiere plastique



30 mm \varnothing
head
cabeza
tete

450 gr.
Weight
peso
poids

BC-14-401
26.5 cm
plastic handle
mango de plastico
manche en matiere plastique



50 mm \varnothing
head
cabeza
tete

900 gr.
Weight
peso
poids

BC-14-402
26.5 cm
plastic handle
mango de plastico
manche en matiere plastique



25 mm \varnothing
head
cabeza
tete

300 gr.
Weight
peso
poids

Vickers
BC-14-403
19 cm
nylon disks plastic handle
tapas de nilon mango de plastico
plaque en nylon manche en
matiere plastique



House
BC-14-404
15.5 cm



House
BC-14-405
15 cm



Martini
14 cm



BC-14-406 **BC-14-407** **BC-14-408**

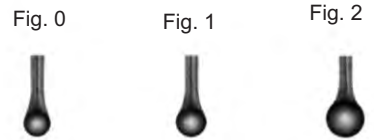

Williger
14 cm

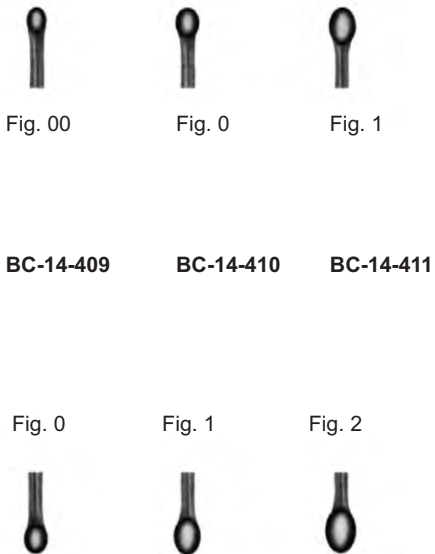

BC-14-409 **BC-14-410** **BC-14-411**

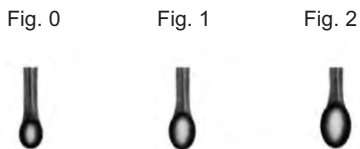

Williger
16 cm



BC-14-412 **BC-14-413** **BC-14-414**





Barth
BC-14-415
18 cm



Jansen
BC-14-416
16 cm



Jansen
BC-14-417
15.5 cm



BC-14-418
21 cm



Hemingway
16.5 cm



Fig. 1



Fig. 2



Fig. 3

BC-14-419

Fig. 1



BC-14-420

Fig. 2



BC-14-421

Fig. 3



Lucas
16.5 cm



Fig. 1



Fig. 2



Fig. 3

BC-14-422

Fig. 1



BC-14-423

Fig. 2



BC-14-424

Fig. 3





Volkman
BC-14-425
12.5 cm



Volkman
BC-14-426
16.5 cm



Volkman
BC-14-427
20.5 cm



Volkman
BC-14-428
13 cm



Volkman
BC-14-429
16.5 cm



Volkman
BC-14-430
20 cm



Williger
17.5 cm



Fig. 00
BC-14-431



Fig. 0
BC-14-432



Fig. 00
BC-14-435



Fig. 0
BC-14-436



Fig. 1
BC-14-433



Fig. 2
BC-14-434



Fig. 1
BC-14-437



Fig. 2
BC-14-438



Williger
17.5 cm



Uffenorde
BC-14-439
17 cm



Uffenorde
BC-14-440
17 cm



Mod. USA
16 cm

Fig.1
BC-14-441

Fig.2
BC-14-442

Fig.3
BC-14-443

Fig.4
BC-14-444

Fig.5
BC-14-445

Fig.6
BC-14-446



Mod. USA
15.5 cm

Fig.1
BC-14-447

Fig.2
BC-14-448

Fig.3
BC-14-449

Fig.4
BC-14-450

Fig.5
BC-14-451

Fig.6
BC-14-452



Mod. USA
15.5 cm

Fig.1
BC-14-453

Fig.2
BC-14-454

Fig.3
BC-14-455

Fig.4
BC-14-456

Fig.5
BC-14-457

Fig.6
BC-14-458

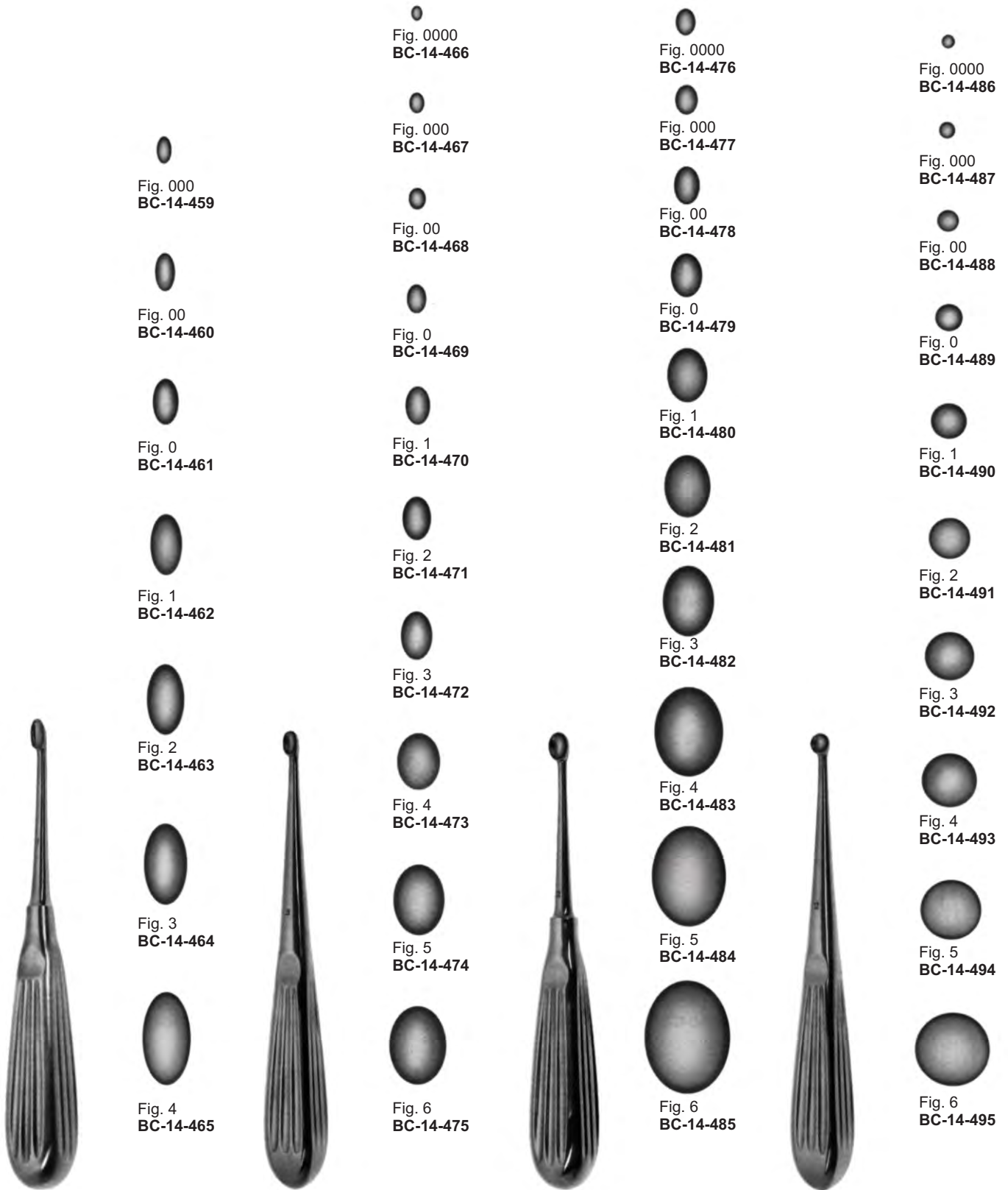

Schede
17.5 cm

Spratt
17 cm

Volkmann
17 cm

Bruns
17 cm



Fig. 000
BC-14-496



Fig. 00
BC-14-497



Fig. 0
BC-14-498



Fig. 1
BC-14-499



Fig. 2
BC-14-500



Fig. 3
BC-14-501



Fig. 4
BC-14-502



Fig. 5
BC-14-503



Fig. 6
BC-14-504



Bruns
23 cm



Fig. 000
BC-14-505



Fig. 00
BC-14-506



Fig. 0
BC-14-507



Fig. 1
BC-14-508



Fig. 2
BC-14-509



Fig. 3
BC-14-510



Fig. 4
BC-14-511



Fig. 5
BC-14-512



Fig. 6
BC-14-513



Bruns
22.5 cm



Fig. 000
BC-14-514



Fig. 00
BC-14-515



Fig. 0
BC-14-516



Fig. 1
BC-14-517



Fig. 2
BC-14-518



Fig. 3
BC-14-519



Fig. 4
BC-14-520



Fig. 5
BC-14-521



Fig. 6
BC-14-522



Bruns
23 cm



Fig. 00000
BC-14-523

Fig. 000
BC-14-525

Fig. 0
BC-14-527

Lempert
20.5 cm



Fig. 0000
BC-14-524



Fig. 00
BC-14-526



Fig. 1
BC-14-528



Malleable
maleable
malleable

Halle
21 cm



Fig. 1
BC-14-529



Fig. 2
BC-14-530



Fig. 3
BC-14-531



Daubenspeck
BC-14-532
19.5 cm



25 cm

Fig. 000
BC-14-533

Fig. 00
BC-14-534

Fig. 0
BC-14-535

Fig. 1
BC-14-536



25 cm

Fig. 000
BC-14-537

Fig. 00
BC-14-538

Fig. 0
BC-14-539

Fig. 1
BC-14-540



25 cm

Fig. 000
BC-14-541

Fig. 00
BC-14-542

Fig. 0
BC-14-543

Fig. 1
BC-14-544

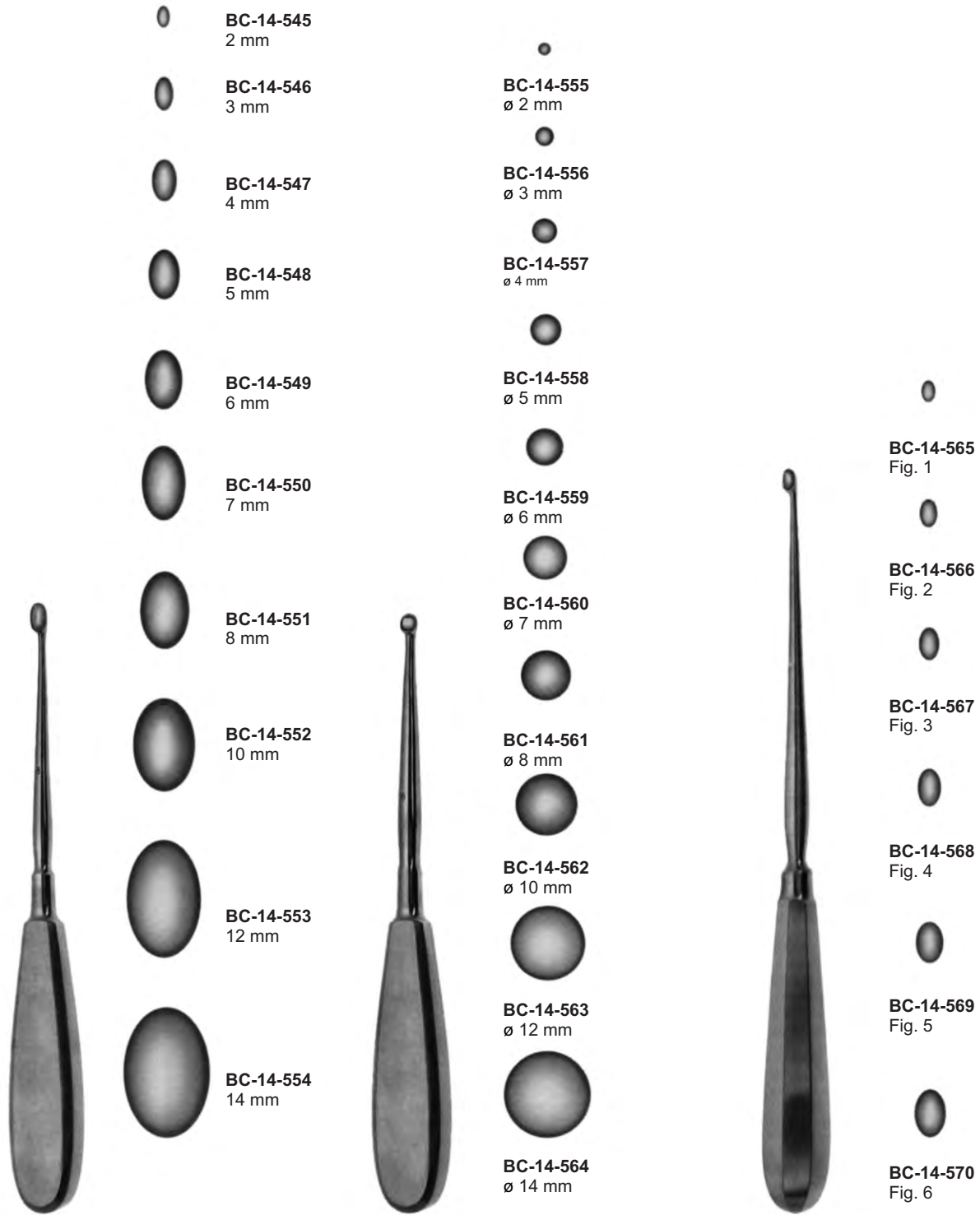

18 - 22 cm
Swedish pattern
modelos sueco
modeles suedois

17 - 20 cm
Swedish pattern
modelos sueco
modeles suedois

Simon
24 cm

Fig. 0000
BC-14-571

Fig. 000
BC-14-572

Fig. 00
BC-14-573

Fig. 0
BC-14-574

Fig. 1
BC-14-575

Fig. 2
BC-14-576

Fig. 3
BC-14-577

Fig. 4
BC-14-578

Fig. 5
BC-14-579

Fig. 6
BC-14-580



Fig. 0000
BC-14-581

Fig. 000
BC-14-582

Fig. 00
BC-14-583

Fig. 0
BC-14-584

Fig. 1
BC-14-585

Fig. 2
BC-14-586

Fig. 3
BC-14-587

Fig. 4
BC-14-588

Fig. 5
BC-14-589

Fig. 6
BC-14-590



BC-14-600
ø 2 mm

BC-14-601
ø 3 mm

BC-14-602
ø 4 mm

BC-14-603
ø 5 mm



BC-14-604
ø 6 mm

BC-14-605
ø 8 mm

BC-14-606
ø 10 mm



Can be autoclaved at 3 bar overpressure (143°C)
Esterilizables en autoclave a 3 bar sobrepresion (143°)
Sterilisables a l' autoclave a 3 bars (143°C)

16 cm
Tampers
Pison
Chasse-Greffons



BC-14-607
ø 3 mm



BC-14-608
ø 5 mm



BC-14-609
ø 8 mm



BC-14-610
ø 12 mm



BC-14-611
ø 14 mm



BC-14-612
ø 16 mm



000
BC-14-591



3
BC-14-596



00
BC-14-592



4
BC-14-597



0
BC-14-593



5
BC-14-598



1
BC-14-594



6
BC-14-599



2
BC-14-595



Volkman
17.5 cm
Bone currettes with handle from artificial wood
Cucharillas cortantes con mango de maderas artificial
Currettes avec manche en "Ferrozell"

Volkman
28 cm
Bone currettes with handle from artificial wood
Cucharillas cortantes con mango de maderas artificial
Currettes avec manche en "Ferrozell"

Cobb
28 cm

20 cm
Tampers with handle from artificial wood
Pison con mango de maderas artificial
Chasse-Freffons avec manche en "Ferrozell"



115 mm

Langenbeck
BC-14-615
23.5 cm

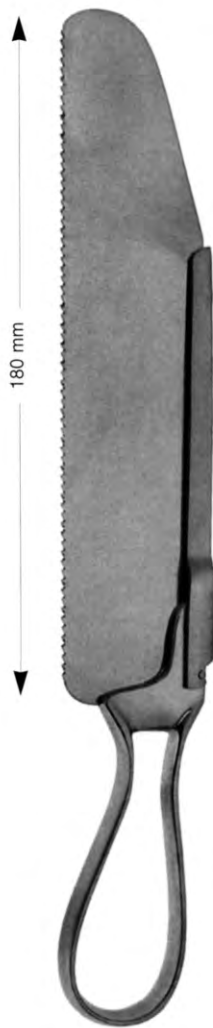

180 mm

Charriere
BC-14-616
27 cm

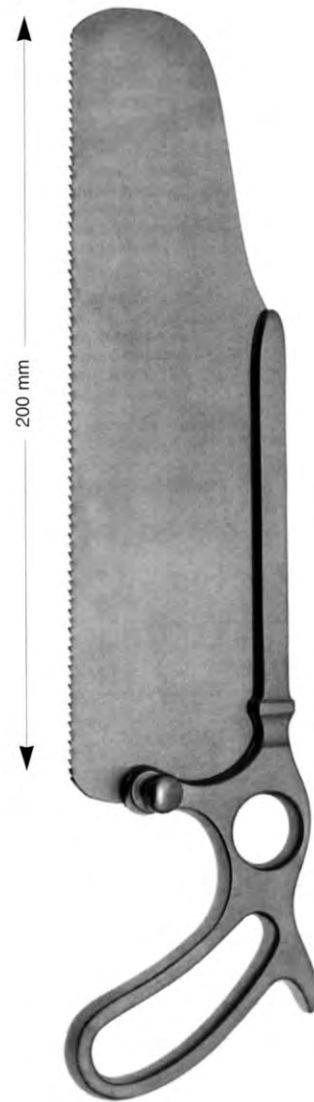

200 mm

Satterlee
BC-14-617
29 cm
With interchangeable saw blade (BC-14-568)
Con hoja de sierra intercambiable (BC-14-568)
avec lame interchangeable (BC-14-568)



Charrier
BC-14-618
35 cm
with 1 each interchangeable saw blade
12 mm (BC-14-570) and 18 mm (BC-14-571)

Con be hojas de sierras intercambiables
12 mm (BC-14-570) y 18 mm (BC-14-571)

avec 1 jeu de 2 lames de scie 12 mm
(BC-14-570) et 18 mm (BC-14-571)



Bier
BC-14-619
40.5 cm
with 1 each interchangeable saw blade
4 mm (BC-14-573), 6 mm (BC-14-574)
and 8 mm (BC-14-575)

Con 3 hojas de sierras intercambiables
4 mm (BC-14-573), 6 mm (BC-14-574) y 8 mm
(BC-14-575)

avec 1 jeu de 4 lames de scies 4 mm
(BC-14-573), 6 mm (BC-14-574) et 8 mm
(BC-14-575)

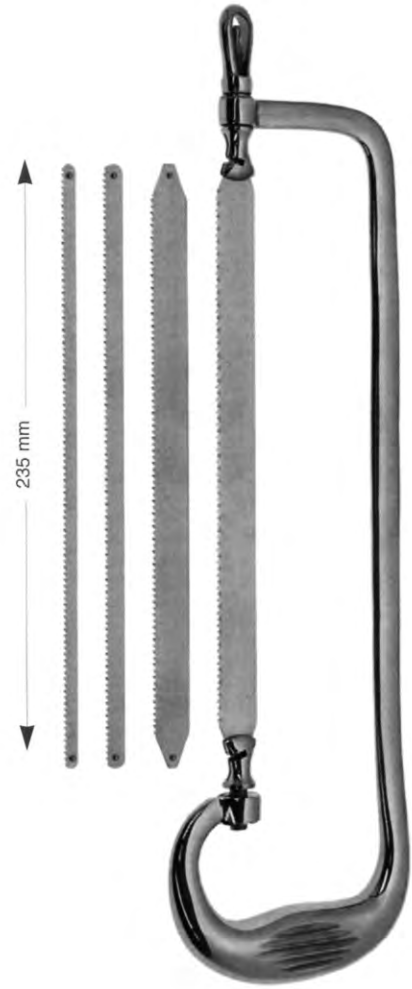

Rust
BC-14-620
39 cm
with 1 each interchangeable saw blade
6 mm (BC-14-578), 15 mm (BC-14-579)
and 18 mm (BC-14-580)

Con 4 hojas de sierras intercambiables
6 mm (BC-14-577), 8 mm (BC-14-578) y
15 mm (BC-14-579) y 18 mm (BC-14-580)

avec 1 jeu de 4 lames de scies 6 mm
(BC-14-577), 8 mm (BC-14-578),
15 mm (BC-14-579) et 18 mm (BC-14-580)

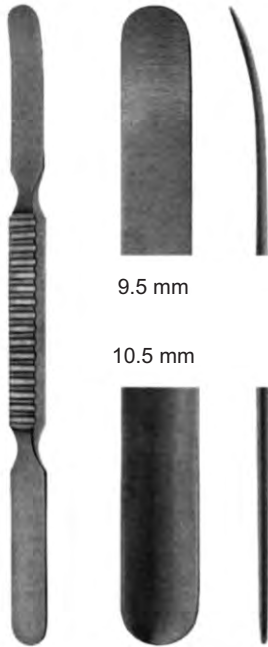

9.5 mm

10.5 mm

Watson-Cheyne
BC-14-621
17.5 cm

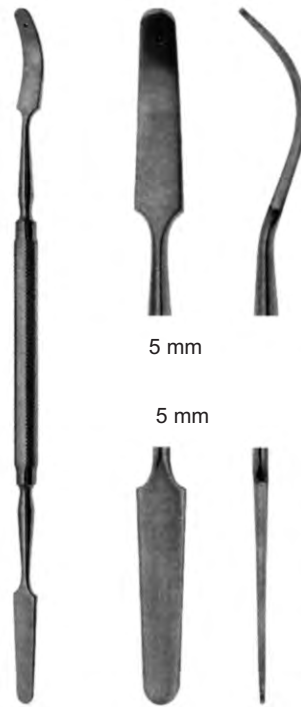

5 mm

5 mm

Mc Donald
BC-14-622
19 cm

Dissectors Disecadores Dissecteurs

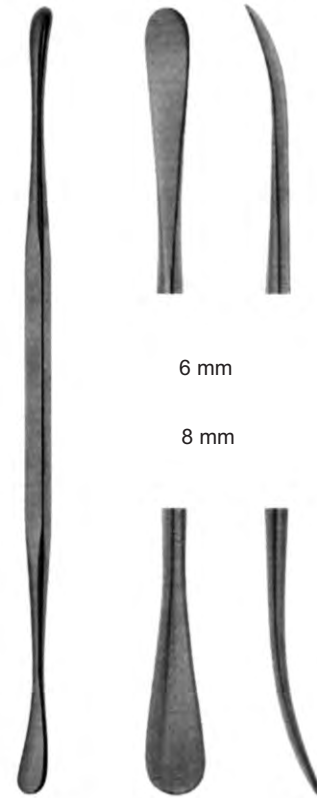

6 mm

8 mm

Alderdyce
BC-14-623
21.5 cm

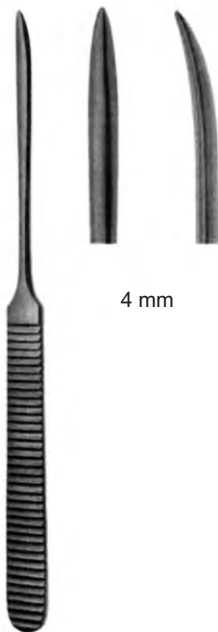

4 mm

Williger
BC-14-624
17 cm

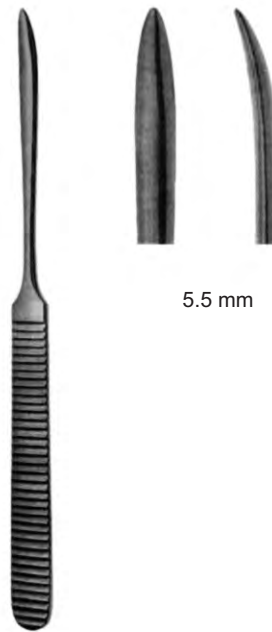

5.5 mm

Williger
BC-14-625
17 cm



5.5 mm

BC-14-626
16.5 cm

Elevators Elevadores Elevateurs

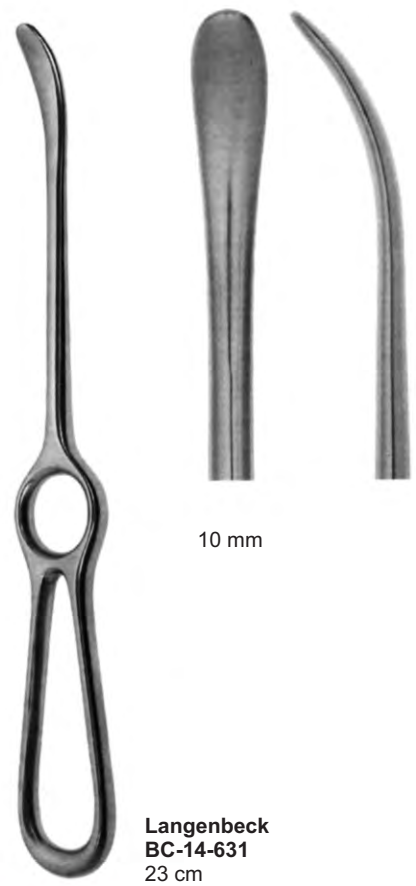
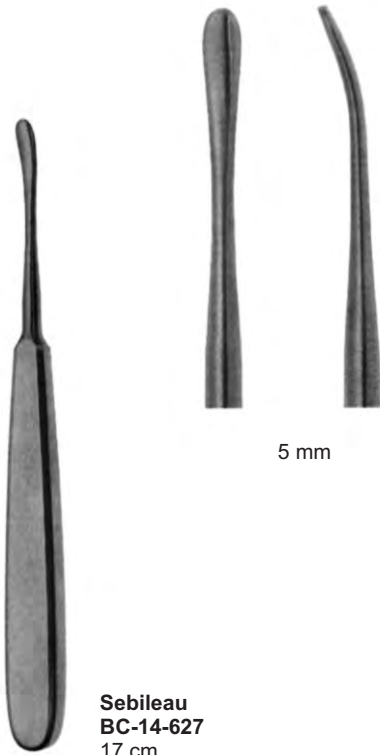

3 mm



BC-14-632
14.5 cm

6 mm



BC-14-633
14.5 cm

7 mm



BC-14-634
15 cm

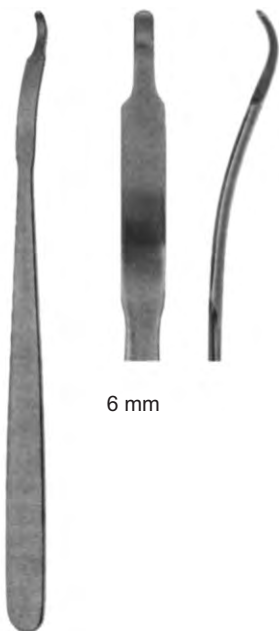

6 mm

Mini-Hohmann
BC-14-635
16 cm

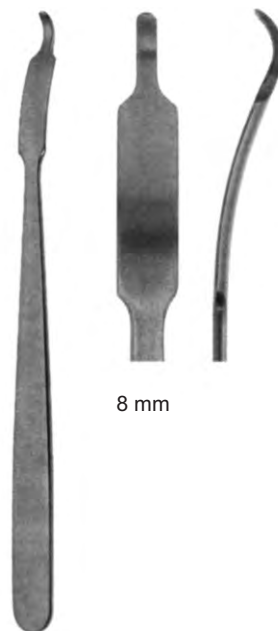

8 mm

Mini-Hohmann
BC-14-636
16 cm

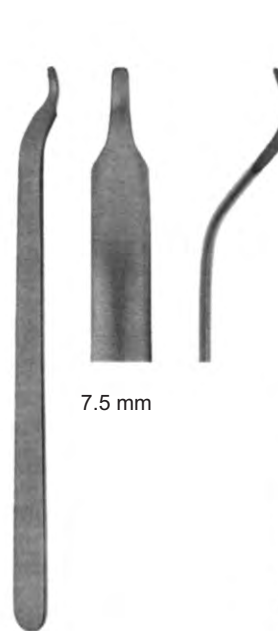

7.5 mm

Buck-Gramcko
BC-14-637
15 cm



16 mm

BC-14-638
12 cm



17 mm



24 mm



30 mm



Wagner
BC-14-639
22 cm



Lange-Hohmann
BC-14-640
25.5 cm



Lange-Hohmann modif.
BC-14-641
26.5 cm



9 mm



18 mm



18 mm



24 mm



**Hohmann
BC-14-642**
22 cm



**Hohmann
BC-14-643**
24 cm



**Hohmann
BC-14-644**
25.5 cm



**Hohmann
BC-14-645**
26 cm



35 mm



43 mm



64 mm



Hohmann
BC-14-646
28.5 cm



Verbrugge-Muller
BC-14-647
24 cm



Verbrugge-Muller
BC-14-648
25.5 cm



25 mm



24 mm



34 mm



45 mm



25 mm

**Hohmann
BC-14-649**
27 cm
Bone lever
elevador para hueso
Levier a' os



**Hohmann-Aldinger
BC-14-650**
28.5 cm
Bone lever
elevador para hueso
Levier a' os

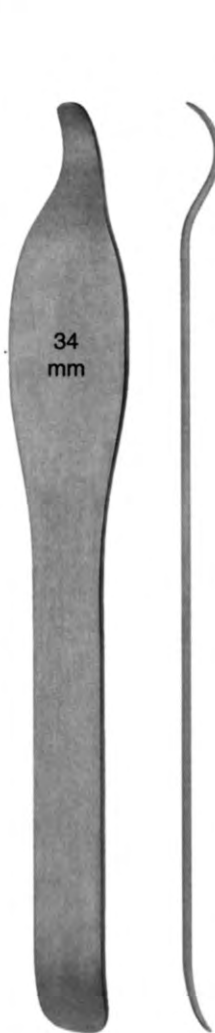

34 mm

**Blount
BC-14-651**
26 cm
Hib lever
elevador para cadera
eleveur pour la hanche



**Blount
BC-14-652**
26 cm
Hib lever
elevador para cadera
eleveur pour la hanche



BC-14-653
45 mm

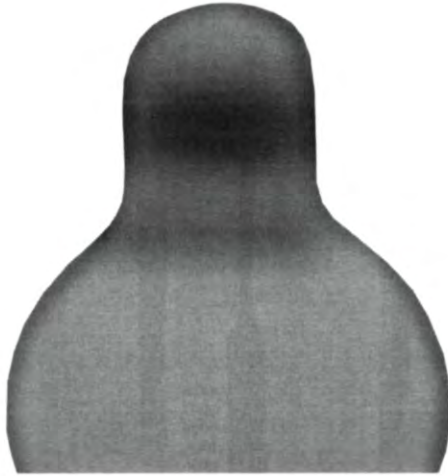

BC-14-654
60 mm



30 mm



18 mm



Bennet

25 cm
Bone levers
Elevadores para huesos
Leviers a' os



30 mm



18 mm

Murphy-Lane
BC-14-655

30 cm
Luxation lever
Elevador para luxacion
Levier pour luxation



Mc Kenty
 BC-14-656
 14.5 cm



Konig
 BC-14-657
 15.5 cm



Willger
 BC-14-658
 14 cm



Willger
 BC-14-659
 16 cm



Trelat
 BC-14-660
 15 cm



Joseph
 BC-14-661
 17 cm



Halle
 BC-14-662
 18 cm



Sewall
 BC-14-663
 20 cm

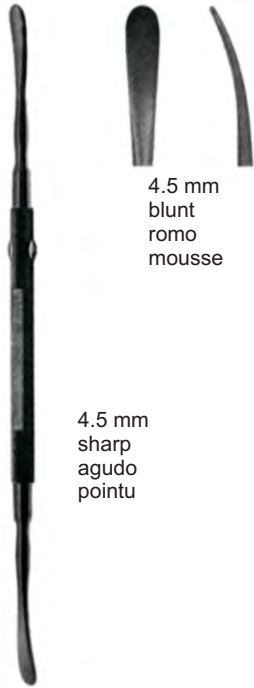

4.5 mm
blunt
romo
mousse

4.5 mm
sharp
agudo
pointu

**Freer
BC-14-664**
19.5 cm

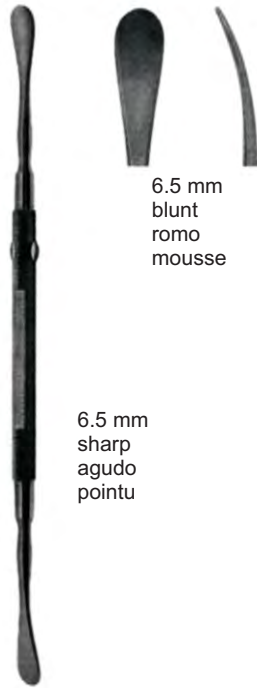

6.5 mm
blunt
romo
mousse

6.5 mm
sharp
agudo
pointu

**Freer
BC-14-665**
19.5 cm



4.5 mm
blunt
romo
mousse

**Freer
BC-14-666**
19.5 cm



4.5 mm
sharp
agudo
pointu

**Freer
BC-14-667**
19.5 cm



3.5 mm
blunt
romo
mousse

3.5 mm
sharp
agudo
pointu

**Killian
BC-14-668**
18.5 cm

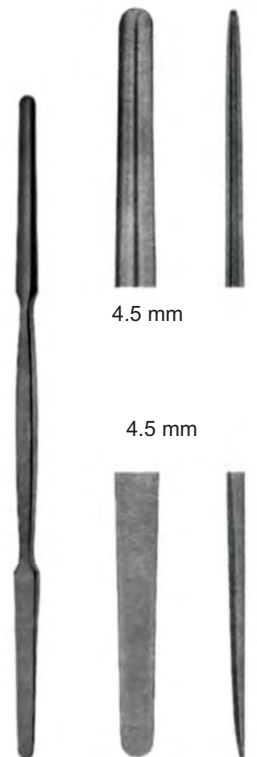

4.5 mm

4.5 mm

**Killian
BC-14-669**
19 cm

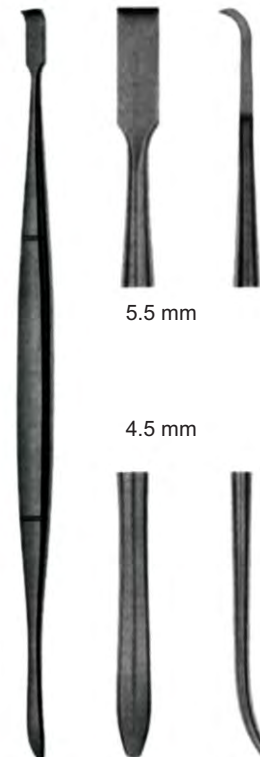

5.5 mm

4.5 mm

**Howard
BC-14-670**
21.5 cm

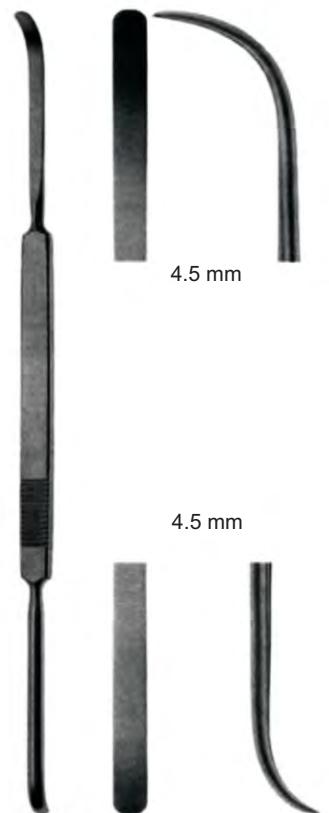

4.5 mm

4.5 mm

**Cottle
BC-14-671**
23 cm



17 cm



BC-14-672
6 mm



BC-14-673
8 mm



Lempert
17 cm



BC-14-674
2 mm



BC-14-675
3 mm



BC-14-676
4 mm



BC-14-677
5 mm



Muhling
17 cm



BC-14-678
4 mm



BC-14-679
4 mm



BC-14-680
4 mm



BC-14-681
6 mm



17 cm



BC-14-682
3 mm



BC-14-683
6 mm



Landolt
BC-14-684
17.5 cm



4.5 mm



Caspar
BC-14-685
18 cm



6 mm



Caspar
BC-14-686
18 cm



6 mm



Cottle
BC-14-687
19 cm



9 mm



Adson
 17 cm



BC-14-688
 8 mm



BC-14-689
 7 mm



BC-14-690
 7 mm



BC-14-691
 7 mm



Sedillot
BC-14-692
 19 cm

18 mm



Hoen
BC-14-693
 16 cm



6 mm



15 mm

Hoen
BC-14-694
 19 cm



20 mm

Hoen
BC-14-695
 19 cm



15 mm

Sedillot
BC-14-696
 22 cm



Jansen
BC-14-697
16.5 cm



Langenbeck
BC-14-698
19.5 cm



Langenbeck
BC-14-699
18 cm



Langenbeck
BC-14-700
19.5 cm



Langenbeck
BC-14-701
19.5 cm



Langenbeck
BC-14-702
19 cm



Langenbeck
BC-14-703
18 cm



Schneider
BC-14-704
17.5 cm



Schneider-Sauerbruch
BC-14-705
19 cm



Farabeuf
BC-14-706
15 cm



Farabeuf
BC-14-707
15 cm



Farabeuf-Collin
BC-14-708
15.5 cm



Farabeuf-Collin
BC-14-709
15.5 cm



3.0 mm

BC-14-710
17.5 cm



6.5 mm

BC-14-711
17.5 cm



9.5 mm

BC-14-712
19 cm



12.5 mm

BC-14-713
19 cm



16.0 mm

BC-14-714
20 cm



19.5 mm

BC-14-715
20 cm



24.5 mm

BC-14-716
21 cm



10.0 mm

BC-14-717
28.5 cm



13.0 mm

BC-14-718
28.5 cm



19.0 mm

BC-14-719
28.5 cm



25.0 mm

BC-14-720
28.5 cm



Key



Cobb



BC-14-721
19 cm



BC-14-722
19 cm



BC-14-723
19 cm



BC-14-724
19 cm



BC-14-725
19.5 cm



BC-14-726
20.5 cm



BC-14-727
20 cm



BC-14-728
20.5 cm



BC-14-729
10 mm



BC-14-730
13 mm



BC-14-731
19 mm



BC-14-732
25 mm



BC-14-733
27.5 cm



Wagner
33 cm



BC-14-734
8 mm



BC-14-735
17 mm

Can be autoclaved at 3 bar overpressure (143°)
Esterilizables en autoclave a 3 bar sobrepresion (143°)
Sterilisables a l' autoclave a 3 bara ((143°))

21 mm



Cobb
25 cm



Joseph
BC-14-736
 16.5 cm



Gallaher
BC-14-737
 17 cm



Lewis
 18 cm



BC-14-738
 fine
 fina
 denture fine



BC-14-739
 coarse
 gruesa
 denture grosse



Miller
 18 cm



BC-14-740



BC-14-741



BC-14-742





Maltz
BC-14-743
18 cm

Ø 3.5 mm



Cottle
BC-14-744
21 cm

Ø 3.5 mm



Aufricht
20.5 cm



BC-14-745
up stroke
a presion
a pousser



BC-14-746
down stroke
a traccion
a tirer



Wiener
BC-14-747
19.5 cm



Wiener
BC-14-748
19.5 cm



Brawley
BC-14-749
19.5 cm



Ø 3.7 mm

Watson-Williams
BC-14-750
22 cm



20 mm

18 mm

Putti
BC-14-751
27 cm



10 mm

16 mm

Putti
BC-14-752
30 cm



13 mm

BC-14-753
24.5 cm



20 mm

BC-14-754
28.5 cm

20 mm



BC-14-755
22 cm
file cut / rasp cut
filo de lima / filo de escofina
coupe lime / coupe rape



Fomon
21.5 cm
file cut / rasp cut
filo de lima / filo de escofina
coupe lime / coupe rape



BC-14-456
fine
fina
denture fine



BC-14-757
coarse
guesa
denture grosse





Hoke
BC-14-458 2 mm
BC-14-759 3 mm
BC-14-760 4 mm
BC-14-761 5 mm
BC-14-762 6 mm
BC-14-763 7 mm
BC-14-764 8 mm
 14 cm
 Osteotomes
 Oateotomos
 Osteotomes



Hoke
BC-14-465 2 mm
BC-14-766 3 mm
BC-14-767 4 mm
BC-14-768 5 mm
BC-14-769 6 mm
BC-14-770 7 mm
BC-14-771 8 mm
 14 cm
 Osteotomes
 Oateotomos
 Osteotomes

4 mm



Freer
BC-14-772
 17 cm
 Chisel
 Cincel
 Ciseaux-burins

4 mm



Freer
BC-14-773
 17 cm
 Chisel
 Cincel
 Ciseaux-burins

4 mm



West
BC-14-774
 16 cm
 Chisel
 Cincel
 Ciseaux-burins

4 mm



West
BC-14-775
 16 cm
 Gouge
 Gubia
 Gouges

6 mm



West
BC-14-776
 19 cm
 Chisel
 Cincel
 Ciseaux-burins

6 mm



West
BC-14-777
 19 cm
 Gouge
 Gubia
 Gouges



Cottle
BC-14-778 4 mm
BC-14-779 6 mm
BC-14-780 8 mm
BC-14-781 10 mm
BC-14-782 12 mm
18 cm
with depth markings
graduado
gradue

6 mm



Cottle
BC-14-783
18 cm
with depth markings
graduado
gradue



Mini-Lambotte
BC-14-784 2 mm
BC-14-785 3 mm
BC-14-786 4 mm
BC-14-787 6 mm
BC-14-788 8 mm
BC-14-789 10 mm
BC-14-790 12 mm
BC-14-791 15 mm
12.5 cm



Mini-Lambotte
BC-14-792 2 mm
BC-14-793 3 mm
BC-14-794 4 mm
BC-14-795 6 mm
BC-14-796 8 mm
BC-14-797 10 mm
BC-14-798 12 mm
BC-14-799 15 mm
17 cm



Lambotte
BC-14-800 4 mm
BC-14-801 6 mm
BC-14-802 8 mm
BC-14-803 10 mm
BC-14-804 13 mm
BC-14-805 15 mm
BC-14-806 10 mm
BC-14-807 20 mm
BC-14-808 25 mm
BC-14-809 30 mm
BC-14-810 38 mm
BC-14-811 44 mm
BC-14-812 50 mm
24 cm



Lambotte
BC-14-813 4 mm
BC-14-814 6 mm
BC-14-815 8 mm
BC-14-816 10 mm
BC-14-817 13 mm
BC-14-818 15 mm
BC-14-819 18 mm
BC-14-820 20 mm
BC-14-821 25 mm
BC-14-822 30 mm
BC-14-823 38 mm
BC-14-824 44 mm
BC-14-825 50 mm
24 cm



BC-14-826 4 mm
BC-14-827 6 mm
BC-14-828 8 mm
BC-14-829 10 mm
BC-14-830 12 mm
 13.5 cm
 Osteotomes
 Osteotomos
 Osteotomes



BC-14-831 4 mm
BC-14-832 6 mm
BC-14-833 8 mm
BC-14-834 10 mm
BC-14-835 12 mm
 13.5 cm
 Chisels
 Cinceles
 Ciseaux-burins



BC-14-836 4 mm
BC-14-837 6 mm
BC-14-838 8 mm
BC-14-839 10 mm
BC-14-840 12 mm
 13.5 cm
 Gouges
 Gubias
 Gouges



Alexander
BC-14-841 4 mm
BC-14-842 6 mm
BC-14-843 8 mm
BC-14-844 10 mm
BC-14-845 12 mm
 17.5 cm
 Osteotomes
 Osteotomos
 Osteotomes



Alexander
BC-14-846 4 mm
BC-14-847 6 mm
BC-14-848 8 mm
BC-14-849 10 mm
BC-14-850 12 mm
 17.5 cm
 Chisel
 Cinceles
 Ciseaux-burins



Alexander
BC-14-851 4 mm
BC-14-852 6 mm
BC-14-853 8 mm
BC-14-854 10 mm
BC-14-855 12 mm
 17.5 cm
 Gouges
 Gubias
 Gouges



Stille

- BC-14-856 10 mm
- BC-14-857 12 mm
- BC-14-858 15 mm
- BC-14-859 20 mm
- BC-14-860 25 mm

20.5 cm
Osteotomes
Osteotomos
Osteotomes

Stille

- BC-14-861 8 mm
- BC-14-862 10 mm
- BC-14-863 12 mm
- BC-14-864 15 mm
- BC-14-865 20 mm
- BC-14-866 25 mm
- BC-14-867 30 mm

20.5 cm
Osteotomes
Osteotomos
Osteotomes

Stille

- BC-14-868 10 mm
- BC-14-869 12 mm
- BC-14-870 15 mm
- BC-14-871 20 mm
- BC-14-872 25 mm

20.5 cm
Chisels
Cinceles
Ciseaux-burins

Stille

- BC-14-873 10 mm
- BC-14-874 12 mm
- BC-14-875 15 mm
- BC-14-876 20 mm
- BC-14-877 25 mm

20.5 cm
Gouges
Gubias
Gouges



Can be autoclave at 3 bar overpressure (143°C)
 Esterilizables en autoclave a 3 bar sobrepresion (143°C)
 Sterilisables a l' autoclave a 3 bars (143°C)

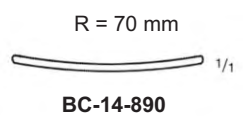
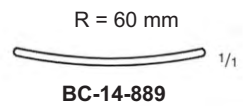
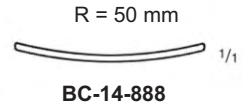

BC-14-879



BC-14-878 18.5 cm
 Handle or interchangeable blades,
 with key (BC-14-841)
 Mango para hojas intercambiables,
 con llave (BC-14-841)
 Manche pour lames interchangeables
 avec clef (BC-14-841)

BC-14-880 5 mm
BC-14-881 10 mm
BC-14-882 16 mm
BC-14-883 25 mm
 Interchangeable osteotome blades
 Osteotomos, hoja intercambiable
 Lames-osteotomes interchangeables

BC-14-884 5 mm
BC-14-885 10 mm
BC-14-886 16 mm
BC-14-887 25 mm
 Interchangeable chisel blades
 Cinceles, hojas intercambiable
 Lames-ciseaux-burins interchangeables

BC-14-888 25 mm (r= 50 mm)
BC-14-889 25 mm (r= 60 mm)
BC-14-890 25 mm (r= 70 mm)
 Interchangeable gouges blades
 Gubias, hojas intercambiable
 Lames-gouges interchangeables



Lexer
BC-14-891 10 mm
BC-14-892 15 mm
27.5 cm
Osteotomes, angled
Osteotomos, acodados
Osteotomes, angules



Lexer
BC-14-893 10 mm
BC-14-894 15 mm
27.5 cm
Gouges, angled
Gubias, acodadas
Gouges, angules



BC-14-895 10 mm
BC-14-896 15 mm
16 cm
Chisels
Cinceles
Ciseaux-burins



BC-14-897 10 mm
BC-14-898 15 mm
BC-14-899 20 mm
20 cm
Chisels
Cinceles
Ciseaux-burins



BC-14-900 10 mm
BC-14-901 15 mm
BC-14-902 20 mm
20 cm
Chisels
Cinceles
Ciseaux-burins

Can be autoclave at 3 bar overpressure (143°C)
 Esterilizables en autoclave a 3 bar sobrepresion (143°C)
 Sterilisables a l' autoclave a 3 bars (143°C)



Mini-Lexer
BC-14-903 4 mm
BC-14-904 6 mm
BC-14-905 8 mm
BC-14-906 10 mm
BC-14-907 12 mm
 18 cm
 Osteotomes
 Osteotomos
 Osteotomes



Mini-Lexer
BC-14-908 4 mm
BC-14-909 6 mm
BC-14-910 8 mm
BC-14-911 10 mm
BC-14-912 12 mm
 18 cm
 Gouges
 Gubias
 Gouges



Lexer
BC-14-913 5 mm
BC-14-914 7 mm
BC-14-915 10 mm
BC-14-916 15 mm
BC-14-917 20 mm
BC-14-918 25 mm
BC-14-919 30 mm
 22 cm
 Osteotomes
 Osteotomos
 Osteotomes



Lexer
BC-14-920 5 mm
BC-14-921 7 mm
BC-14-922 10 mm
BC-14-923 15 mm
BC-14-924 20 mm
BC-14-925 25 mm
BC-14-926 30 mm
 22 cm
 Gouges
 Gubias
 Gouges

Can be autoclave at 3 bar overpressure (143°C)
Esterilizables en autoclave a 3 bar sobrepresion (143°C)
Sterilisables a l' autoclave a 3 bars (143°C)



BC-14-927
24.5 cm
Chisel
Cinzel
Ciseaux-burins

BC-14-928
26.5 cm
Chisel
Cinzel
Ciseaux-burins

BC-14-929
22 cm
Gouge for removing
broken screw
Gubias para exteriorizar
tornillos truncados
Gouge pour extraire
les vis cassees

Zielke
BC-14-930 5.5 mm
BC-14-931 9.0 mm
23 cm
Gouge for scoliosis
operations
Gubias para operaciones
scoliosis
Gouge pour scoliose



Can be autoclave at 3 bar overpressure (143°C)
Esterilizables enautoclave a 3 bar sobrepresion (143°C)
Sterilisables a l' autoclave a 3 bars (143°C)



BC-14-932 5 mm
BC-14-933 10 mm
BC-14-934 15 mm
25 cm
Spongiosa gouges
Gubias de esponjosa
Ciseaux-burins spongiose



BC-14-935 5 mm
BC-14-936 10 mm
BC-14-937 15 mm
25 cm
Spongiosa gouges
Gubias de esponjosa
Ciseaux-burins spongiose



Lexer
BC-14-938 7 mm
BC-14-939 10 mm
28.5 cm
Spongiosa gouges
Gubias de esponjosa
Ciseaux-burins spongiose



**WELMED Instrument Company
Defence Road, Near Wapda Grid Station
Sialkot 51310, Pakistan.**

Phone : +92 52 3554782, 3558704

Fax : +92 52 3550296

📞 Mobile : +92 333 8680640

Email : welmedpk@gmail.com

info@welmedinst.com

wmm@brain.net.pk

welmed@cyber.net.pk

Website : www.welmedinst.com