



# Ophthalmology 19

**WELMED Instruments Company**  
Defence Road  
Near Wapda Grid Colony  
Sialkot 51310, Pakistan.

Phone : +92 52 3554782, 3558704  
Fax : +92 52 3550296  
Cell : +92 333 8680640

Email : [info@welmedinst.com](mailto:info@welmedinst.com)  
[welmedpk@gmail.com](mailto:welmedpk@gmail.com)  
[wmm@brain.net.pk](mailto:wmm@brain.net.pk)  
[welmed@cyber.net.pk](mailto:welmed@cyber.net.pk)

Website : [www.welmedinst.com](http://www.welmedinst.com)

## About Us

Quality begins at **WELMED** Instruments Company where master craftsmen forge and manufacture each instrument to its exact specifications and measurements. Instruments must undergo a series of quality control inspections in order to be worthy of **WELMED** name and warranty. We offer a wide selection of medical instruments including Surgical and Dental instruments.

We have acquired a unique and unmatched understanding of manufacturing through a large experience, working since 1908. Years of experience & state of the art manufacturing facilities helped us to keep our prices low. Our Surgical & Dental instruments are created by expert craftsmen, providing unfaltering quality you can rely on.

We have launched a fully interactive website where you can get online and track your orders 24 hours a day, 7 days in a week, and 365 days a year. Ask for our free e-catalogue on CD-Rom to save time and enjoy hassle free ordering.

We provide our customers with most reliable customer service as your satisfaction is our top priority. Our customers always enjoy our wonderful customer service and quality tools at the best price.

Lastly we invite you to have a work experience with **WELMED** Instruments Company and we will prove ourselves as one of the most valuable source you have.

You can find us at

**WELMED Instruments Company**  
Defence Road, Near Wapda Grid Colony  
Sialkot 51310, Pakistan.

Phone : +92 52 3554782, 3558704  
Fax : +92 52 3550296  
Cell : +92 333 8680640

Emails :  
Info@welmedinst.com  
welmedpk@gmail.com  
wmm@brain.net.pk  
welmed@cyber.net.pk

Website : [www.welmedinst.com](http://www.welmedinst.com)



## History

**WELMED Instruments Company** was founded in 1995. Our Great Grandfather **Mian Muhammad Fazal Elahi** was the founder of M/s M.F. Elahi & Company (E.P.) Pvt. Ltd, established in 1908. WELMED is a sister concern of M.F. Elahi & Co. It is our pride to be a member of M.F. Elahi Family.

WELMED Instruments Company is located in the heart of beautiful city, Sialkot, Pakistan. We are manufacturers and exporters of quality Surgical, Dental instruments and Scissors of all sorts in various categories. We are closely attached with highly skilled surgeons and other technicians of the surgical industry to make the new instruments development possible.

WELMED is in a continuous process of development and testing of new instruments for their precision and perfect functioning. We are also working at imported forging supply by foreign customers.

## Certificates

Welmed Instruments Company has achieved the certificates for ISO-9001, ISO-13485, cGMP (FDA) and CE Marking.

## Quality Control

All material use in the manufacturing of our instruments are tested from relevant laboratories. Our continuous quality control is our best warranty so that you built confidence in our products.

## Deliveries

Deliveries are quick and in-time.

## Mode Of Payment

Terms of Payment is ADVANCE or LETTER OF CREDIT (Irrevocable)

## Quality Policy

**WELMED Instruments Company** aims to produce quality Surgical, Dental instruments and Scissors of all sorts at reasonable prices to become an exemplary manufacturer. Our total emphasize is to achieve customer's satisfaction by clearly understanding their requirements and following a quality management system which is a primary concern of all our work force. We do our best to produce instruments of finest quality.



## Warranty

All WELMED Instruments are produced from finest stainless steel available to be free from any defect in material or workmanship. Any product that proves to be defective in material or workmanship will either be repaired or replaced without any charge. This warranty is void if the instrument is abused, altered, modified or is not used in the manner for which it is intended.

# Ophthalmology

## 19



**WELMED**  
INSTRUMENTS CO.

|  |                         |  |                         |
|--|-------------------------|--|-------------------------|
| Adjustable Wire                        | 92                      | Corneal Epithelium Spatulae                      | 93                      |
| Adventitia                             | 62,64                   | Critchett  | 12                      |
| Aebli                                  | 58                      | Culler   | 22,27                   |
| Agricola                               | 14                      | Curdy  | 80                      |
| Akahoshi Nucleus Sustainer             | 93                      | Daily  | 80                      |
| Alvis                                  | 81                      | Dastoor  | 50                      |
| Anderson-critchett                     | 80                      | Datzin-barraquer                                 | 58                      |
| Arlt                                   | 19,29                   | Daviel   | 19, 31                  |
| Arrowsmith                             | 70,71                   | De La Roza                                       | 69                      |
| Arruga                                 | 01,02,13,19,25,45       | Dermot Pierse (colibri)                          | 55                      |
| Arruga-elschnig                        | 45                      | Desmarres  | 15,67,79,80             |
| Axenfeld                               | 20,24,33,79             | Deutschmann                                      | 16                      |
| Ayer                                   | 67                      | Deutschmith-green                                | 75                      |
| Baird                                  | 67                      | Dilator Forcep                                   | 82                      |
| Bangerter                              | 27,52                   | Direct Action Lens Implantation                  | 90,91                   |
| Barkan                                 | 80                      | Dissection                                       | 62,64                   |
| Barraquer (colibri)                    | 12                      | Dix  | 21,81                   |
| Barraquer Modif.                       | 54                      | Elliot   | 38                      |
| Barraquer                              | 02,05,48,49,56,61,68,80 | Ellis  | 81                      |
| Barraquer-fino                         | 28                      | Elschnig   | 22,28,44,46,48,68,79,80 |
| Barraquer-katzin (colibri)             | 42                      | Fenzl Lens Manipulator                           | 93                      |
| Barraquer-katzin                       | 42                      | Fink   | 23                      |
| Barraquer-llovera                      | 48,68                   | Fink-jameson                                     | 52                      |
| Barraquer-troutman                     | 05                      | Fischer  | 38                      |
| Barrquer                               | 87                      | Fischer-artl                                     | 38                      |
| Becker                                 | 15                      | Foerster   | 36                      |
| Berens                                 | 18,52,53,75,76          | Foreign Body With Magnifier                      | 21                      |
| Berks                                  | 52                      | Francis  | 67,81                   |
| Binkhorst                              | 45                      | Fuchs  | 41,44                   |
| Bishop-harman                          | 39                      | Gass Muscle Hook                                 | 93                      |
| Blade Breaker                          | 87                      | Gill   | 41,79                   |
| Blascovics                             | 52                      | Gill-arruga                                      | 44                      |
| Bonaccolto                             | 50                      | Gill-hess  | 41                      |
| Bonn                                   | 40                      | Gills-welsch                                     | 60                      |
| Bores                                  | 69,70,71,73             | Graefe 11,12,15,17,18,19, 23, 25,31,36,37,47,74, | 75,77,78,79             |
| Bowman                                 | 11,12,77,81             | Graefe-arruga                                    | 74                      |
| Bunge                                  | 20                      | Green  | 18,25,35,48             |
| Burch                                  | 80                      | Gtaefe   | 19                      |
| Button Manipulator                     | 93                      | Guthrie  | 23,80                   |
| Capulorhexis Notched                   | 91                      | Guyton-lundsgaard                                | 80                      |
| Capulorhexis                           | 91                      | Haab   | 78                      |
| Castroviejo Corneal Scissor            | 85                      | Haefliger Phaco Cleaver                          | 93                      |
| Castroviejo Corneal                    | 86                      | Heath  | 33,67                   |
| Castroviejo 01,02,04,09,10,11,14,16,18 |                         | Hebra  | 32                      |
| 22,26,28,35,46,47,49,56,58,61,68,76,86 |                         | Hepp-schedel                                     | 03                      |
| Castroviejo-barraquer                  | 01, 22                  | Hess   | 19,31,38,44             |
| Castroviejo-colibri                    | 43                      | Hirschman  | 23                      |
| Castroviejo-schachar                   | 26                      | Hirschmann                                       | 17                      |
| Cauer                                  | 53                      | Hoffer   | 72                      |
| Chandler                               | 41                      | Hofmann-polack Corneal                           | 92                      |
| Clayman                                | 45                      | Hunt   | 67                      |
| Claymans Type Lol                      | 90                      | Iris Scissors                                    | 86                      |
| Colibri Suturing                       | 89                      | Incision Spreading Forcep                        | 73                      |
| Conjunctival                           | 85                      | Jaboma   | 03                      |
| Connin-amsler                          | 26                      | Jacobi   | 69                      |
| Connor Intracapsular Manipulator       | 94                      | Jacobson   | 09                      |
| Conway                                 | 15                      | Jaeger   | 11,25,75                |
| Cook                                   | 13                      |  |                         |



|                                |             |                             |          |
|--------------------------------|-------------|-----------------------------|----------|
| Jaffe-berchert                 | 30          | Minami "m" Hook             | 93       |
| Jaffe-blaydes                  | 90          | Mob. Barraquer              | 12       |
| Jaffe-knolle Lris Hook         | 94          | Mod. Bonn17,                | 17,39    |
| Jameson                        | 25,51       | Mod. Hamaburg               | 77       |
| Jeffe-knolle                   | 17          | Mod. Tubingen               | 17,54,77 |
| Jerger-griehaber               | 76          | Moorfield                   | 49       |
| Johnson                        | 78,80       | Mueller                     | 14       |
| Johnson-took                   | 79          | Murdock                     | 13       |
| Kalt                           | 46          | Needle Holder               | 03,84,87 |
| Kansas Nucleus Trisector       | 94          | Needle Holders Porta-agujas | 08-07    |
| Kansas Nucleus Vectis          | 93          | Needle                      | 21       |
| Katzin                         | 57          | Neuliann Nucleus Divider    | 94       |
| Katzin Barraquer               | 58          | Nicati                      | 81       |
| Kelman-mc Pherson              | 56,90       | Nichamin Phaco              | 93       |
| Kirby                          | 34          | Nightingale                 | 33       |
| Kirby-artur                    | 42          | Notched                     | 88       |
| Knapp                          | 19,23,31,77 | Noyes                       | 59       |
| Knapp-clark                    | 12          | Nugent                      | 50       |
| Knapp-rollet                   | 24          | O' Connor                   | 17, 38   |
| Knolle                         | 17          | Ong                         | 59       |
| Kremer                         | 70          | Papst                       | 76       |
| Kuhnt                          | 78          | Park Guyton                 | 13       |
| La Force (golf-club)           | 81          | Park                        | 13       |
| Lambert                        | 67          | Park-guyton                 | 11       |
| Lancaster                      | 11,12       | Park-maumenee               | 11,13    |
| Lang                           | 20,33       | Paton                       | 79       |
| Lens Implantation              | 90          | Paufique                    | 54       |
| Lens Loop                      | 94          | Phaco Claw Chopper          | 93       |
| Lens Nucleus Rotator           | 93          | Pierse-colibri Corneal      | 88       |
| Lester Lol Manipulator         | 94          | Plange                      | 81       |
| Lester48,                      | 48,68       | Pley                        | 12       |
| Levinson                       | 81          | Polack Corneal              | 92       |
| Lewicky Lens                   | 94          | Prince                      | 51       |
| Lewis                          | 19,29       | Razor Blade Holder          | 84       |
| Lieberman Lasik Solid Speculum | 92          | Reill                       | 06       |
| Lindner                        | 18,35       | Rollet                      | 23       |
| Lister-burch                   | 13          | Round, Hollow Handle Forcep | 82       |
| Lol Forceps                    | 90          | Rowland                     | 77       |
| Lordan                         | 53          | Rubman-bores                | 70       |
| Lris                           | 86          | Sato                        | 78       |
| Lundsgaaard                    | 80          | Sattler                     | 51       |
| Machat Lasik                   | 92          | Sauer Mob.martin            | 47       |
| Maumenee-colibri               | 43          | Sauer                       | 14       |
| Mc Cullough                    | 51          | Sautter                     | 26       |
| Mc Gannen18,                   | 18,23       | Scheie                      | 80       |
| Mc Pherson                     | 54,88,89    | Schmith-green               | 75       |
| Mc Pherson-westcott Stitch     | 85          | Schnaudigl                  | 77       |
| Mc Reynolds                    | 80          | Schweigger                  | 44       |
| Mellinger Beard                | 14          | Schweiz. Mod.               | 81       |
| Mellinger                      | 13          | Schwelgger                  | 81       |
| Mellinger-axenfeld             | 13          | Scissors                    | 83       |
| Mellinger-beard                | 11          | Searcy                      | 80       |
| Meyer-schwickerath             | 17          | Shepard li                  | 1145     |
| Meyhoefer Hebra Bunge          | 20          | Shepard                     | 45       |
| Meyhoefer                      | 20,32       | Sichel                      | 78       |
| Micro Scissor                  | 63,65,66    | Sinskey Lens Manipulating   | 94       |
| Microintraocular Forcep        | 83          | Sinskey                     | 30       |
| Microintraocular Scissor       | 83          | Sinskey-cornic              | 30       |

|                       |                |
|-----------------------|----------------|
| Smith-fisher          | 18,35          |
| Snellen               | 19,29,53       |
| St. Martin            | 49             |
| Stevens Needle Holder | 84             |
| Stevens               | 18,25,37       |
| Stevenson             | 14             |
| Stock                 | 22,27,44       |
| Suker                 | 22,27          |
| Suturing              | 89             |
| Swiss Pattern         | 46             |
| Synechiae Spatula     | 94             |
| Terson                | 44             |
| Thornton              | 71             |
| Took                  | 79             |
| Trouman               | 57             |
| Troutman (colibri)    | 42             |
| Troutman- Castroviejo | 56-58          |
| Troutman              | 06,19,29,49,87 |
| Tubingen              | 40             |
| Tying Forcep          | 88             |
| Vannas Mod. Tubingen  | 60             |
| Vannas                | 60,85,86       |
| Walker-lee            | 80             |
| Walton                | 81             |
| Weber                 | 19,29,77       |
| Wecker                | 22,27,59,76,79 |
| Weiss                 | 11,12,31       |
| Wessely-grieshaber    | 76             |
| Westcott Stitch       | 85             |
| Westcott Tenotomy     | 85             |
| Wheeler               | 16,18,35,75    |
| Wiener                | 17,18,76       |
| Wies                  | 67             |
| Willard-colibri       | 43             |
| Williams              | 13             |
| Wire Speculum         | 92             |
| Woodruff              | 69             |
| Ziegler               | 12,78          |





BC-19-101



BC-19-102

**Castroviejo**  
 14 cm / 5 1/4"



BC-19-103



BC-19-104

**Castroviejo**  
 14 cm / 5 1/4"



BC-19-105



BC-19-106

1/2

**Arruga**  
 16 cm / 6 1/4"



1/2



1/2

**Castroviejo**  
**BC-19-107**  
 13 cm / 5 1/4"



1/2



1/2

**Castroviejo-Barraquer**  
**BC-19-108**  
 12 cm / 5 3/4"



1/2

**Castroviejo**  
14 cm / 5 1/2"



**BC-19-109**



**BC-19-110**

Smooth



1/2

**Arruga**  
16 cm / 6 1/4"



**BC-19-111**



**BC-19-112**

Mini profile



1/2

**Castroviejo**  
**BC-19-113**  
13 cm / 5"



Smooth



1/2

**Barrquer**  
**BC-19-114**  
13 cm / 5"



Smooth



1/2

**Barrquer**  
**BC-19-115**  
13 cm / 5"



Smooth



**Webster**  
**BC-19-115-1**  
13 cm / 5"



**Crile-Wood**  
**BC-19-115-2**  
15 cm / 6"

Mini profile  
perfil mini  
profil mini

With automatic release ratchet also for lefthanders  
con cremallera automática también para zurdos  
avec cremallere automatique aussi pour gauchers

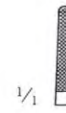

**BC-19-115-3**  
18 cm / 7"  
with lock  
con cierre  
avec serrure

Micro profile  
perfil micro  
profil micro



Jaboma



**BC-19-115-4**  
18 cm / 7"  
smooth jaw  
boca lisa  
mors lisse

Hepp-Scheidel



**BC-19-115-5**  
14.5 cm / 5¾"  
With lock  
con cierre  
avec serrure

Micro profile  
perfil micro  
profil micro



**BC-19-115-6**  
14.5 cm / 5¾"  
With lock  
con cierre  
avec serrure

Micro profile  
perfil micro  
profil micro



**BC-19-115-7**  
14.5 cm / 5¾"  
smooth jaw  
boca lisa  
mors lisse



**BC-19-115-8**  
18 cm / 7"  
With lock  
con cierre  
avec serrure

Micro profile  
perfil micro  
profil micro



**BC-19-115-9**  
21.5 cm / 8½"  
With lock  
con cierre  
avec serrure

Micro profile  
perfil micro  
profil micro



Castroviejo



**BC-19-115-10**  
14.5 cm / 5¾"  
smooth jaw  
boca lisa  
mors lisse



**BC-19-115-11**  
18 cm / 7"  
With lock  
con cierre  
avec serrure

Micro profile  
perfil micro  
profil micro



**BC-19-115-12**  
21.5 cm / 8½"  
With lock  
con cierre  
avec serrure

Micro profile  
perfil micro  
profil micro



**Barraquer-Troutman**  
**BC-19-116**  
 10 cm / 4"



**Barraquer-Troutman**  
**BC-19-117**  
 10 cm / 4"



**Barraquer-Troutman**  
**BC-19-118**  
 10 cm / 4"



**Barraquer-Troutman**  
**BC-19-119**  
 10 cm / 4"



**Barraquer**  
**BC-19-120**  
 11 cm / 4 1/4"



**Barraquer**  
**BC-19-121**  
 13 cm / 5"



**Barraquer**  
**BC-19-122**  
 14 cm / 5 1/2"



**Barraquer**  
**BC-19-123**  
 14 cm / 5 1/2"



**Barraquer**  
**BC-19-124**  
 14 cm / 5 1/2"



**Troutman**  
**BC-19-125**  
12 cm / 4¾"



**Troutman**  
**BC-19-126**  
12 cm / 2¾"



**BC-19-127**

**BC-19-128**

**Reill**  
15 cm / 6"



**BC-19-129**

**BC-19-130**

**Reill**  
15 cm / 6"



**BC-19-131**  
14 cm / 5 1/2"



**BC-19-132**  
14 cm / 5 1/2"  
for right handed surgeons

Jaws concave/convex



**BC-19-133**  
14 cm / 5 1/2"  
for left handed surgeons



**BC-19-134**  
18 cm / 7¼"



**BC-19-135**  
18 cm / 7¼"



**BC-19-136**  
18 cm / 7¼"



**BC-19-137**  
18 cm / 7¼"



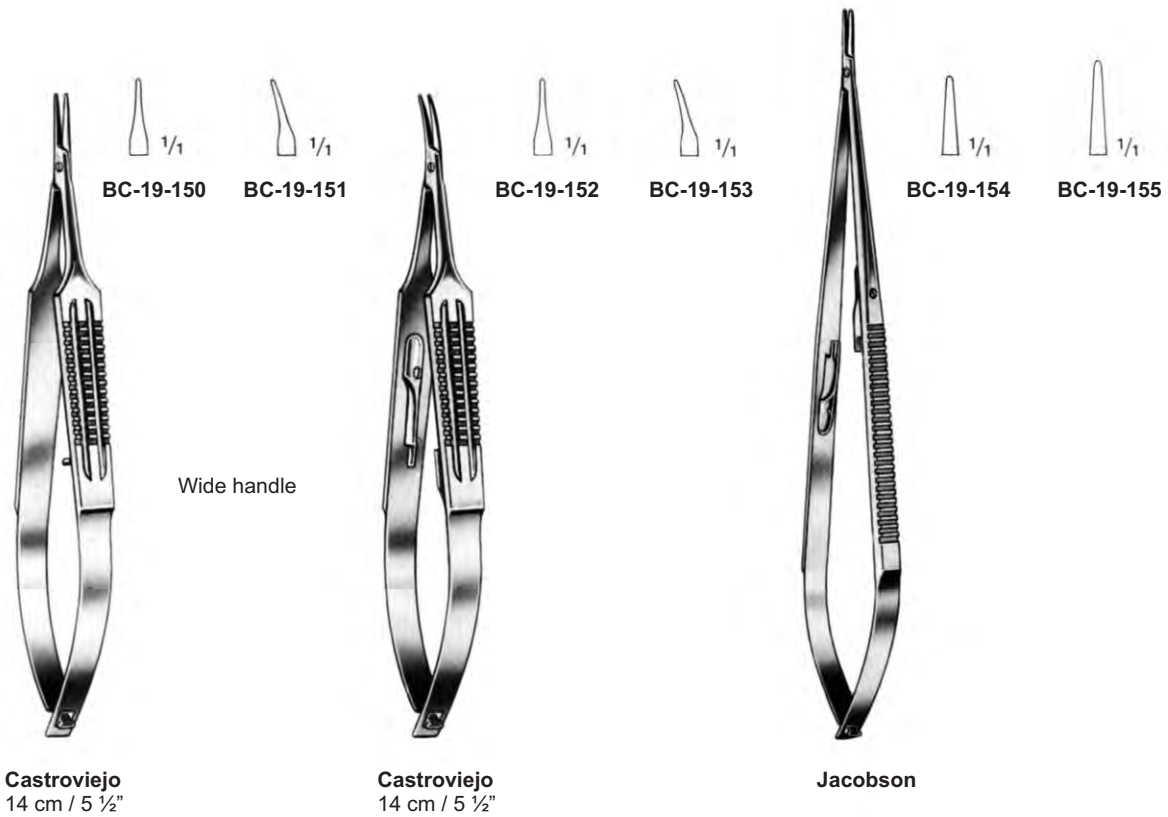
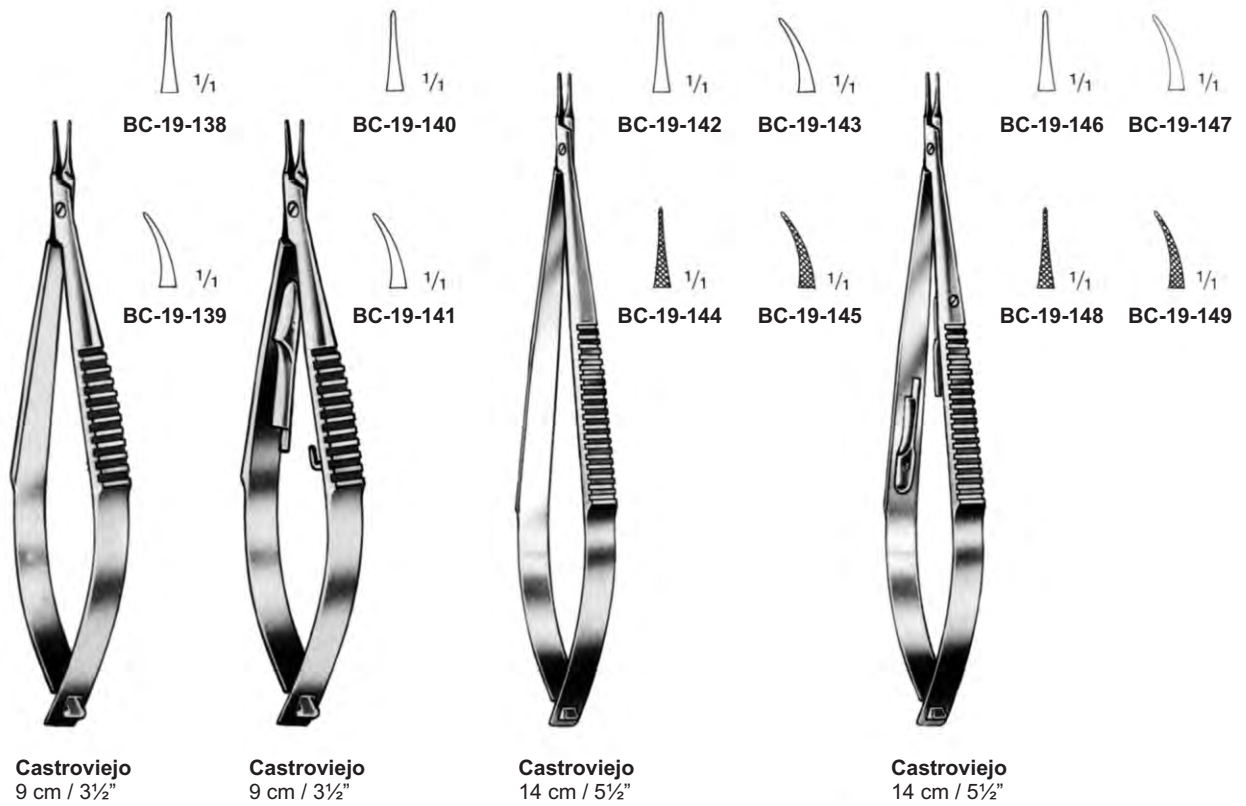



BC-19-156



BC-19-158



BC-19-160



BC-19-162



BC-19-157



BC-19-159



BC-19-161



BC-19-163



**Castroviejo**  
13 cm / 5 1/4"  
Handle 8 mm ø



**Castroviejo**  
13 cm / 5 1/4"  
Handle 8 mm ø



**Castroviejo**  
13 cm / 5 1/4"  
Handle 10 mm ø



**Castroviejo**  
13 cm / 5 1/4"  
Handle 10 mm ø

Eye Specula . Blefarostatos . Blépharostats



½

**Bowman**  
**BC-19-164**  
7 cm / 2¾"

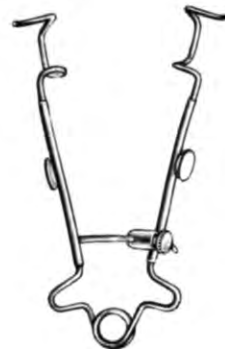

**Graefe**  
**BC-19-165**  
7 cm / 2¾"



½

**Weiss**  
**BC-19-166**  
8 cm / 3¼"



½

**Lancaster**  
**BC-19-167**  
8 cm / 3¼"



½

**Park-Guyton**  
**BC-19-168**  
8 cm / 3¼"



½

**Park-Maumenee**  
**BC-19-169**  
8 cm / 3¼"

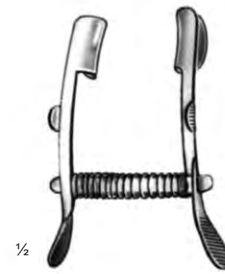

½

**Mellinger-Beard**  
**BC-19-170**  
5 cm / 2"  
**BC-19-171**  
7 cm / 2¾"



½

**Castroviejo**  
**BC-19-172**  
8 cm / 3¼"



½

**Jaeger**  
**BC-19-173**  
11 cm / 4½"

Lid Plate  
Placa para párpados  
Plaque a paupieres

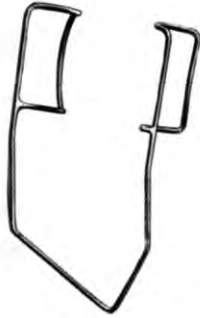

**Barraquer (Colibri)**  
**BC-19-174** 3 cm / 1¼"  
children



**Mod. Barraquer**  
**BC-19-176**  
4 cm / 1½"



**Bowman**  
**BC-19-177**  
7 cm / 2¾"

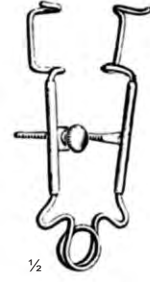

**Critchett**  
**BC-19-178**  
7 cm / 2¾"



**Graefe**  
**BC-19-179**  
7 cm / 2¾"  
Children



**Graefe**  
**BC-19-180**  
9 cm / 3½"  
adults

**Pley**  
**BC-19-181**  
6 cm / 2½"



**Ziegler**  
**BC-19-182**  
7 cm / 2¾"



**Knapp-Clark**  
**BC-19-183**  
8 cm / 3¼"



**Lancaster**  
**BC-19-184**  
8 cm / 3¼"



**Weiss**  
**BC-19-185**  
7 cm / 2¾"  
Children

**Weiss**  
**BC-19-186**  
9 cm / 3½"  
adults



**Weiss**  
**BC-19-187**  
7 cm / 2¾"  
Children

**Weiss**  
**BC-19-188**  
9 cm / 3½"  
adults



**Weiss**  
**BC-19-189**  
8 cm / 3¼"



1/2

**Lister-Burch**  
**BC-19-190**  
8 cm / 3 1/4"



**Williams**  
**BC-19-191**  
7 cm / 2 3/4"  
children

**Williams**  
**BC-19-192**  
8 cm / 3 1/4"  
adults



1/2

**Park**  
**BC-19-193**  
8 cm / 3 1/4"



1/2

**Park Guyton**  
**BC-19-194**  
8 cm / 3 1/4"



1/4

**Park-Maumenee**  
**BC-19-195**  
8 cm / 3 1/4"



1/2

**Arruga**  
**BC-19-196**  
7 cm / 2 3/4"  
for left eye

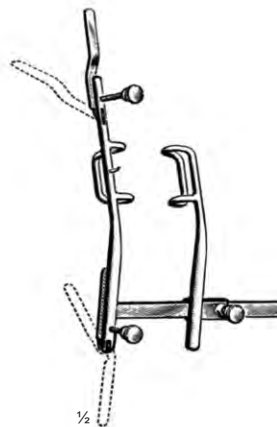

1/2

**Arruga**  
**BC-19-197**  
7 cm / 2 3/4"  
for right eye



1/2

**Murdock**  
**BC-19-198**  
5 cm / 2"



1/2

**Cook**  
**BC-19-199**  
4 cm / 1 1/2"  
children

**Cook**  
**BC-19-200**  
5 cm / 2"  
adults



1/2

**Mellinger**  
**BC-19-201**  
5 cm / 2"  
children

**Mellinger**  
**BC-19-202**  
7 cm / 2 3/4"  
adult



1/2

**Mellinger-Axenfeld**  
**BC-19-203**  
7 cm / 2 3/4"



1/2

**Mellinger-Axenfeld**  
**BC-19-204**  
7 cm / 2 3/4"



**Mellinger beard**  
**BC-19-205** **BC-19-206**  
5 cm / 2"    7 cm / 2¾"  
Children    adult



**Sauer**  
**BC-19-207**  
3 cm / 1¼"



**Castroviejo**  
**BC-19-208**  
8 cm / 3¼"



**Stevenson**  
**BC-19-209**  
7 cm / 2¾"



**Mueller**  
**BC-19-210**  
7 cm / 2¾"



**Agricola**  
**BC-19-211**  
4 cm / 1½"

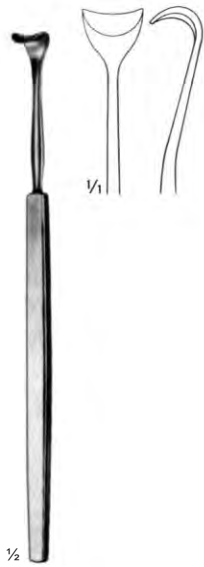

**Conway**  
**BC-19-212**  
 13 cm / 5"



**Desmarres**  
**BC-19-213**  
 13 cm / 5"



**Desmarres**  
 13 cm / 5"



**BC-19-214**



**BC-19-215**



**BC-19-216**



**BC-19-217**



1/2



**BC-19-218**



**BC-19-219**



**BC-19-220**

**Graefe**  
 13 cm / 5"



**Becker**  
**BC-19-221**  
 13 cm / 5"



**Deutschmann**  
**BC-19-222**  
13 cm / 5"



**Wheeler**  
**BC-19-223**  
12 cm / 4 1/2"



**Castroviejo**  
**BC-19-224**  
9 cm / 3 1/2"



**Castroviejo**  
**BC-19-225**  
9 cm / 3 1/2"



**Castroviejo**  
**BC-19-226**  
9 cm / 3 1/2"



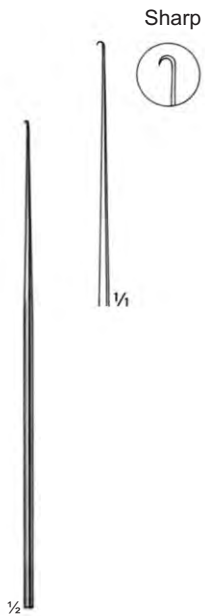

**Mod. Tübingen**  
**BC-19-227**  
 14 cm / 5<sup>2</sup>/<sub>8</sub>"



**Mod. Bonn**  
**BC-19-228**  
 14 cm / 5<sup>2</sup>/<sub>8</sub>"



**Hirschmann**  
**BC-19-229**  
 10 cm / 4"

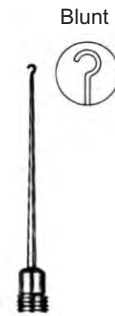

**Knolle**  
**BC-19-230**  
 13 cm / 5"



**Jeffe-knolle**  
**BC-19-231**  
 13 cm / 5"



**Graefe**  
**BC-19-232**  
 12 cm / 4<sup>3</sup>/<sub>4</sub>"



**Graefe**  
**BC-19-233**  
 12 cm / 4<sup>3</sup>/<sub>4</sub>"



**Meyer-Schwickerath**  
**BC-19-234**  
 13 cm / 5"



**O'Conner**  
**BC-19-235**  
 12 cm / 4<sup>3</sup>/<sub>4</sub>"



**Wiener**  
**BC-19-236**  
 13 cm / 5"



**Wiener**  
**BC-19-237**  
 13 cm / 5"

Various Hooks



Iris Hook

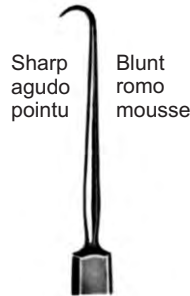

**Wiener**  
BC-19-238 13 cm / 5"    BC-19-239 13 cm / 5"

Iris Retractor

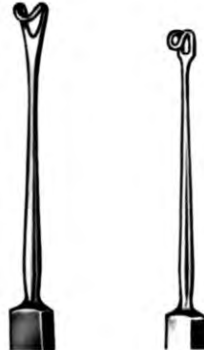

**Graefe** BC-19-240 13 cm / 5"    **McGannan** BC-19-241 13 cm / 5"

Sclera Hook



**Berens** BC-19-242 12 cm / 4¾"

Extraction Hook

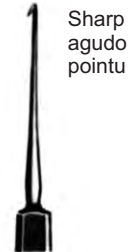

**Stevens** BC-19-243 12 cm / 4¾"

Cyclodialysis Spatulas

Cyclodialysis Spatulas and Spoon, graduated

Iris spatula

Double spatula



**Castroviejo**  
14 cm / 5½"

Width of spatula  
mm  
BC-19-244 0.50  
BC-19-245 0.75  
BC-19-246 1.00



**Castroviejo**  
BC-19-247 12 cm / 4¾"



**Wheeler**  
BC-19-248 12 cm / 4¾"



**Lindner**  
BC-19-249 13 cm / 5"



**Smith-Fisher**  
BC-19-250 12 cm / 4¾"



**Green**  
BC-19-251 12 cm / 4¾"

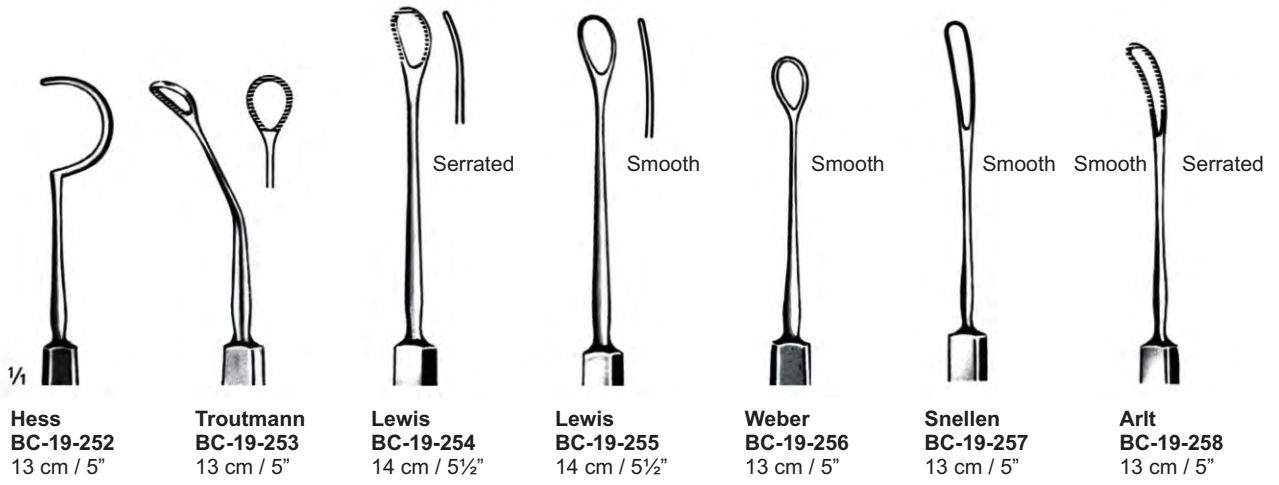

Cataract Spoons



Chalazion Curettes, Lachrymal Sac Dissector

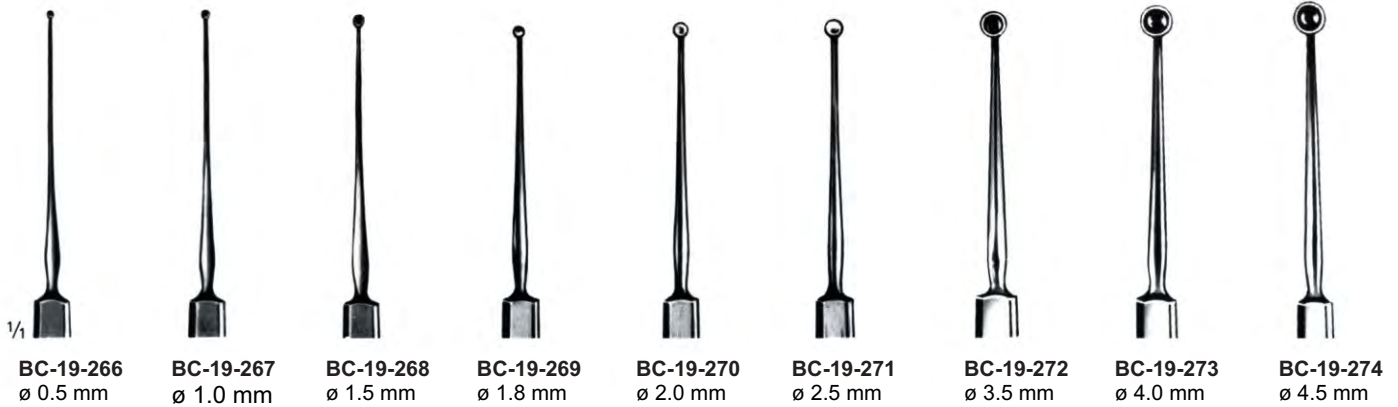

Meyhoefer

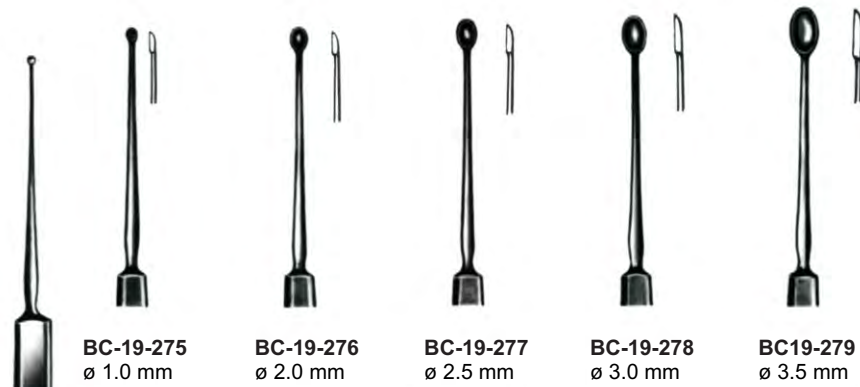

Hebra

Chalazion Curettes, Lachrymal Sac Dissector  
double-ended, sharp



Axenfeld  
BC-19-285  
13 cm / 5"

Lang  
BC-19-286  
13 cm / 5"

Evisceration Spoons



Bunge

Meyhoefer  
Hebra  
Bunge



Needle and spud, in round sliding handle

Needle and Gouge, in round sliding handle

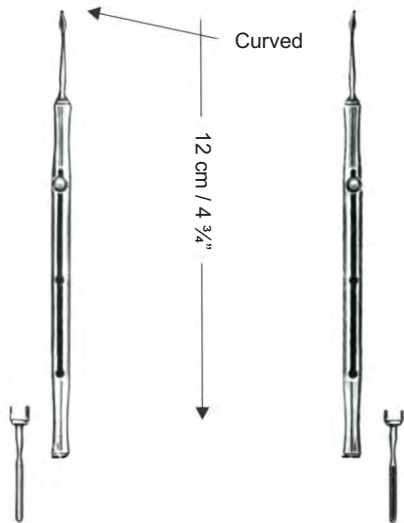

**Dix**  
**BC-19-287**  
 12 cm / 4 3/4"

**Dix**  
**BC-19-288**  
 12 cm / 4 3/4"

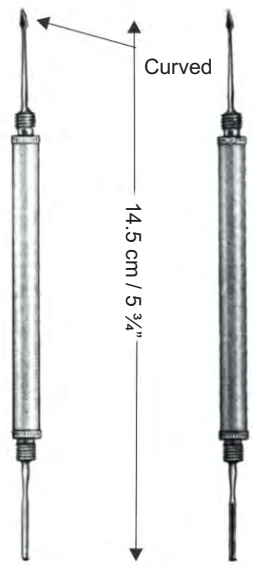

**Dix**  
**BC-19-289**  
 12 cm / 5 3/4"

**Dix**  
**BC-19-290**  
 12 cm / 5 3/4"

Curved



**BC-19-291**  
 Needle only

**BC-19-292**  
 Spud only

**BC-19-293**  
 Gouge only

Needles and Spud, in reversible screw-handle

Foreign Body remover and Magnetic Eye probe in reversible handle



1/2  
**BC-19-294**  
 17 cm / 6 3/4"

**BC-19-295**  
 17 cm / 6 3/4"

With magnifier

Various Spatulas



Iris Spatulas



**Wecker**  
**BC-19-300**  
13 cm / 5"



**Wecker**  
**BC-19-301**  
13 cm / 5"



**Stock**  
**BC-19-302**  
13 cm / 5"



**Culler**  
**BC-19-303**  
13 cm / 5"



**Suker**  
**BC-19-304**  
14 cm / 5½"

Cyclodialysis Spatulas

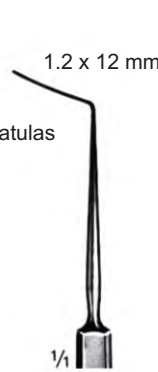

**Elsching**  
**BC-19-305**  
13 cm / 5"



**Castroviejo**  
**BC-19-306**  
13 cm / 5"



**Castroviejo**  
**BC-19-307**  
14 cm / 5½"

Width of spatula

0.5 mm      1.0 mm

**BC-19-308**

**BC-19-314**

8 mm

**BC-19-309**

**BC-19-315**

10 mm

**BC-19-310**

**BC-19-316**

12 mm

**BC-19-311**

**BC-19-317**

14 mm

**BC-19-312**

**BC-19-318**

16 mm

**BC-19-313**

**BC-19-319**

18 mm



**Castroviejo-Barraquer**  
Cyclodialysis Spatula



**Castroviejo-Barraquer**  
Cyclodialysis Spatula



**Hirschmann**  
**BC-19-320**  
 13 cm / 5¼"



**Graefe**  
**BC-19-321**  
 13 cm / 5¼"



**McGannan**  
**BC-19-322**  
 13 cm / 5¼"



**Guthrie**  
**BC-19-323**  
 12 cm / 4¾"



**Guthrie**  
**BC-19-324**  
 13 cm / 5¼"



**Knapp**  
**BC-19-325**  
 13 cm / 5¼"



**Rollet**  
**BC-19-326**  
 13 cm / 5¼"



**Fink**  
**BC-19-327**  
 13 cm / 5¼"

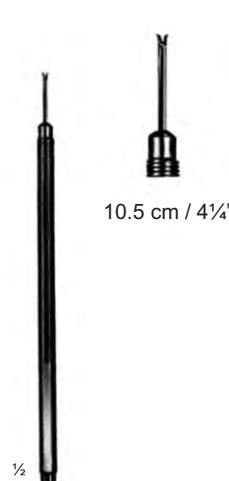

10.5 cm / 4¼"

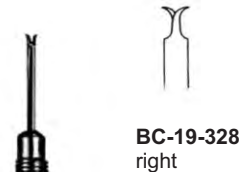

**BC-19-328**  
 right



**BC-19-328A**  
 left



**BC-19-329**



**BC-19-330**



**BC-19-331**

**Knapp-Rollet**  
Flexible, sharp



**BC-19-332**  
Sharp



**BC-19-333**  
blunt



**BC-19-334**  
Sharp



**BC-19-335**  
blunt

**Axenfeld**





Protector insulated



**Arruga**  
 BC-19-336



**Arruga**  
 BC-19-337



**Stevens**  
 BC-19-338



**Stevens**  
 BC-19-339



**Jameson**  
 BC-19-340



**Green**  
 BC-19-341



1/2



**Graefe**  
 BC-19-342



**Graefe**  
 BC-19-343



**Graefe**  
 BC-19-344



**Jaeger**  
 BC-19-345



**Jaeger**  
 BC-19-346



**Arruga**  
 BC-19-347  
 left



**Arruga**  
 BC-19-348  
 right



1/2



**Sautter**  
**BC-19-349**  
14.5 cm / 5 3/4"



**Sautter**  
**BC-19-350**  
14.5 cm / 5 3/4"



**Sautter**  
**BC-19-351**  
14.5 cm / 5 3/4"

Measuring Range: 15 mm



**Castroviejo**  
**BC-19-352**

Measuring Range: 20 mm



**Castroviejo**  
**BC-19-353**

Measuring Range: 20 mm



**Castroviejo-Schachar**  
**BC-19-354**



1/2

**Connin-Amsler**  
**BC-19-355**



1/2



**Wecker**  
 BC-19-356



**Wecker**  
 BC-19-357



**Stock**  
 BC-19-358



1/2



**Culler**  
 BC-19-359



1/2

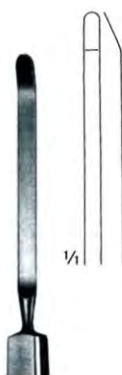

**Culler**  
 BC-19-360

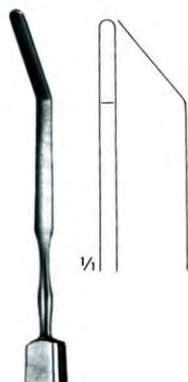

**Suker**  
 BC-19-361



**Bangerter**

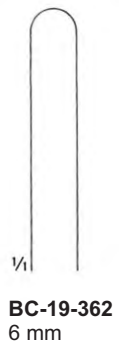

**BC-19-362**  
 6 mm

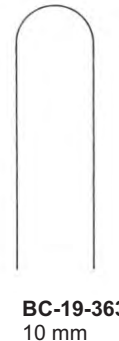

**BC-19-363**  
 10 mm

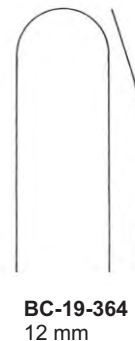

**BC-19-364**  
 12 mm

1.2 x 12 mm  





**Elschnig**  
BC-19-365

0.25 x 12 mm  





**Barraquer-Fino**  
BC-19-366

1.2 x 10 mm  





**Castroviejo**  
BC-19-367

1.5 x 15 mm  



**Castroviejo**  
BC-19-368



0.8 x 15 mm  



**Castroviejo**  
BC-19-369  
9 cm / 3 1/2"



**Castroviejo**  
BC-19-370  
9.5 cm / 3 3/4"

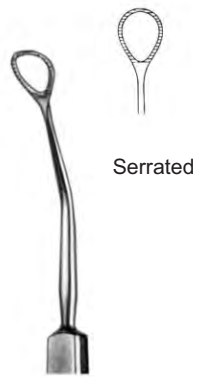

**Troutman**  
**BC-19-371**  
13 cm / 5¼"

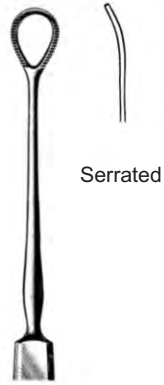

**Lewis**  
**BC-19-372**

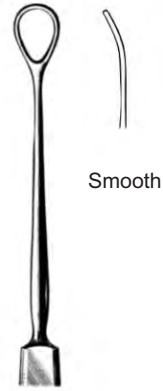

**Lewis**  
**BC-19-373**



**Weber**  
**BC-19-374**



½



**Weber**  
**BC-19-375**



**Snellen**  
**BC-19-376**



**Art**



**BC-19-377**  
Smooth

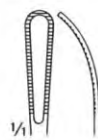

**BC-19-378**  
Serrated



**Sinskey**  
BC-19-379  
13 cm / 5"



**Sinskey-Cornic**  
BC-19-380  
13 cm / 5"



**Sinskey**  
BC-19-381  
13 cm / 5"



**Jaffe-Berchert**  
BC-19-382  
11 cm / 4½"



Hess  
BC-19-383



Graefe  
BC-19-384



Graefe  
BC-19-385



Daviel  
BC-19-386



Daviel  
BC-19-387



$\frac{1}{2}$   
13 cm / 5"



Knapp  
BC-19-388



Wells  
BC-19-389  
small



Wells  
BC-19-390  
large



**BC-19-391**  
0.5 mm ø



**BC-19-392**  
1.0 mm ø



**BC-19-393**  
1.5 mm ø



**BC-19-394**  
1.8 mm ø



**BC-19-395**  
2.0 mm ø



**BC-19-396**  
2.5 mm ø



**BC-19-397**  
3.5 mm ø



**BC-19-398**  
4.0 mm ø



**BC-19-399**  
4.5 mm ø

Meyhoefer



**BC-19-400**  
1.0 mm ø



**BC-19-401**  
2.0 mm ø



**BC-19-402**  
2.5 mm ø



**BC-19-403**  
3.0 mm ø



**BC-19-404**  
3.5 mm ø

Hebra



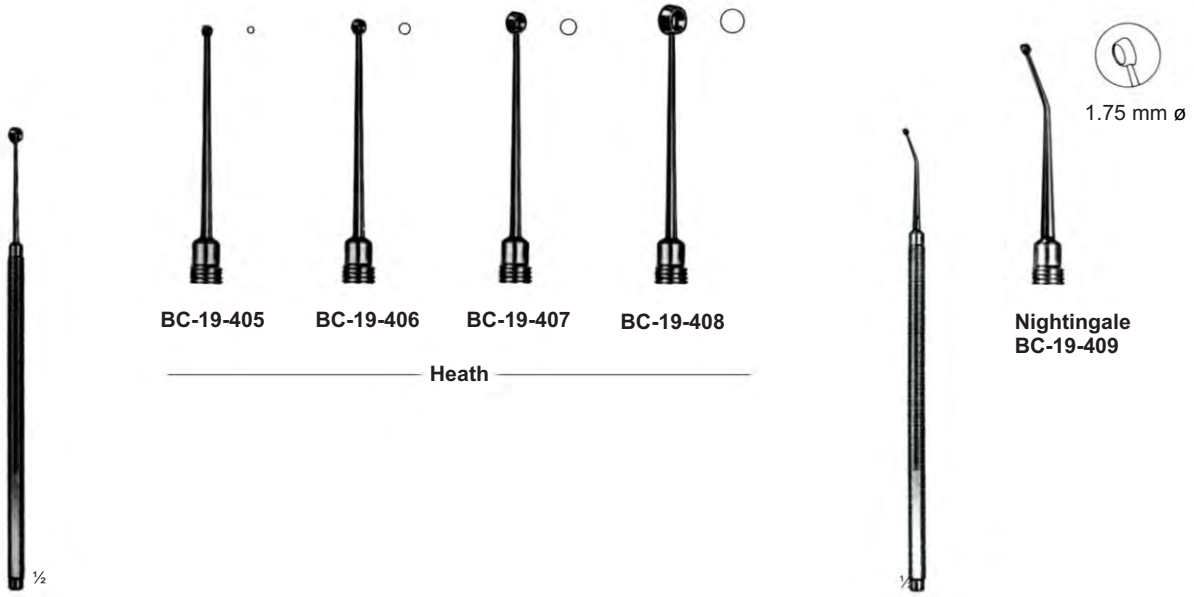

BC-19-405

BC-19-406

BC-19-407

BC-19-408

Nightingale  
BC-19-409

Heath



Axenfeld  
BC-19-410



Lang  
BC-19-411



**Kirby**  
**BC-19-415**  
10 cm / 4"



**Kirby**  
**BC-19-416**  
10 cm / 4"



**Kirby**  
**BC-19-417**  
10 cm / 4"

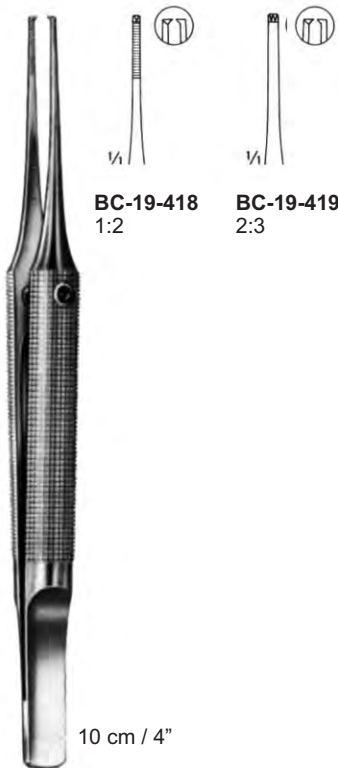

**BC-19-418**  
1:2

**BC-19-419**  
2:3

10 cm / 4"



**BC-19-420**  
10 cm / 4"



**BC-19-421**  
10 cm / 4"



**BC-19-422**  
10 cm / 4"



**Castroviejo**  
 Width os spatula

- BC-19-423 0.50 mm
- BC-19-424 0.75 mm
- BC-19-425 1.00 mm

**Castroviejo**

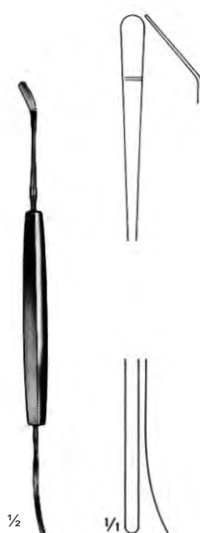

**Castroviejo**  
 BC-19-426



**Wheeler**  
 BC-19-427



**Lindner**  
 BC-19-428



**Smith-Fisher**  
 BC-19-429



**Green**  
 BC-19-430

Without teeth



**Foerster**  
**BC-19-431**  
8.5 cm / 3 1/2"

With 1:2 teeth



**Foerster**  
**BC-19-432**  
8.5 cm / 3 1/2"



**Foerster**  
**BC-19-433**  
8.5 cm / 3 1/2"



**Foerster**  
**BC-19-434**  
8.5 cm / 3 1/2"



**Graefe**  
**BC-19-435** 0.5 mm  
**BC-19-436** 0.7 mm  
**BC-19-437** 1.0 mm  
7 cm / 2 3/4"



**Graefe**  
**BC-19-438** 0.5 mm  
**BC-19-439** 0.7 mm  
**BC-19-440** 1.0 mm  
7 cm / 2 3/4"



**Graefe**  
**BC-19-441** 0.5 mm  
**BC-19-442** 0.7 mm  
**BC-19-443** 1.0 mm  
7 cm / 2 3/4"



**Graefe**  
**BC-19-444** 0.5 mm  
**BC-19-445** 0.7 mm  
**BC-19-446** 1.0 mm  
7 cm / 2 3/4"



**Graefe**  
**BC-19-447**  
 10 cm / 4"



**Graefe**  
**BC-19-448**  
 10 cm / 4"



**Graefe**  
**BC-19-449**  
 10 cm / 4"



**Graefe**  
**BC-19-450**  
 10 cm / 4"



**Graefe**  
**BC-19-451**  
 10 cm / 4"



**Graefe**  
**BC-19-452**  
 10 cm / 4"



**Stevens**  
**BC-19-453**  
 10.5 cm / 4½"



**Stevens**  
**BC-19-454**  
 10.5 cm / 4½"



**Stevens**  
**BC-19-455**  
 10.5 cm / 4½"



**Stevens**  
**BC-19-456**  
 10.5 cm / 4½"



**Stevens**  
**BC-19-457**  
 10.5 cm / 4½"



**Stevens**  
**BC-19-458**  
 10.5 cm / 4½"



**Elliot**  
**BC-19-459**  
10 cm / 4"

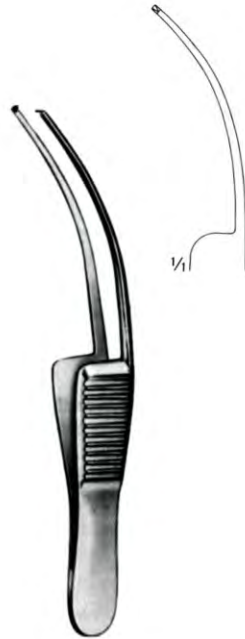

**Fischer**  
**BC-19-460**  
7 cm / 2 3/4"

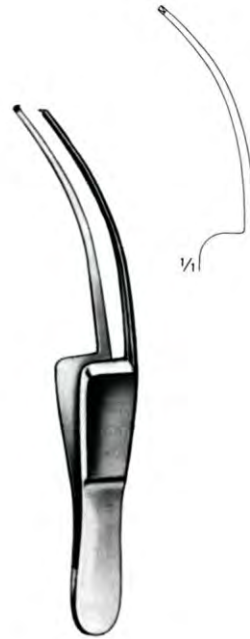

**Fischer-Arnt**  
**BC-19-461**  
7 cm / 2 3/4"



**Hess**  
**BC-19-462**  
7 cm / 2 3/4"



**Hess**  
**BC-19-463**  
7 cm / 2 3/4"

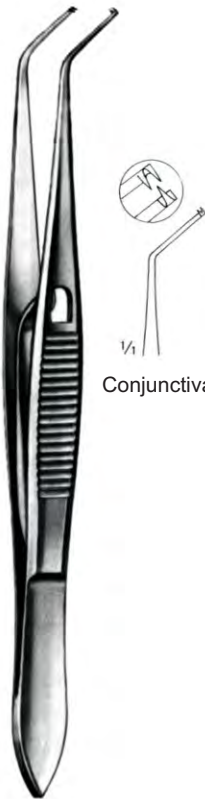

**O'Connor**  
**BC-19-464**  
10 cm / 4"

Conjunctival Forceps

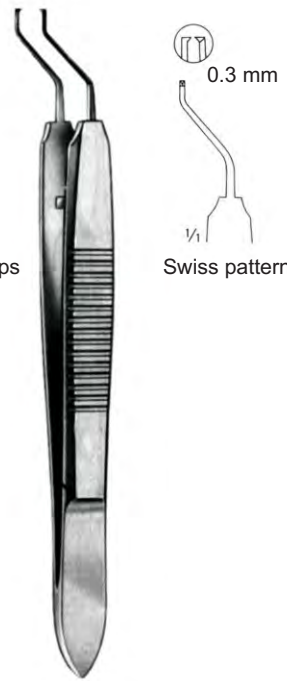

**Hess**  
**BC-19-465**  
9 cm / 3 1/2"

Swiss pattern

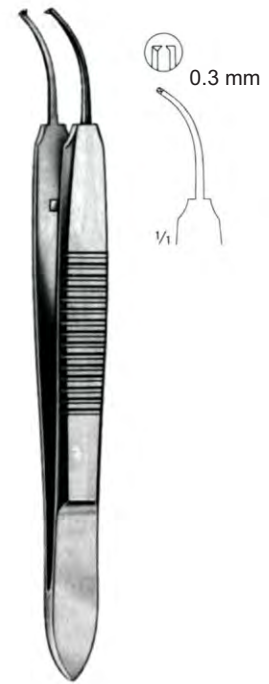

**Hess**  
**BC-19-466**  
9 cm / 3 1/2"



**Mod.Bonn**  
**BC-19-467**  
 7 cm / 2¾"



**Mod.Bonn**  
**BC-19-468**  
 7 cm / 2¾"

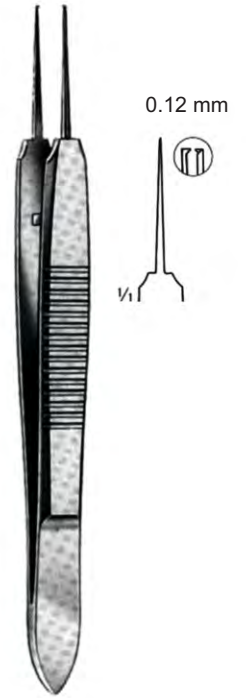

**Mod.Bonn**  
**BC-19-469**  
 10 cm / 4"



**Mod.Bonn**  
**BC-19-470**  
 7 cm / 2¾"



**Bishop-Harman**  
**BC-19-471**  
 8.5 cm / 3½"

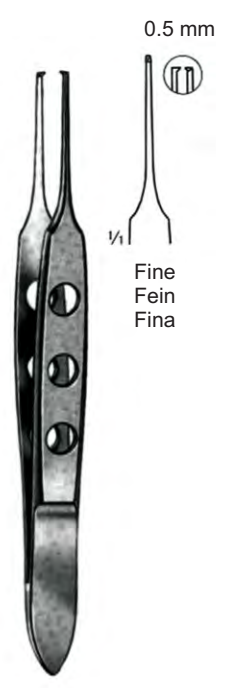

**Bishop-Harman**  
**BC-19-472**  
 8.5 cm / 3½"



**Bishop-Harman**  
**BC-19-473**  
 8.5 cm / 3½"



**Bishop-Harman**  
**BC-19-474**  
 8.5 cm / 3½"



**Tübingen**  
**BC-19-475**  
10 cm / 4"



**Bonn**  
**BC-19-476**  
10 cm / 4"



**Tubingen**  
**BC-19-477**  
10 cm / 4"





**Chandler**  
**BC-19-478**  
 7 cm / 2¾"



**Chandler**  
**BC-19-479**  
 7 cm / 2¾"



**Fuche**  
**BC-19-480**  
 7 cm / 2¾"



**Gill**  
**BC-19-481**  
 7.5 cm / 3"

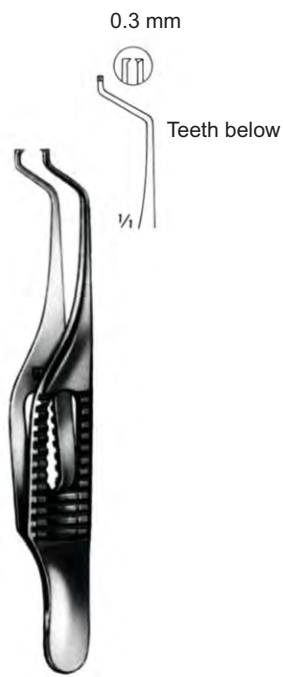

**Gill-Hess**  
**BC-19-482**  
 7.5 cm / 3"

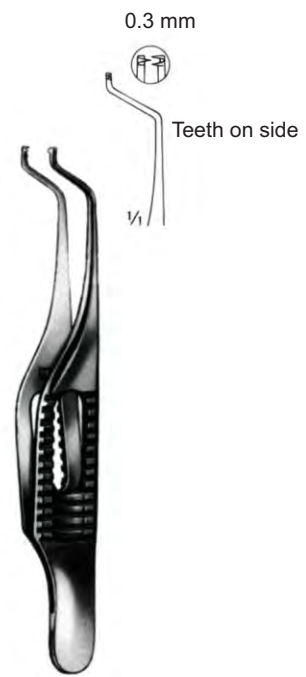

**Gill-Hess**  
**BC-19-483**  
 7.5 cm / 3"



**Barraquer-Katzin**  
BC-19-484  
7 cm / 2 3/4"

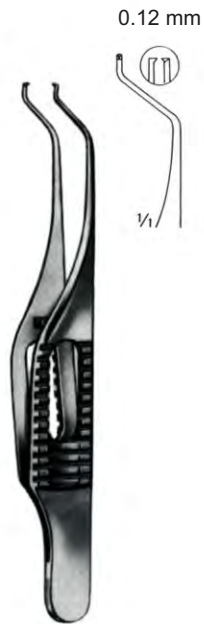

**Troutman (Colibri)**  
BC-19-485  
7.5 cm / 3"

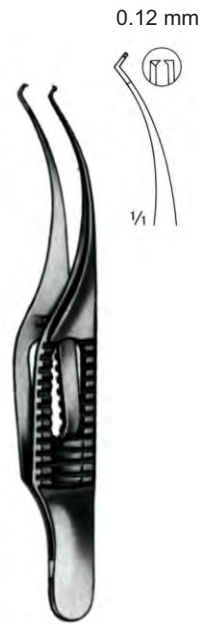

**Barraquer (Colibri)**  
BC-19-486  
7 cm / 2 3/4"

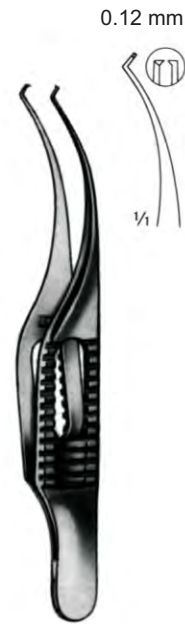

**Barraquer-Katzin (Colibri)**  
BC-19-487  
7 cm / 2 3/4"



**Barraquer (Colibri)**  
BC-19-488  
7 cm / 2 3/4"



**Kirby-Artur**  
BC-19-489  
9 cm / 3 1/2"



**Kirby-Artur**  
BC-19-490  
9 cm / 3 1/2"



**Castroviejo-Colibri**  
BC-19-491  
10 cm / 4"



**Mauensee-Colibri**  
BC-19-492  
10 cm / 4"



**Willard-Colibri**  
BC-19-493  
13 cm / 5 1/4"



**Gill-Arruga**  
**BC-19-494**  
7.5 cm / 3"

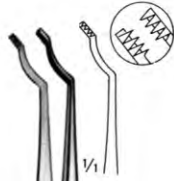

**Terson**  
**BC-19-495**  
9 cm / 3½"

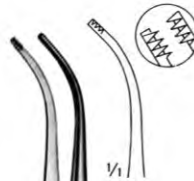

**Schweigger**  
**BC-19-496**  
10 cm / 4"



**Schweigger**  
**BC-19-497**  
10 cm / 4"



**Stock**  
**BC-19-498**  
9.5 cm / 3¾"

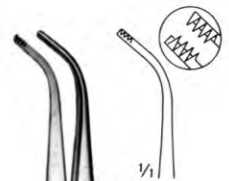

**Elschnig**  
**BC-19-499**  
10 cm / 4"



**Hess**  
**BC-19-500**  
6 cm / 2½"



**Hess**  
**BC-19-501**  
6.5 cm / 2½"



**Fuchs**  
**BC-19-502**  
7 cm / 2¾"

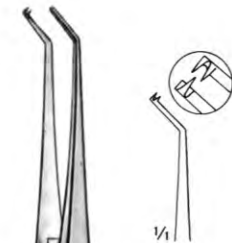

**Terson**  
**BC-19-503**  
9.5 cm / 3¾"



**Arruga**  
**BC-19-504**  
 10 cm / 4"



Calibrated

**Arruga**  
**BC-19-505**  
 10 cm / 4"



**Arruga**  
**BC-19-506**  
 10 cm / 4"



Calibrated

**Arruga-Elschnig**  
**BC-19-507**  
 10 cm / 4"



**Binkhorst**  
**BC-19-508**  
 7 cm / 2¾"



**Clayman**  
**BC-19-509**  
 with irrigator

**BC-19-510**  
 Without irrigator



**Shepard**  
**BC-19-511**  
 with irrigator

**BC-19-512**  
 Without irrigator



**Shepard II**  
**BC-19-513**  
 with irrigator

**BC-19-514**  
 Without irrigator



**Kalt**  
**BC-19-515**  
10 cm / 4"



**Kalt**  
**BC-19-516**  
10 cm / 4"



**Castroviejo**  
**BC-19-517**  
10 cm / 4"



**Castroviejo**  
**BC-19-518**  
10 cm / 4"



**Elschnig**  
**BC-19-519**  
10 cm / 4"



**Swiss pattern**  
**BC-19-520**  
9 cm / 3 1/2"



**Graefe**  
 11 cm / 4½"



0.3 mm



**Sauer  
 Mod. Martin  
 BC-19-523**  
 7.5 cm / 3"

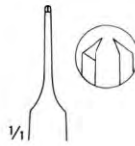

0.3 mm



**Sauer  
 Mod. Martin  
 BC-19-524**  
 7.5 cm / 3"

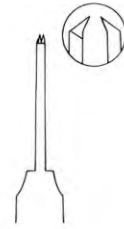
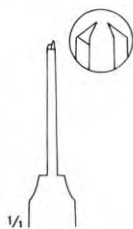



**Barraquer**  
**BC-19-529**  
10 cm / 4"



**Green**  
10 cm / 4"

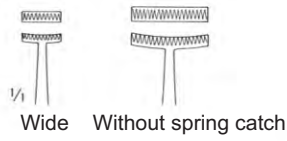

Wide Without spring catch

**BC-19-530** 5 mm  
**BC-19-531** 10 mm

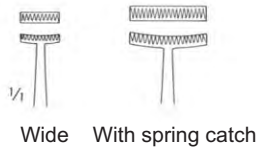

Wide With spring catch

**BC-19-532** 5 mm  
**BC-19-533** 10 mm



**Flieringa Ring Forceps**

**Barraquer-Llovera**  
**BC-19-534**  
9 cm / 3½"



**Elschnig**  
**BC-19-535**  
11 cm / 4½"



**Elschnig**  
**BC-19-536**  
11 cm / 4½"



**BC-19-537**  
11 cm / 4½"  
2:3

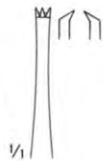

**BC-19-538**  
11 cm / 4½"  
3:4

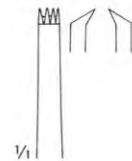

**Lester**  
9 cm / 3½"



**BC-19-539**



**BC-19-540**





**Moorfield**  
**BC-19-541**  
 10 cm / 4"

Straight

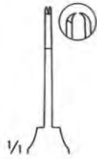

**Castroviejo**  
 10 cm / 4"

Curved



**Castroviejo**  
 10 cm / 4"



**St. Martin**  
**BC-19-550**  
 7 cm / 2 3/4"

Width of teeth

- BC-19-542** 0.12 mm
- BC-19-543** 0.3 mm
- BC-19-544** 0.5 mm
- BC-19-545** 1.5 mm
- BC-19-546** 1.0 mm

Width of teeth

- BC-19-547** 0.5 mm
- BC-19-548** 1.5 mm
- BC-19-549** 1.0 mm

0.8 mm

Muscular Forceps

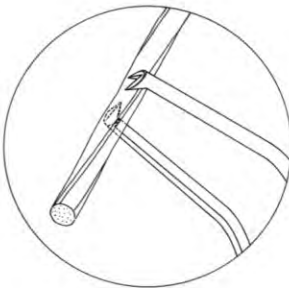

**Troutman Rectus**  
**BC-19-551**  
 8.5 cm / 3 1/2"

Anterior Chamber Forceps



**Barraquer**  
**BC-19-552**  
 5.5 cm / 2 1/4"



**Barraquer**  
**BC-19-553**  
 5.5 cm / 2 1/4"



**Barraquer**  
**BC-19-554**  
 5.5 cm / 2 1/4"



**Bonaccolto**  
**BC-19-555**  
10 cm / 4"



**Bonaccolto**  
**BC-19-556**  
10 cm / 4"



**Nugent**  
10 cm / 4"

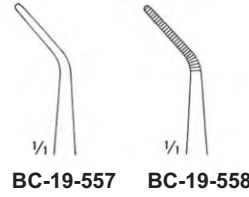

**BC-19-557**   **BC-19-558**



**Bonaccolto**  
**BC-19-559**  
11 cm / 4½"



**Dastoor**  
**BC-19-560**  
10 cm / 4"



**Dastoor**  
**BC-19-561**  
11 cm / 4½"



**Dastoor**  
**BC-19-562**  
11 cm / 4½"



**Dastoor**  
**BC-19-563**  
11 cm / 4½"



**McCullough**  
**BC-19-564**  
 9.5 cm / 3 3/4"



**McCullough**  
**BC-19-565**  
 9.5 cm / 3 3/4"



**Jameson**  
**BC-19-566**  
 10 cm / 4"

**Jameson**  
**BC-19-567**  
 10 cm / 4"



**Prince**  
**BC-19-568**  
 10 cm / 4"

**Prince**  
**BC-19-569**  
 10 cm / 4"



**Sattler**  
**BC-19-570**  
 10 cm / 4"

**Sattler**  
**BC-19-571**  
 10 cm / 4"

Muscular Forceps

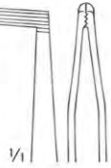

BC-19-572

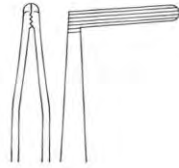

BC-19-573

1/2

**Blascovics**  
9 cm / 3 1/2"



1/2

**Blascovics**  
9 cm / 3 1/2"



1/2

**Berke**  
10 cm / 4"



BC-19-575

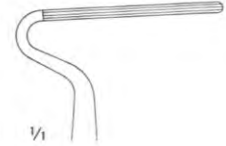

BC-19-576



1/2

**Fink-Jameson**  
BC-19-577  
10 cm / 4"

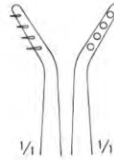

1/2

**Berens**  
BC-19-578  
10 cm / 4"



1/2

**Bangerter**  
BC-19-579  
10 cm / 4"

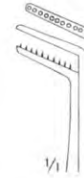



**Lordan**  
**BC-19-580**  
 9 cm / 3½"



**Cauer**  
**BC-19-581**  
 10 cm / 4"

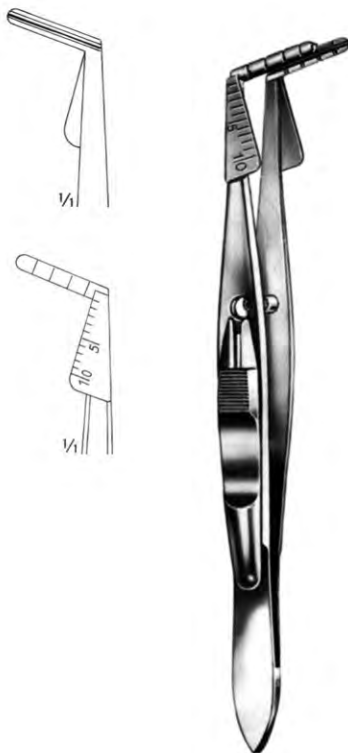

**Berens**  
**BC-19-582**  
 10 cm / 4"



**Snellen**  
**BC-19-583**  
 10 cm / 4"

**Snellen**  
**BC-19-584**  
 10 cm / 4"



**Mod. Tübingen**  
**BC-19-585**  
10 cm / 4"



**Paufique**  
**BC-19-586**  
8.5 cm / 3 1/2"



**Paufique**  
**BC-19-587**  
8.5 cm / 3 1/2"



**Barraquer mod.**  
**BC-19-588**  
10.5 cm / 4"



**McPherson**  
**BC-19-589**  
10 cm / 4"



**McPherson**  
**BC-19-590**  
10 cm / 4"



0.2 mm



**Dermot Pierse**  
**BC-19-591**  
 8 cm / 3 1/4"

0.2 mm



**Dermot Pierse**  
**BC-19-592**  
 8 cm / 3 1/4"

0.2 mm



**Dermot Pierse**  
**BC-19-593**  
 8 cm / 3 1/4"

0.3 mm



**Dermot Pierse**  
**BC-19-594**  
 8 cm / 3 1/4"

0.4 mm



**Dermot Pierse**  
**BC-19-595**  
 8 cm / 3 1/4"

0.2 mm



**Dermot Pierse (Colibri)**  
**BC-19-596**  
 8 cm / 3 1/4"

0.3 mm



**Dermot Pierse (Colibri)**  
**BC-19-597**  
 8 cm / 3 1/4"

0.4 mm



**Dermot Pierse (Colibri)**  
**BC-19-598**  
 8 cm / 3 1/4"



**Kelman-McPherson**  
**BC-19-599**  
10 cm / 4"



**Barraquer**  
**BC-19-600**  
7 cm / 2  $\frac{3}{4}$ "  
Suture Removal Forceps



**Castroviejo**  
**BC-19-601**  
10 cm / 4"  
left

**Castroviejo**  
**BC-19-602**  
10 cm / 4"  
right



**Troutman-Castroviejo**  
**BC-19-603**  
10 cm / 4"  
left

**Troutman-Castroviejo**  
**BC-19-604**  
10 cm / 4"  
right





**Troutman-Castroviejo**  
**BC-19-605**  
10 cm / 4"  
right

**Troutman-Castroviejo**  
**BC-19-606**  
10 cm / 4"  
left



**Troutman**  
**BC-19-607**  
10 cm / 4"  
right



**Troutman**  
**BC-19-608**  
10 cm / 4"  
left



**Troutman-Castroviejo**  
**BC-19-609**  
10 cm / 4"



**Katzin**  
**BC-19-610**  
10 cm / 4"  
left



**Katzin**  
**BC-19-611**  
10 cm / 4"  
right



**Katzin**  
**BC-19-612**  
11 cm / 4½"  
left



**Katzin**  
**BC-19-613**  
11 cm / 4½"  
right



**Katzin-Barraquer**  
**BC-19-614**  
10 cm / 4"  
right



**Katzin-Barraquer**  
**BC-19-615**  
10 cm / 4"  
left



**BC-19-616**  
10 cm / 4"



**BC-19-617**  
10 cm / 4"



**Troutman-Castroviejo**  
**BC-19-618**  
10.5 cm / 4"  
right



**Troutman-Castroviejo**  
**BC-19-619**  
10.5 cm / 4"  
left



**Castroviejo**  
**BC-19-620**  
10 cm / 4"



**Castroviejo**  
**BC-19-621**  
10 cm / 4"



**Aebli**  
**BC-19-622**  
10 cm / 4"



**Ong**  
**BC-19-623**  
10 cm / 4"



**BC-19-624**



**BC-19-625**



**BC-19-626**



**Wecker, Mod. Martin**  
**BC-19-627**  
11 cm / 4 1/2"

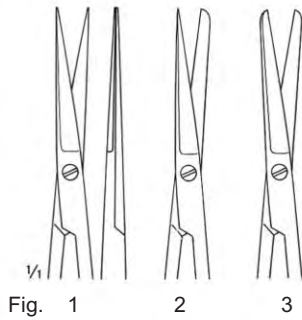

**Noyes**  
**BC-19-628** Fig. 1  
**BC-19-629** Fig. 2  
**BC-19-630** Fig. 3  
12 cm / 4 3/4"

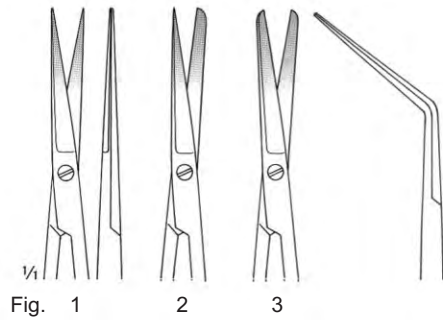

**Noyes**  
**BC-19-631** Fig. 1  
**BC-19-632** Fig. 2  
**BC-19-633** Fig. 3  
12 cm / 4 3/4"



**Gill-Welsch**  
**BC-19-634**  
8 cm / 3/4"



**Gill-Welsch**  
**BC-19-635**  
8 cm / 3/4"



**Gill-Welsch**  
**BC-19-636**  
8.5 cm / 3/2"



**Gill-Welsch**  
**BC-19-637**  
8.5 cm / 3/2"



**Vannas**  
**BC-19-638**  
8 cm / 3/4"



**Vannas**  
**BC-19-639**  
8 cm / 3/4"



**BC-19-640**  
8.5 cm / 3/2"



**Vannas Mod. Tübingen**  
**BC-19-641**  
8.5 cm / 3/2"



**BC-19-642**  
8.5 cm / 3/2"



**Barraquer**  
5.5 cm / 2 1/4"



**BC-19-643**



**BC-19-644**

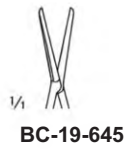

**BC-19-645**



**Castroviejo**  
**BC-19-646**  
10 cm / 4"

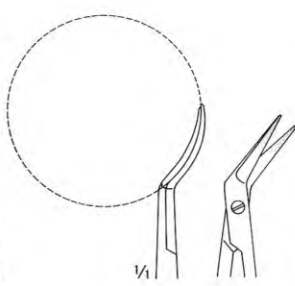

**Castroviejo**  
**BC-19-647**  
10 cm / 4"

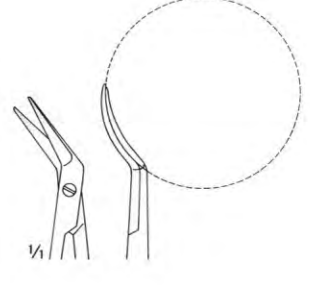

**Castroviejo**  
**BC-19-648**  
11 cm / 4 1/2"



**Castroviejo**  
**BC-19-649**  
11 cm / 4 1/2"



**Castroviejo**  
**BC-19-650**  
11 cm / 4 1/2"

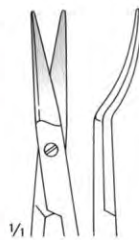

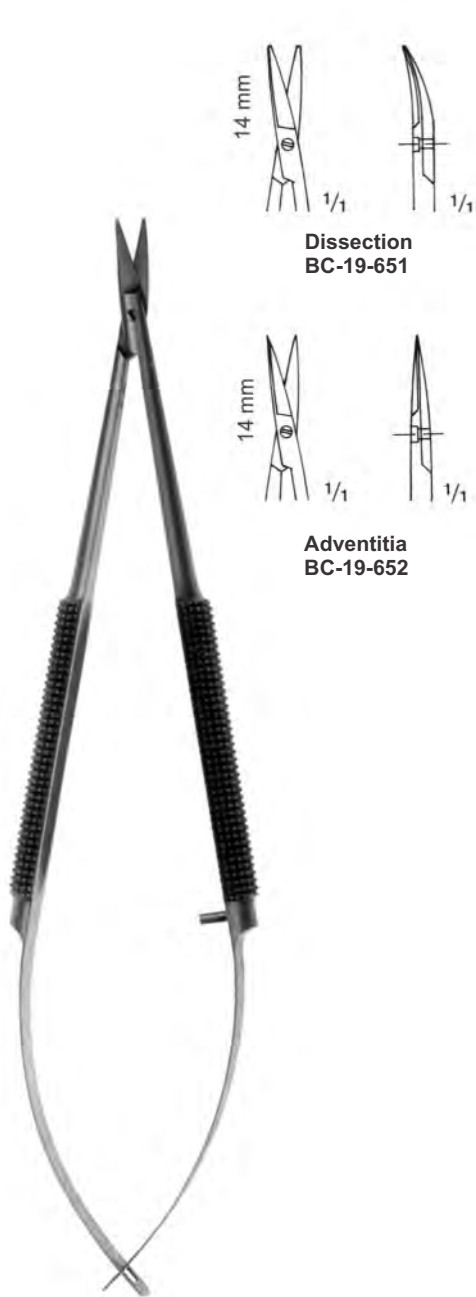

14.5 cm / 5½"

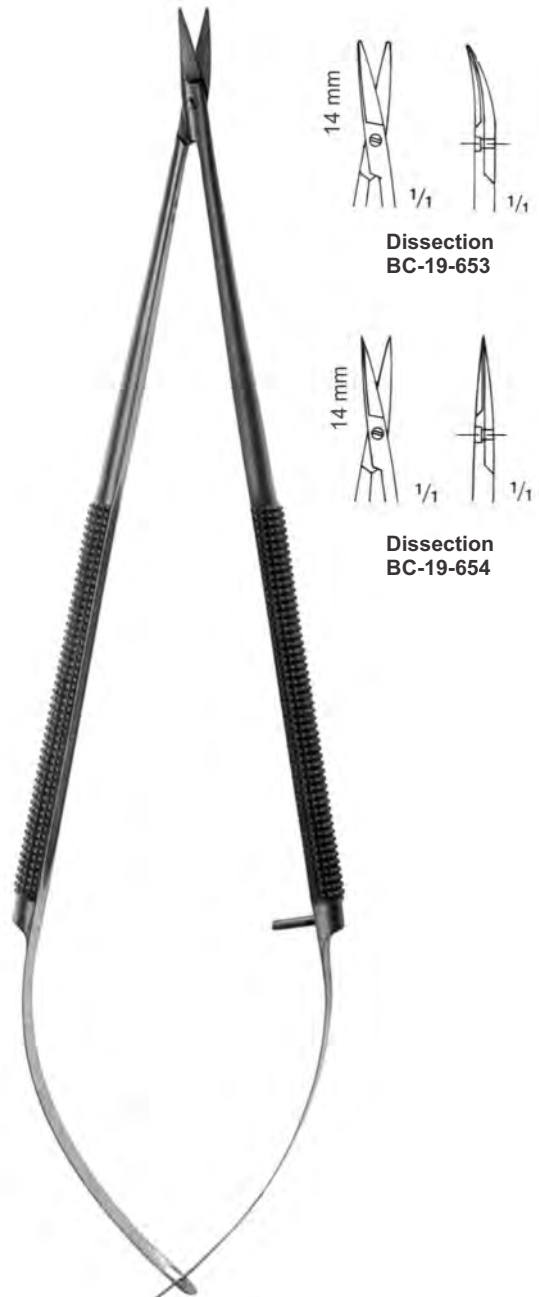

18 cm / 7"



**BC-19-655**  
14.5 cm / 5½"



**BC-19-656**  
18 cm / 7"



**BC-19-657**  
18 cm / 7"



11 cm / 4½"

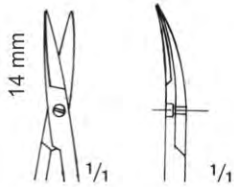

**Dissection**  
**BC-19-658**

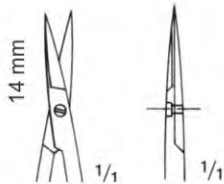

**Adventitia**  
**BC-19-659**



15 cm / 6"

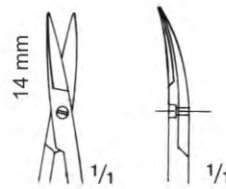

**Dissection**  
**BC-19-660**

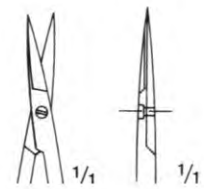

**Adventitia**  
**BC-19-661**

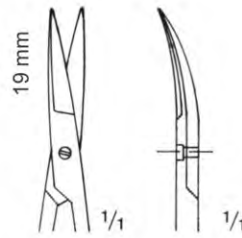

**Dissection**  
**BC-19-662**

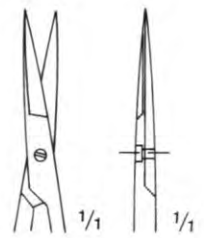

**Adventitia**  
**BC-19-663**

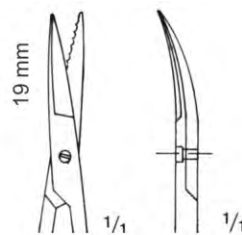

**Dissection**  
**BC-19-664**

Nerve

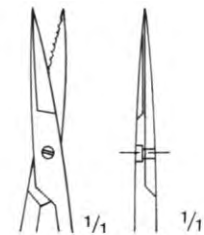

**Adventitia**  
**BC-19-665**





18.5 cm / 7¼"



BC-19-666



BC-19-667



BC-19-668  
 BC-19-669  
 BC-19-670



BC-19-671 16 cm / 6¼"  
 BC-19-672 20 cm / 8"  
 BC-19-673 22.5 cm / 9"



BC-19-674 BC-19-677  
 BC-19-675 BC-19-678  
 BC-19-676 BC-19-679



BC-19-680 BC-19-683 16 cm / 6¼"  
 BC-19-681 BC-19-684 20 cm / 8"  
 BC-19-682 BC-19-685 22.5 cm / 9"



1/2  
18 cm / 7"

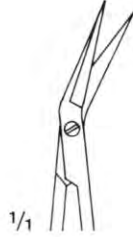

BC-19-686  
25°



BC-19-687  
45°

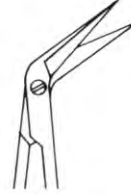

BC-19-688  
60°



BC-19-689  
90°



BC-19-690  
125°



1/2  
18 cm / 7"



BC-19-691  
25°



BC-19-692  
45°



BC-19-693  
60°



BC-19-694  
90°

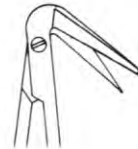

BC-19-695  
125°

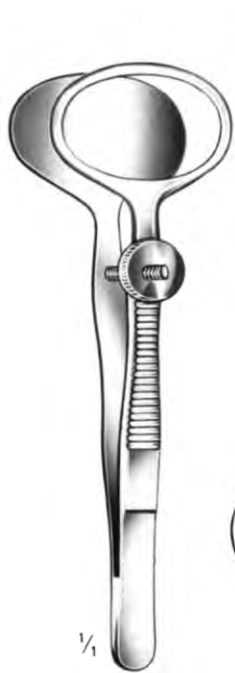

1/4

**Desmarres**  
 9 cm / 3 1/2"



BC-19-696



BC-19-697



BC-19-698

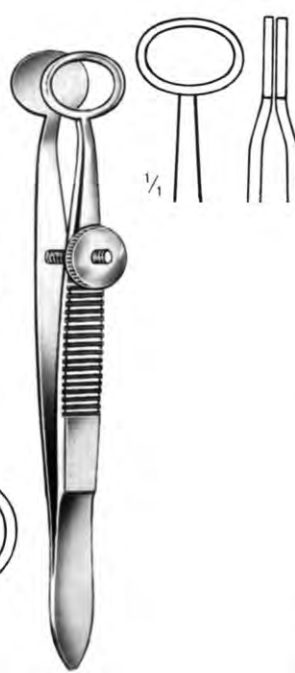

1/4

**Baird**  
 BC-19-699  
 9.5 cm / 3 3/4"



1/4

**Ayer**  
 BC-19-700  
 9 cm / 3 1/2"



**Ayer**  
 BC-19-701  
 9 cm / 3 1/2"

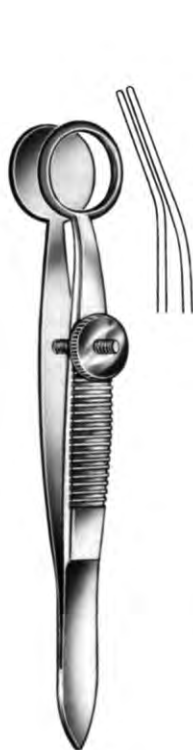

**Hunt**  
 BC-19-702  
 9 cm / 3 1/2"



1/4

**Francis**  
 BC-19-703  
 9 cm / 3 1/2"

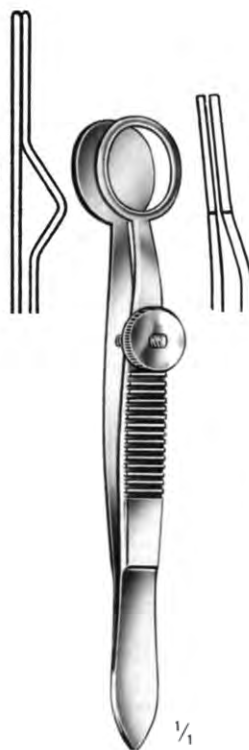

1/4

**Heath**  
 BC-19-704  
 9 cm / 3 1/2"

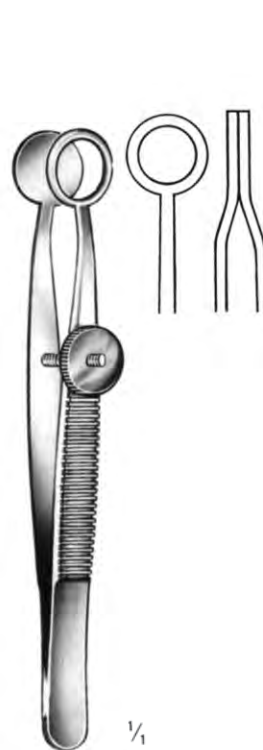

1/4

**Lambert**  
 BC-19-705  
 9 cm / 3 1/2"

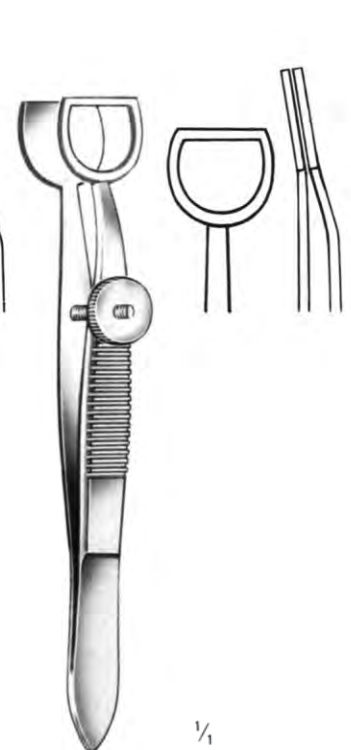

1/4

**Wiess**  
 BC-19-706  
 9.5 cm / 3 3/4"

Fixation and Grasping Forceps



**Castroviejo**  
**BC-19-707**  
9 cm / 3½"



**Castroviejo**  
**BC-19-708**  
9 cm / 3½"



**Castroviejo**  
**BC-19-709**  
9 cm / 3½"



**Castroviejo**  
**BC-19-710**  
9 cm / 3½"



**Eischnig**  
**BC-19-711**  
11 cm / 4½"

Other pattern on request



**Lester**  
**BC-19-712**  
9.5 cm / 3¾"

1 x 2 teeth

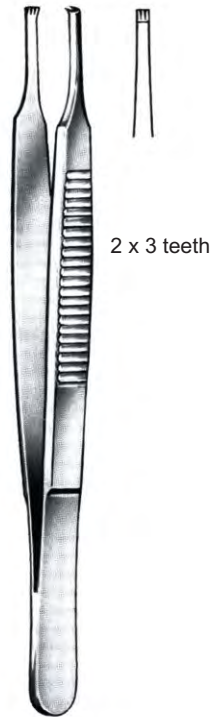

**Lester**  
**BC-19-713**  
9.5 cm / 3¾"

2 x 3 teeth



**Barraquer**  
**BC-19-714**  
10 cm / 4"

Fixation Forceps, without  
spring catch



**Barraquer-Llovera**  
**BC-19-715**  
9 cm / 3½"

Flieringa Ring Forceps



**Woodruff**  
**BC-19-716**  
 13 cm / 5"



**Woodruff**  
**BC-19-717**  
 13 cm / 5"



**De la Roza**  
**BC-19-718**  
 12 cm / 4¾"



**De la Roza**  
**BC-19-719**  
 12 cm / 4¾"



**Jacobi**  
**BC-19-720**  
 14 cm / 5½"

Instruments for Radial Keratotomy



- BC-19-721** 3.0 x 3.5 mm
- BC-19-722** 3.0 x 4.0 mm
- BC-19-723** 3.0 x 4.5 mm
- BC-19-724** 3.5 x 4.0 mm
- BC-19-725** 3.5 x 4.5 mm
- BC-19-726** 3.5 x 5.0 mm

**Bores**

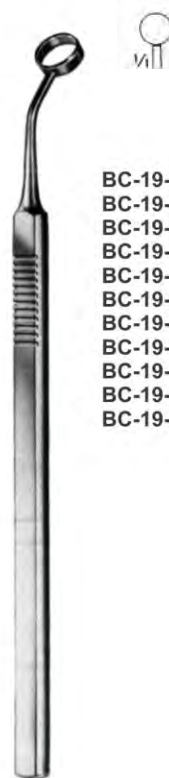

- BC-19-727** 2.75 mm
- BC-19-728** 3.0 mm
- BC-19-729** 3.25 mm
- BC-19-730** 3.75 mm
- BC-19-731** 4.0 mm
- BC-19-732** 4.25 mm
- BC-19-733** 4.5 mm
- BC-19-734** 4.75 mm
- BC-19-735** 5.0 mm
- BC-19-736** 6.0 mm
- BC-19-737** 8.0 mm

**Bores**

Instruments for Radial keratotomy

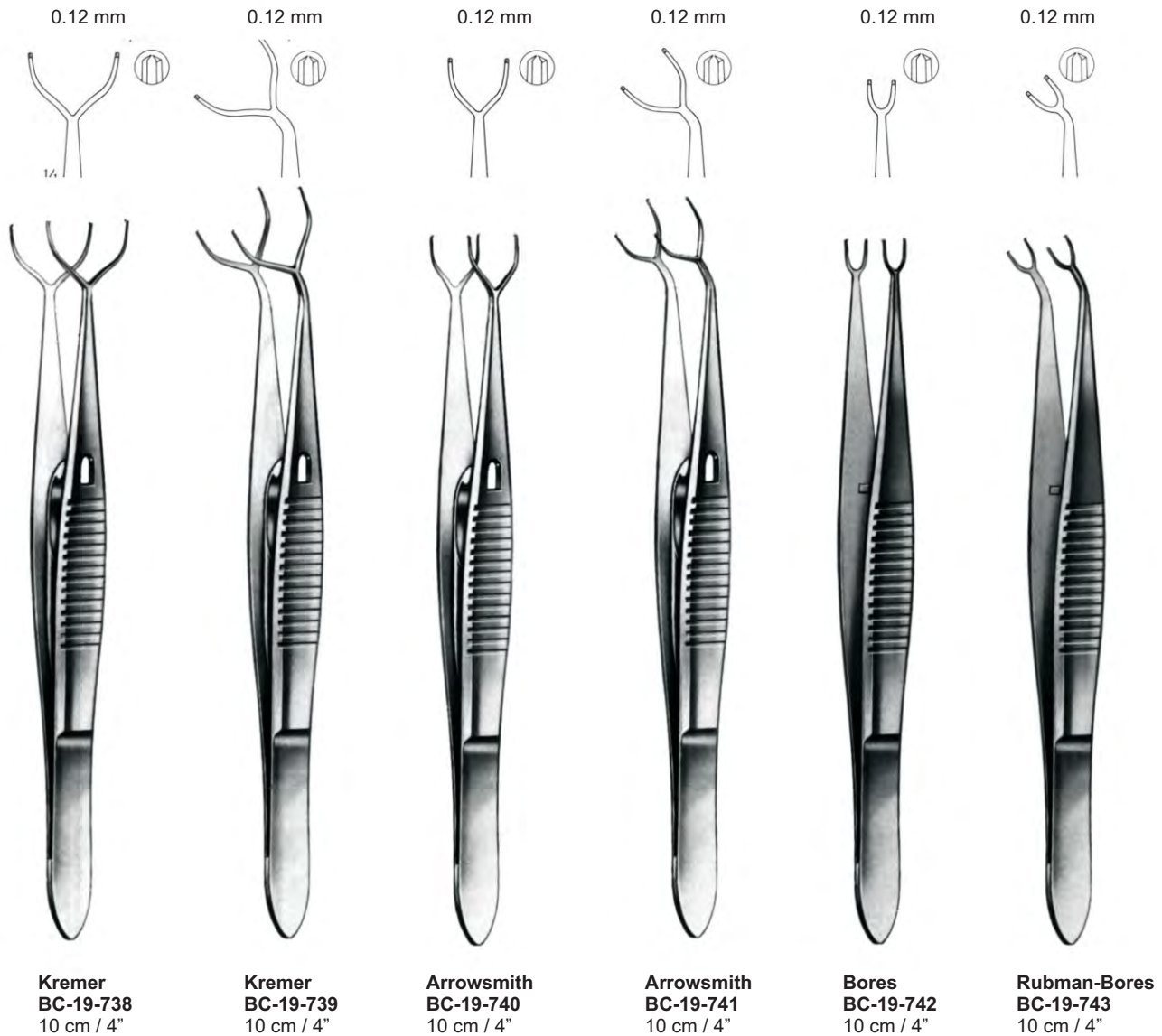

Corneal Fixation Forceps, Straight, 13 mm  
 Corneal Fixation Forceps, Curved, 13 mm  
 Corneal Fixation Forceps, Straight, 8 mm  
 Corneal Fixation Forceps, Curved, 8 mm  
 Corneal Fixation Forceps, Straight, 3 mm  
 Corneal Fixation Forceps, Curved, 3 mm

Instruments for Radial Keratotomy



**Arrowsmith**  
 BC-19-744  
 10 cm / 4"

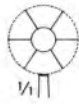

**Bores**  
 BC-19-745  
 10 cm / 4"

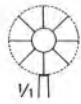

**Bores**  
 BC-19-746  
 10 cm / 4"

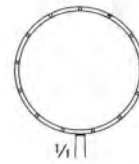

**Bores**  
 BC-19-747  
 10 cm / 4"

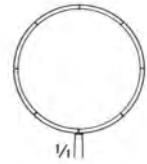

**Thornton**  
 BC-19-748  
 10 cm / 4"

Corneal Marker, 8 blades  
 Corneal Marker, 6 blades  
 Corneal Marker, 8 blades  
 Fixation Ring, 15 mm  
 Fixation Ring, 16 mm

Instruments for Radial Keratotomy



3--5 mm

**BC-19-765**  
3--5--7 mm

**BC-19-766**  
3--6--8 mm



Hoffer

- BC-19-749 3.0 mm
- BC-19-750 3.25 mm
- BC-19-751 3.50 mm
- BC-19-752 3.75 mm
- BC-19-753 4.0 mm
- BC-19-754 4.25 mm
- BC-19-755 4.5 mm
- BC-19-756 4.75 mm
- BC-19-757 5.0 mm
- BC-19-758 5.5 mm
- BC-19-759 6.0 mm
- BC-19-760 7.0 mm
- BC-19-761 8.0 mm
- BC-19-762 9.0 mm
- BC-19-763 11 mm



Hoffer  
BC-19-764



Hoffer

Optical Zone Marker, with cross hairs  
Double Marker with two rings, 3--5 mm  
Triple Marker with three rings, 3--5--7 mm  
Triple Marker with three rings, 3--6--8 mm



Instruments for Radial Keratotomy



**Bores**  
**BC-19-767**  
10 cm / 4"

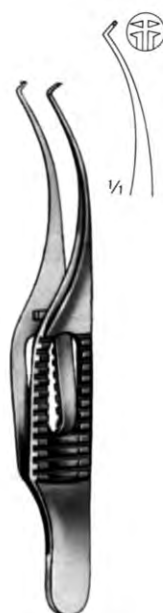

**BC-19-768**



**BC-19-769**  
0.55 mm



**BC-19-770**  
0.6 mm

Incision Spreading Forceps  
Incision Forceps  
Depth Gauge, 0.55 mm  
Depth Gauge, 0.60 mm

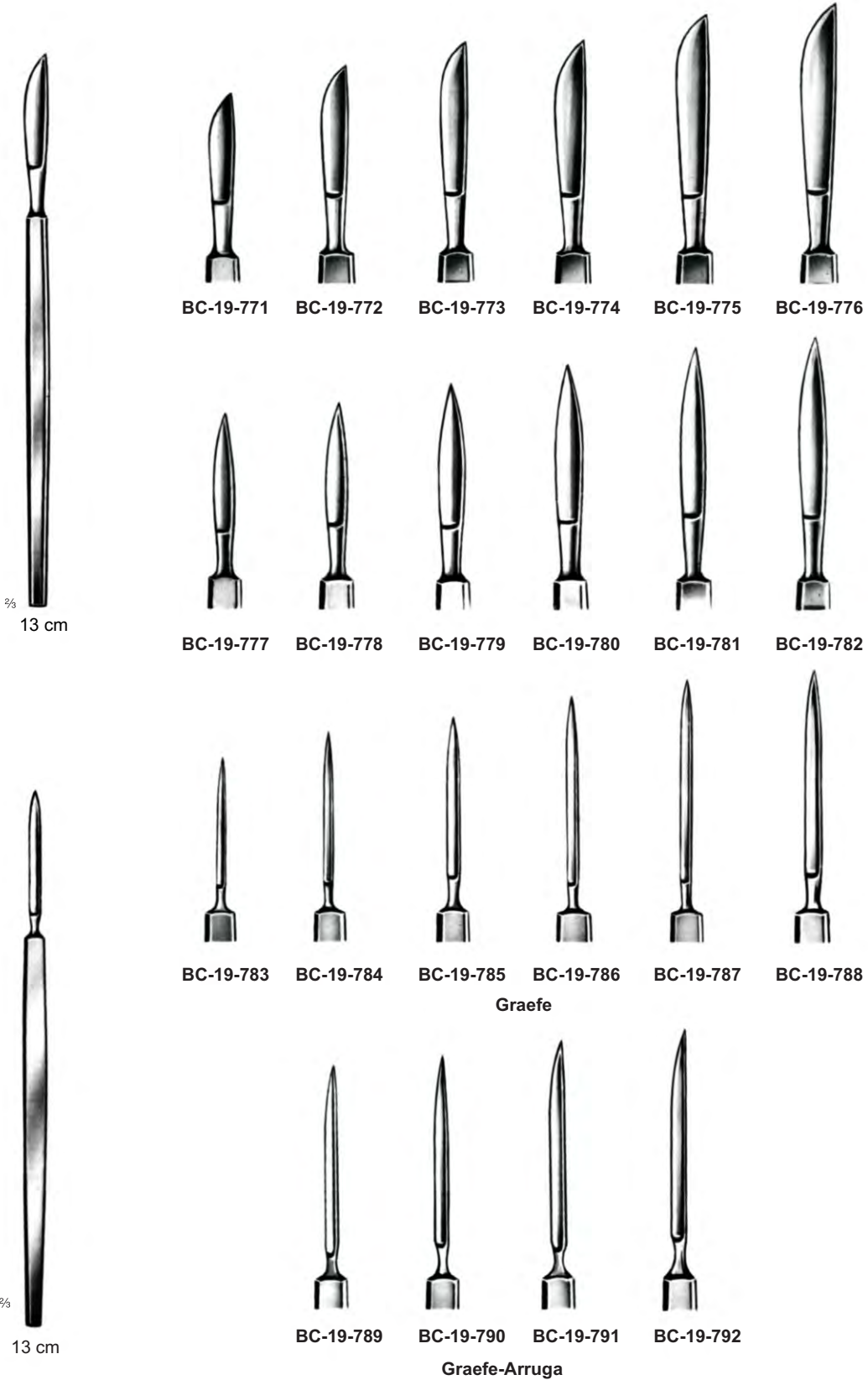



**Graefe**  
BC-19-793



**Deutschmann**  
BC-19-794



**Schmith-Green**  
BC-19-795 BC-19-796



**Berens**  
BC-19-797A

Right curved  
curvo derecha  
courbe a droite



**Wheeler**  
BC-19-798  
18 x 1 mm

Left curved  
curvo izquierda  
courbe a' gauche

**Keratomes**  
Cuchillos lanceolares (Querátomos)

**Couteaux lancéolaires (Keratomes)**



**Jaeger**  
13 cm



BC-19-799



BC-19-800



BC-19-801



BC-19-802



BC-19-803



BC-19-804



BC-19-805



BC-19-806



BC-19-807



BC-19-808



BC-19-809

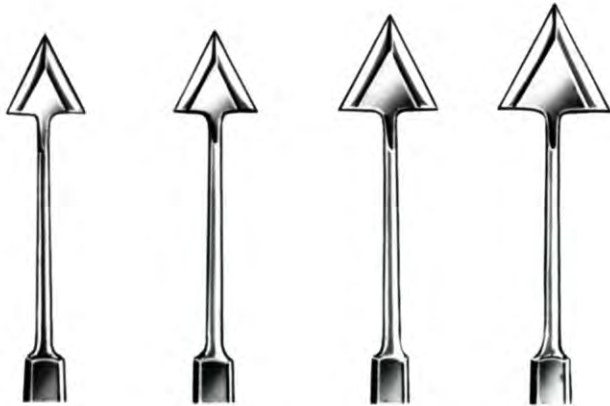

BC-19-810 BC-19-811 BC-19-812 BC-19-813

Jaeger-Grieshaber



BC-19-814 BC-19-815 BC-19-816 BC-19-817

Jaeger-Grieshaber



BC-19-818 4 mm BC-19-819 5 mm BC-19-820 6 mm BC-19-821 7 mm

Wessely-Grieshaber  
curvature - curvatura - courbure 45°



Wiener  
BC-19-822



Berens  
BC-19-823



Berens  
BC-19-824



Papst  
BC-19-825

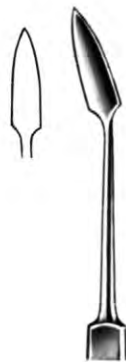

Castroviejo  
BC-19-826  
4 x 13 mm



Wecker  
BC-19-827



Wecker  
BC-19-828



Wecker  
BC-19-829



Wecker  
BC-19-830



Rowland  
BC-19-831



Mod. Tübingen  
BC-19-832



Graefe  
BC-19-833



Schnaudigl  
BC-19-834



Weber  
BC-19-835



Weber  
BC-19-836



Weber  
BC-19-837



Mod. Hamburg



Bowman  
BC-19-838  
0.4 mm



Bowman  
BC-19-839  
0.5 mm



Bowman  
BC-19-840  
0.6 mm



Bowman  
BC-19-841  
0.7 mm



Bowman  
BC-19-842  
0.8 mm



Bowman  
BC-19-843  
0.9 mm



Bowman  
BC-19-844  
1.0 mm



Bowman  
BC-19-845  
left  
derecha  
à gauche



Bowman  
BC-19-846  
right  
à droite



Bowman  
BC-19-847



Knapp  
BC-19-848



Knapp  
BC-19-849



Knapp  
BC-19-850



Ziegler  
BC-19-851  
5 mm



Ziegler  
BC-19-852  
6 mm



Ziegler  
BC-19-853  
7 mm



Kuhnt  
BC-19-854



Kuhnt  
BC-19-855



Ziegler  
BC-19-856  
3 1/2 mm



Sato  
BC-19-857



Dean  
13 cm



Sichel  
BC-19-858



BC-19-859



Johnson  
BC-19-860



Haab  
BC-19-861



Graefe  
BC-19-862



BC-19-863



Graefe  
BC-19-864



Kuhnt  
BC-19-865



Kuhnt  
BC-19-866



Kuhnt  
BC-19-867



Kuhnt  
BC-19-868



**Elschnig**  
 BC-19-869



**Johnson-Took**  
 BC-19-870



**Took**  
 BC-19-871



**Desmarres**  
 BC-19-872



**Desmarres**  
 BC-19-873



**Desmarres**  
 BC-19-874



**Gill**  
 BC-19-875



**Graefe**  
 BC-19-876



**Paton**  
 13 cm



**Wecker**  
 BC-19-877



**Axenfeld**  
 BC-19-878



**Axenfeld**  
 BC-19-879



Walker-Lee  
BC-19-880



Guthrie  
BC-19-881



Elschnig  
BC-19-882



McReynolds  
BC-19-883



Anderson-Critchett  
BC-19-884



Lundsgaard  
BC-19-885



Guyton-lundsgaard  
BC-19-886



Curdy  
BC-19-887



Barraquer  
BC-19-888



Johnson  
BC-19-889



Barkan  
BC-19-890



Scheie  
BC-19-891



Searcy  
BC-19-892



Burch  
BC-19-893



BC-19-894



BC-19-895



BC-19-896



BC-19-897



Daily  
BC-19-898



Desmarres  
BC-19-899



Desmarres  
BC-19-900





**Bowman**  
BC-19-901



**Bowman**  
BC-19-902



**Schweigger**  
BC-19-903



**Schweiz-Mod.**  
BC-19-904



BC-19-905



BC-19-906



**Levinson**  
BC-19-907



**Alvis**  
BC-19-908



**Francis**  
BC-19-909



**La Force**  
(Golf-Club)  
BC-19-910



**Dix**  
BC-19-911



**Ellis**  
BC-19-912



**Plange**  
BC-19-913



**Nicati**  
BC-19-914



**Walton**  
BC-19-915

**Round, Hollow Handle Forceps**

**BC-19-916**

Length: 14 cm / 5½"

Tips: straight 0.15 mm



Tip Profile

1/1

**Round, Hollow Handle Forceps**

**BC-19-917**

Length: 14 cm / 5½"

Tips: straight 0.15 mm tips  
with tying platform



Tip Profile

1/1

**Round, Hollow Handle Forceps**

**BC-19-918**

Length: 14 cm / 5½"

Tips: straight 0.3 mm tips  
with tying platform



Tip Profile

1/1

**Round, Hollow Handle Forceps**

**BC-19-919**

Length: 15 cm / 6"

Tips: 0.15 mm tips  
bent at 45°



Tip Profile

1/1

**Round, Hollow Handle Forceps**

**BC-19-920**

Length: 15 cm / 6"

Tips: straight 0.15 mm



Tip Profile

1/1

**Round, Hollow Handle Forceps**

**BC-19-921**

Length: 15 cm / 6"

Tips: curved 0.3 mm



Tip Profile

1/1

**Dilator Forceps**

**BC-19-922**

Length: 14 cm / 5½"

Tips: straight 0.15 mm tips



Tip Profile

1/1



**Microintraocular forceps**

**BC-19-923**

Length: 14 cm / 5½"

Jaws: 2.5 x 0.3 x 0.25 mm (lwxwt), 1.5 mm maximum opening



1/1

**BC-19-924**

Length: 14 cm / 5½"

Jaws: 3 x 0.6 x 0.4 mm (lwxwt), 1.4 mm maximum opening



Tip Profile:

**Scissors**

**BC-19-925**

14 cm / 5½"

Round hollow handles  
curved blades



1/1



Tip Profile:

**Scissors**

**BC-19-926**

14 cm / 5½"

Round hollow handles  
straight blades



1/1

**Microintraocular scissors**

**BC-19-927**

14 cm / 5½"

30° angled blades



1/1



Tip Profile:

**Microintraocular Scissors**

**BC-19-928**

14 cm / 5½"

35° angled blades



1/1



Tip Profile:

**Needle Holder**

**BC-19-929**

12.5 cm / 5" Long  
round handle  
0.4 mm tips  
curved smooth jaws



**Stevens Needle Holder**

**BC-19-930**

13 cm / 5" Long  
Straight 1 mm wide serrated tips



**Needle Holder**

**BC-19-931**

14 cm / 5½" Long  
round hollow handle  
Straight smooth jaws



**Needle Holder**

**BC-19-932**

14 cm / 5½" Long  
round hollow handle  
curved smooth jaws



**Razor Blade Holder**

**BC-19-933**

12.5 cm / 5" Long  
round tips  
S-Shaped jaw



Special jaw shape prevents blades from slipping

**Razor Blade Holder**

**BC-19-934**

12 cm / 4¾" Long  
round tips  
convex/concave jaws





**BC-19-936**

Castroviejo corneal scissors, 12 cm long curved, blunt tips, small and thin blades cuts 6/0 traction suture, round handles



1/1

**BC-19-937**

Vannas scissors, 11 cm / 4.3" Long, straight, 13 mm blades, sharp points.



1/1

**BC-19-938**

Vannas scissors, 10.5 cm / 4" Long, angled, sharp tips, 10.5 mm blades



1/1

**BC-19-939**

McPherson-Westcott stitch scissors, 11.5 cm / 4½" Long, very sharp pointed tips, small blades, flat handle.



1/1

**BC-19-940**

Westcott stitch scissors, 11cm / 4.3" Long, very sharp pointed tips, standard blades, flat handle.



1/1

**BC-19-941**

McPherson-Westcott scissors, 11 cm / 4.3" Long, curved blunt tips, small blades, and cutting 4-0 suture, flat handles.



1/1

**BC-19-942**

Westcott tenotomy scissors, 11.5 cm / 4½" Long, curved blunt tips, standard blades, flat right handles.



1/1

**BC-19-943**

Conjunctival scissors, 12 cm / 4¾" Long, round handle, curved, blunt tips, small blades



1/1

**BC-19-944**

Iris scissors, 10.5 cm / 4" Long, curved



**BC-19-945**

Vannas scissors, 11 cm / 4.3" Long, straight sharp tips, 10.5 mm blades



**BC-19-946**

Castroviejo scissors, 11 cm / 4.3" Long, small blades, cuts 4/0 suture, angled left.



**BC-19-947**

Castroviejo scissors, 11 cm / 4.3" Long, small blades, cuts 4/0 suture, angled right



**BC-19-948**

Castroviejo scissors, 12 cm / 4 3/4" Long, strong curve, round handles,



**BC-19-949**

Castroviejo corneal scissors, 12 cm / 4 3/4" Long, curved, blunt tips, medium blades, cuts 4/0 suture, round handles,



**BC-19-950**

Vannas scissors, 10.5 cm / 4") Long, curved, sharp tips, 12.5 mm blades.



**BC-19-951**

Vannas scissors, 10.5 cm / 4") Long, curved, sharp tips, 10.5 mm blades.



**BC-19-952**

Needle holder, 12 cm / 4¾" Long,  
curved, standard range, without lock.



**BC-19-953**

Needle holder, 12 cm / 4¾" Long,  
curved, standard range, with lock.



**BC-19-954**

Barraquer Needle holder, 12 cm / 4¾" Long,  
curved, without lock.



**BC-19-955**

Barraquer Needle holder, 12 cm / 4¾" Long,  
curved, with lock.



**BC-19-956**

Troutman Needle holder, 12 cm / 4¾" Long,  
10 mm light curved jaws, without lock.



**BC-19-957**

Troutman Needle holder, 12 cm / 4¾" Long,  
10 mm light curved jaws, with lock.



**BC-19-958**

Blade Breaker, 12.5 cm / 5" Long,



**BC-19-959**

Tying forceps, standard range, 11.5 cm / 4½"  
Long, straight, 0.25 x 0.15 mm tips,  
with 4 mm long tying platform.



1/1

**BC-19-960**

Tying forceps, ultra fine range, 11.5 cm / 4½"  
Long, straight, 0.25 x 0.15 mm  
tips, with 4 mm long tying platform.



1/1

**BC-19-961**

McPherson Tying forceps, 11.5 cm / 4½"  
Long, 45° angled, 12 mm shafts,  
0.25 x 0.15 mm tips, with 4 mm  
long tying platform.

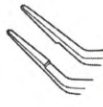

1/1

**BC-19-962**

McPherson Tying forceps, 11.5 cm / 4½"  
Long, 45° angled, 12 mm shafts,  
0.25 x 0.15 mm tips, with 4 mm  
long tying platform.



1/1

**BC-19-963**

Notched forceps, 8.5 cm / 3¼" Long,  
straight, 1 x 1 teeth, with tying platform,  
standard range.

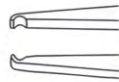

1/1

**BC-19-964**

Notched forceps, 11.5 cm / 4½" Long,  
1 x 1 teeth, with tying platform,  
standard range, straight.

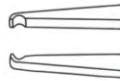

1/1

**BC-19-965**

Notched forceps, 11.5 cm / 4½" Long,  
1 x 1 teeth, with tying platform,  
ultra fine range, straight.

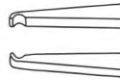

1/1

**BC-19-966**

Pierse-Colibri corneal forceps, 7.5 cm / 3" Long fine,  
1 x 1 pierse teeth, with tying platform.



1/1





**BC-19-967**

Colibri suturing fine forceps, 7.5 cm / 3" Long, 140° toothed (1x2 teeth), 0.1 mm, with tying platform.

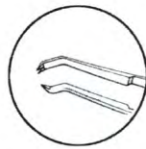

1/1

**BC-19-968**

Suturing forceps, ultra fine range, 8.5 cm / 3¼" Long, straight, 140° toothed (1x2 teeth), 0.12 mm with tying platform.

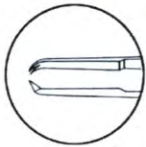

1/1

**BC-19-969**

Colibri Suturing forceps, 8.5 cm / 3¼" Long, 140° very delicate toothed (1x2 teeth), 0.10 mm, with tying platform.

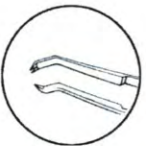

1/1

**BC-19-970**

Suturing forceps, ultra fine range, 11.5 cm / 4½" Long, Straight, 140° toothed (1x2 teeth), 0.12 mm, with tying platform.



1/1

**BC-19-971**

McPherson 90° toothed forceps, 8.5 cm / 3¼" Long, 45° angled, 12 mm straight shafts, 1x2 teeth, 0.10 mm, with tying platform.



1/1

**BC-19-972**

Colibri forceps, 8.5 cm / 3¼" Long, 90° toothed, (1x2 teeth), 0.12 mm, with tying platform.



1/1

**BC-19-973**

90° toothed forceps, 11.5 cm / 4½" Long, 0.12mm, 1 x 2 teeth, straight, with tying platform.



1/1

**BC-19-974**

90° toothed forceps, 11.5 cm / 4½" Long, 1x2 teeth, straight, 0.10 mm, with tying platform.



1/1

**BC-19-975**

Colibri 90° toothed forceps, 11.5 cm / 4½" Long, 1x2 teeth, 0.10 mm, with tying platform.



1/1

**BC-19-976**

Kelman- McPherson forceps, 8.5 cm / 3¼" Long, 45° angled, very delicate, 7.5 mm long smooth platform



1/1

**BC-19-977**

Kelman-McPherson forceps, 11.5 cm / 4½" Long, 45° angled, very delicate, 7.5 mm long smooth platform



1/1

**BC-19-978**

Claymans type 10L forceps, 10.5 cm / 4" Long,



1/1

**BC-19-979**

10L forceps, with thin ring tips, 10.5 cm / 4" Long,



1/1

**BC-19-980**

Jaffe-Blaydes 10L forceps, 10.5 cm / 4" Long,



1/1

**BC-19-981**

Kelman-McPherson Style lens holding forceps, 11.5 cm / 4½" Long, round smooth jaws for holding soft 10Ls.



1/1

**BC-19-982**

Lens implantation forceps for holding soft 10Ls, 11.5 cm / 4½" Long, The jaw s' smooth surfaces and rounded edges grip the lens firmly and gently.



1/1

**BC-19-983**

Direct action Lens implantation forceps for holding soft acrylic 10Ls, 12 cm / 4¾" Long, curved jaws, without lock, round handles.



1/1



**BC-19-984**

Direct action lens implantation forceps for holding soft acrylic 10Ls, 12 cm / 4¾" Long, curved jaws, with lock, round handle.



**BC-19-985**

Capsulorhexis forceps, 8.5 cm / 3¼" Long, Cystotome tips, extremely thin and straight shanks, flat handles.



**BC-19-986**

Capsulorhexis forceps, 8.5 cm / 3¼" Long, Cystotome tips, recessed inside jaw surfaces, extremely thin and vaulted shanks, flat handle.



**BC-19-987**

Capsulorhexis forceps, 11.5 cm / 4½" Long, Cystotome tips, recessed inside jaw surfaces, extremely thin and vaulted shanks, flat handle.



**BC-19-988**

Capsulorhexis forceps, 10.5 cm / 4" Long, recessed inside jaw surfaces, extremely thin and vaulted shanks with guide pin, round handle.



**BC-19-989**

Capsulorhexis forceps, 12 cm / 4¾" Long, 12 mm blades, gap between blades, Tongue and groove iris stop, extremely thin and straight shanks, round handle.



**BC-19-990**

Capsulorhexis forceps, 12 cm / 4¾" Long, 12 mm blades, gap between blades, Tongue and groove iris stop, vaulted and extremely thin and curved shanks, round handle.



**BC-19-991**

Capsulorhexis notched forceps, 8.5 cm / 3¼" Long, platform at tips, recessed inside jaw surfaces, extremely thin and vaulted shanks, flat handle.



**BC-19-992**

Capsulorhexis notched forceps, 11.5 cm / 4½" Long, platform at tips, recessed inside jaw surfaces, extremely thin and vaulted shanks, flat handles.



**BC-19-993**

Hofmann-Polack corneal suturing forceps, 11.5 cm / 4½" Long, 45° angled, 1 mm spread, 1x1 pierse teeth, 0.25 mm



**BC-19-994**

Polack corneal suturing forceps, 11.5 cm / 4½" Long, 45° angled, 1 mm spread, very delicate, 1x2 teeth, 0.12 mm



1/1

**BC-19-995**

Lieberman LASIK solid speculum 7.5 cm / 3" Long, with 12.5 mm Long blades and maximum spread of 3 cm.



1/1

**BC-19-996**

Machat LASIK adjustable wire speculum 8 cm / 3" Long with 14.5 mm blades and maximum spread of 3.5 cm.



1/1

**BC-19-997**

Adjustable wire speculum 6.5 cm / 2½" Long, maximum spread of 2.2 cm.

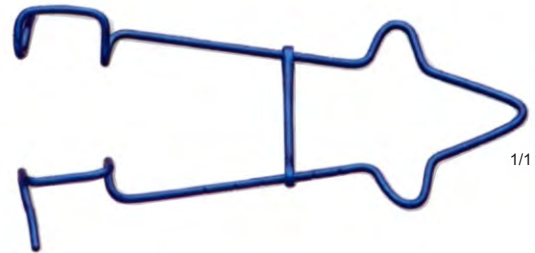

1/1

**BC-19-998**

Wire speculum 4.5 cm / 1¾" Long, with 13.5 mm blades and maximum spread of 20 cm.

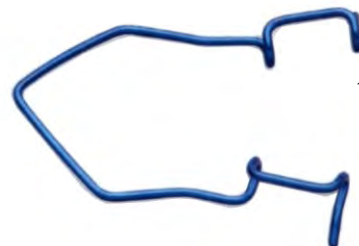

1/1



**BC-19-999**

Lens nucleus rotator, 12 cm / 4¾" Long, V-shaped tips, angled



1/1

**BC-19-1000**

Gass muscle hook, 12.5 cm / 5" Long, with oval hole, 10 mm long.



1/1

**BC-19-1001**

Fenzl lens manipulator, 12 cm / 4¾" long, T-shaped tip, angled.



1/1

**BC-19-1002**

Button manipulator, 11.5 cm / 4 ½" Long



1/1

**BC-19-1003**

Haefliger phaco cleaver, 12 cm / 4¾" Long



1/1

**BC-19-1004**

Kansas nucleus vectis, 12.5 cm / 5" Long



1/1

**BC-19-1005**

Akahoshi nucleus sustainer, 11.5 cm / 4½" Long



1/1

**BC-19-1006**

Phaco claw chopper, 11 cm / 4.3" Long straight



1/1

**BC-19-1007**

Nichamin Phaco triple chopper, 12 cm / 4¾" Long, angled, rounded and highly polished distal tip, straight shank.



1/1

**BC-19-1008**

Minami "M" hook, 11.5 cm / 4½" Long



1/1

**BC-19-1009**

Corneal Epithelium Spatulae, 11 cm / 4.3" Long



1/1

**BC-19-1010**

Lester 10L manipulator, 12 cm / 4¾" Long, vaulted shank, angled



1/1

**BC-19-1011**

Jaffe-Knolle Iris hook, 11.5 cm / 4½" Long, very blunt, small, angled.



1/1

**BC-19-1012**

Sinskey lens manipulating hook 12 cm / 4¾", Long, 0.15 mm dia blunt tip, Straight shank, angled to right.



1/1

**BC-19-1013**

Lewicky lens manipulating hook, 12 cm / 4¾" Long, 0.15 mm dia blunt tip, vaulted shank, angled to right.



1/1

**BC-19-1014**

Rentsch "Boat hook" lens manipulator, 11 cm / 4.3" Long,



1/1

**BC-19-1015**

Synechia spatula, 12 cm / 4¾" Long, smooth, 0.70 mm wide.



1/1

**BC-19-1016**

Kansas nucleus bisector, 11 cm / 4.3" Long, for manual small incision surgery.



1/1

**BC-19-1017**

Kansas nucleus trisector, 10 cm / 4" Long



1/1

**BC-19-1018**

Lens loop, 12 cm / 4¾" Long, 3 mm wide, serrated



1/1

**BC-19-1019**

Connor intracapsular manipulator, 12 cm / 4¾" Long, straight shank



1/1

**BC-19-1020**

Neuliann nucleus divider and manipulator, 11 cm / 4.3" Long



1/1



**WELMED Instrument Company  
Defence Road, Near Wapda Grid Station  
Sialkot 51310, Pakistan.**

**Phone : +92 52 3554782, 3558704**

**Fax : +92 52 3550296**

**📞 Mobile : +92 333 8680640**

**Email : [welmedpk@gmail.com](mailto:welmedpk@gmail.com)**

**[info@welmedinst.com](mailto:info@welmedinst.com)**

**[wmm@brain.net.pk](mailto:wmm@brain.net.pk)**

**[welmed@cyber.net.pk](mailto:welmed@cyber.net.pk)**

**Website : [www.welmedinst.com](http://www.welmedinst.com)**