



Micro Instruments

26

WELMED Instruments Company
Defence Road
Near Wapda Grid Colony
Sialkot 51310, Pakistan.

Phone : +92 52 3554782, 3558704
Fax : +92 52 3550296
Cell : +92 333 8680640

Email : info@welmedinst.com
welmedpk@gmail.com
wmm@brain.net.pk
welmed@cyber.net.pk

Website : www.welmedinst.com

About Us

Quality begins at **WELMED** Instruments Company where master craftsmen forge and manufacture each instrument to its exact specifications and measurements. Instruments must undergo a series of quality control inspections in order to be worthy of **WELMED** name and warranty. We offer a wide selection of medical instruments including Surgical and Dental instruments.

We have acquired a unique and unmatched understanding of manufacturing through a large experience, working since 1908. Years of experience & state of the art manufacturing facilities helped us to keep our prices low. Our Surgical & Dental instruments are created by expert craftsmen, providing unfaltering quality you can rely on.

We have launched a fully interactive website where you can get online and track your orders 24 hours a day, 7 days in a week, and 365 days a year. Ask for our free e-catalogue on CD-Rom to save time and enjoy hassle free ordering.

We provide our customers with most reliable customer service as your satisfaction is our top priority. Our customers always enjoy our wonderful customer service and quality tools at the best price.

Lastly we invite you to have a work experience with **WELMED** Instruments Company and we will prove ourselves as one of the most valuable source you have.

You can find us at

WELMED Instruments Company
Defence Road, Near Wapda Grid Colony
Sialkot 51310, Pakistan.

Phone : +92 52 3554782, 3558704
Fax : +92 52 3550296
Cell : +92 333 8680640

Emails :
Info@welmedinst.com
welmedpk@gmail.com
wmm@brain.net.pk
welmed@cyber.net.pk

Website : www.welmedinst.com



History

WELMED Instruments Company was founded in 1995. Our Great Grandfather **Mian Muhammad Fazal Elahi** was the founder of M/s M.F. Elahi & Company (E.P.) Pvt. Ltd, established in 1908. WELMED is a sister concern of M.F.Elahi & Co. It is our pride to be a member of M.F. Elahi Family.

WELMED Instruments Company is located in the heart of beautiful city, Sialkot, Pakistan. We are manufacturers and exporters of quality Surgical, Dental instruments and Scissors of all sorts in various categories. We are closely attached with highly skilled surgeons and other technicians of the surgical industry to make the new instruments development possible.

WELMED is in a continuous process of development and testing of new instruments for their precision and perfect functioning. We are also working at imported forging supply by foreign customers.

Certificates

Welmed Instruments Company has achieved the certificates for ISO-9001, ISO-13485, cGMP (FDA) and CE Marking.

Quality Control

All material used in the manufacturing of our instruments are tested from relevant laboratories. Our continuous quality control is our best warranty so that you built confidence in our products.

Deliveries

Deliveries are quick and in-time.

Mode Of Payment

Terms of Payment is ADVANCE or LETTER OF CREDIT (Irrevocable)

Quality Policy

WELMED Instruments Company aims to produce quality Surgical, Dental instruments and Scissors of all sorts at reasonable prices to become an exemplary manufacturer. Our total emphasize is to achieve customer's satisfaction by clearly understanding their requirements and following a quality management system which is a primary concern of all our work force. We do our best to produce instruments of finest quality.



Warranty

All WELMED Instruments are produced from finest stainless steel available to be free from any defect in material or workmanship. Any product that proves to be defective in material or workmanship will either be repaired or replaced without any charge. This warranty is void if the instrument is abused, altered, modified or is not used in the manner for which it is intended.

Micro Instruments 26



WELMED
INSTRUMENTS CO.

Adventitias	97, 99
Baby-Hehemann Scissor	07
Clip Applying Forcep	16
Curette Jaw Toothed Forcep	19
Diethrich Forcep	16
Dissection	97, 99
Debakey	101
Hegemann (Diethrich) Scissor	08
Instruments With Finger Grip Handle	27
Jacobsen Scissor	10
Micro Forcep Jacobson	19
Micro Forcep Yasargil	19
Micro Forcep	17
Micro Forcep	18
Micro Needle Holder Yasargil	23
Micro Needle Holder	20
Micro Needle Holder	21
Micro Needle Holder	22
Micro Needle Holder	24
Micro Needle Holder	25
Micro Needle Holder	26
Micro Scissor Adentita	03-01
Micro Scissor Adventitia	01
Micro Scissor Dissection	01
Micro Scissor Dissection	03-01
Micro Scissor Nerve	03
Micro Scissor Saw Edge	12
Micro Scissor	02
Micro Scissor	04
Micro Scissor	11
Micro Scissor	13
Micro Scissor	14
Micro Scissor	15
Potts-smith Scissor	06
Schwartz Forcep	16
Uascular Scissor De Bekay	05
Vascular Scissor	09
Yasargil Dressing Forcep	16
Yasargil Tumor Grasping Forcep	19

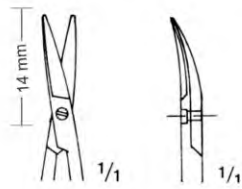

**Dissection
BC-26-651**

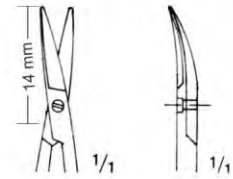

**BC-26-653
Dissection**

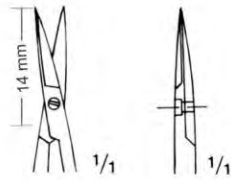

**Adventitia
BC-26-652**

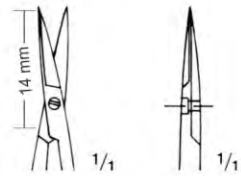

**Adventitia
BC-26-654**



14.5 cm / 5½"



18 cm / 7"

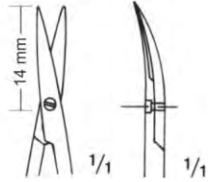

BC-26-655
14.5 cm / 5 1/2"

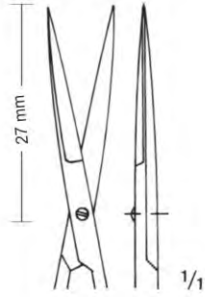

BC-26-656
18 cm / 7"

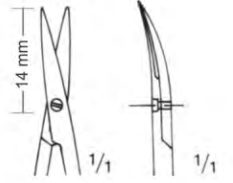

BC-26-657
18 cm / 7"



11 cm / 4½"

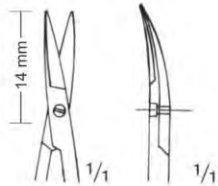

**Dissection
 BC-26-658**

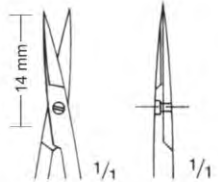

**Adventitia
 BC-2 6-659**



15 cm / 6"

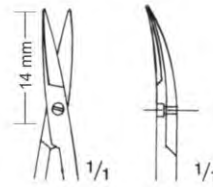

**Dissection
 BC-26-660**

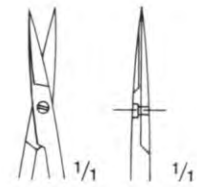

**Adventitia
 BC-26-661**

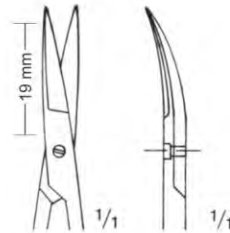

**Dissection
 BC-26-662**

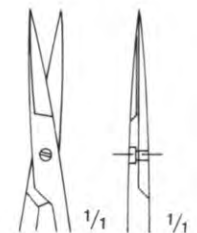

**Adventitia
 BC-26-663**

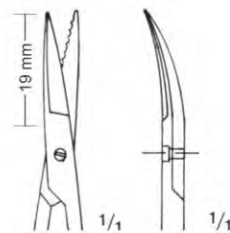

**Dissection
 BC-26-664**

Nerve

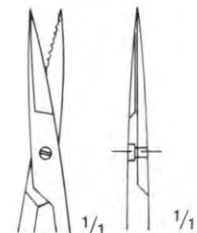

**Adventitia
 BC-26-665**



18.5 cm / 7 1/4"

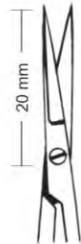

BC-26-666



BC-26-667



BC-26-668
BC-26-669
BC-26-670



BC-26-671
BC-26-672
BC-26-673

16 cm / 6 1/4"
20 cm / 8"
22.5 cm / 9"



BC-26-674
BC-26-675
BC-26-676



BC-26-677
BC-26-678
BC-26-679



BC-26-680
BC-26-681
BC-26-682



BC-26-683
BC-26-684
BC-26-685

16 cm / 6 1/4"
20 cm / 8"
22.5 cm / 9"

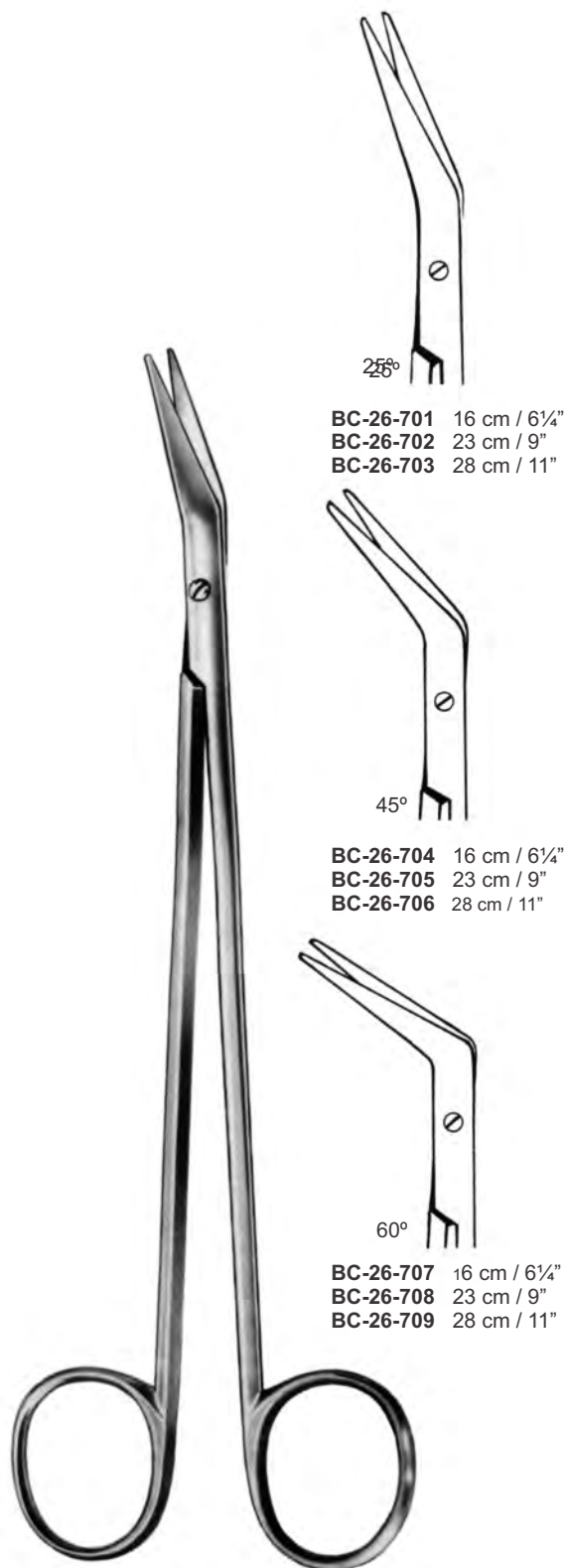

DeBakey

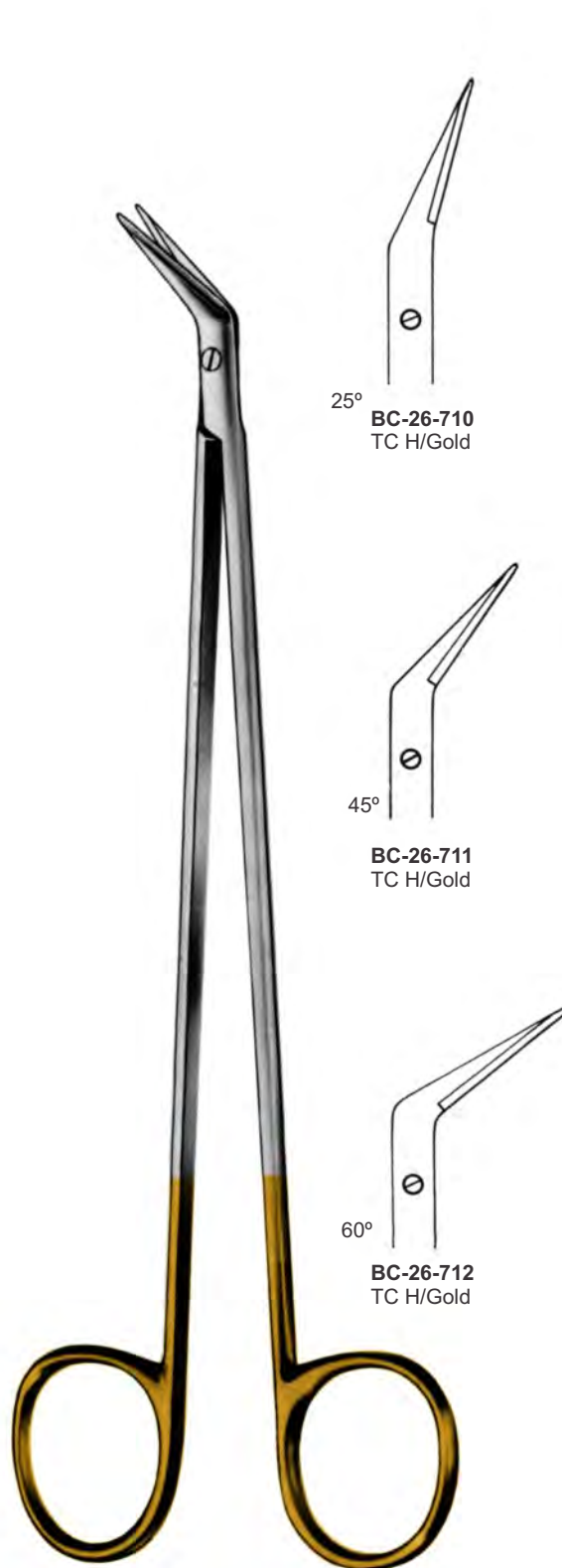

DeBakey
 18 cm / 7"

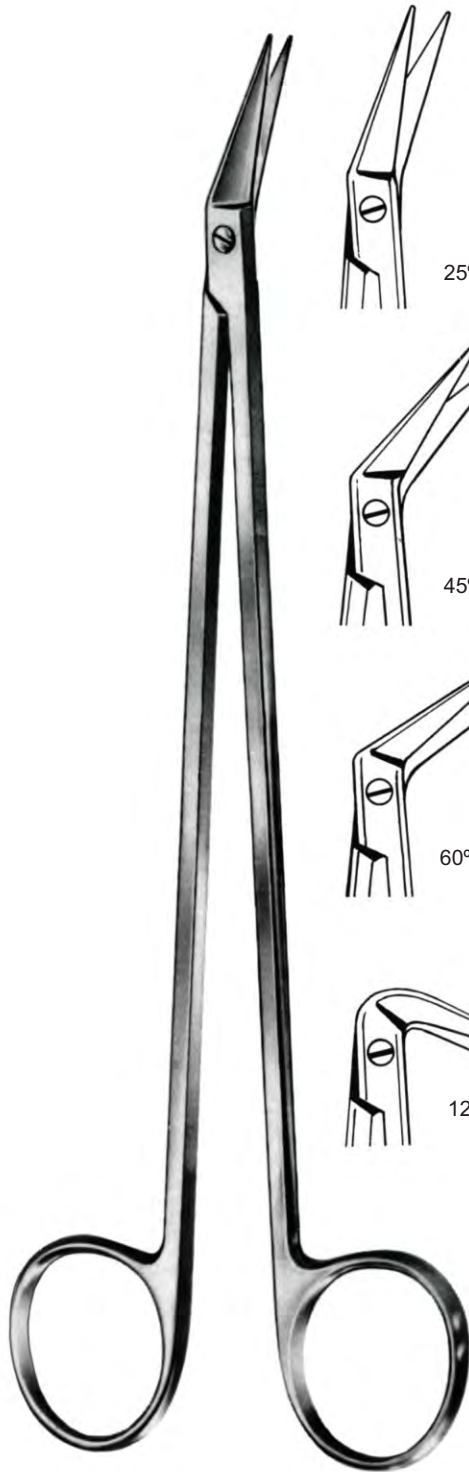

25° BC-26-713



45° BC-26-714

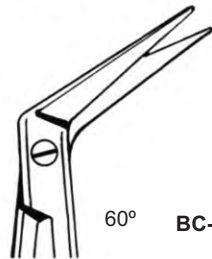

60° BC-26-715

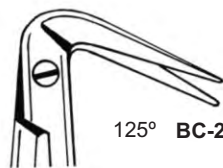

125° BC-26-716

Potts-Smith
19 cm / 7½"

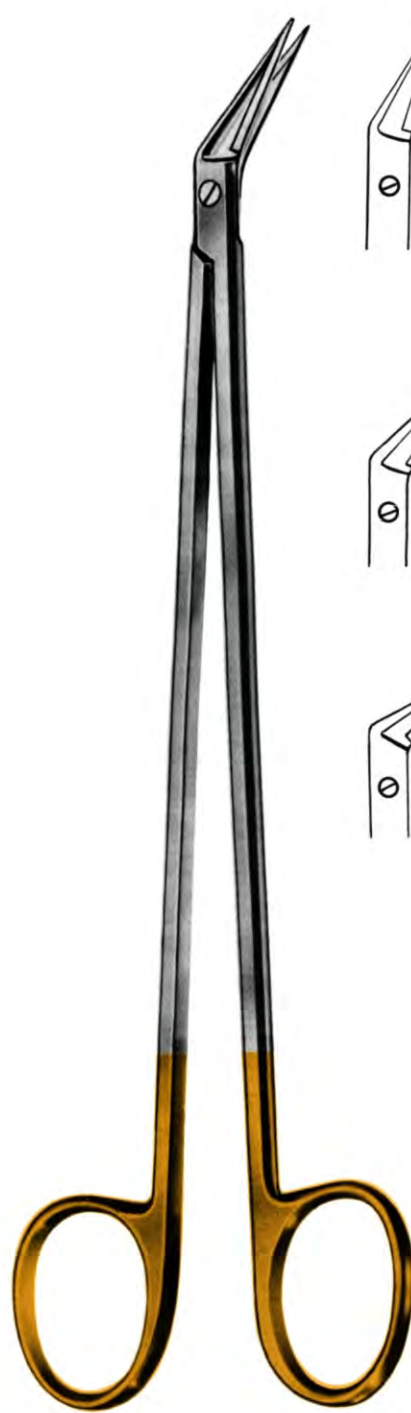

25° BC-26-717
TC H/Gold

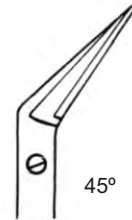

45° BC-26-718
TC H/Gold

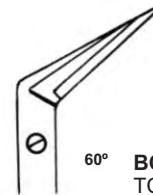

60° BC-26-719
TC H/Gold

Potts-Smith
19 cm / 7½"

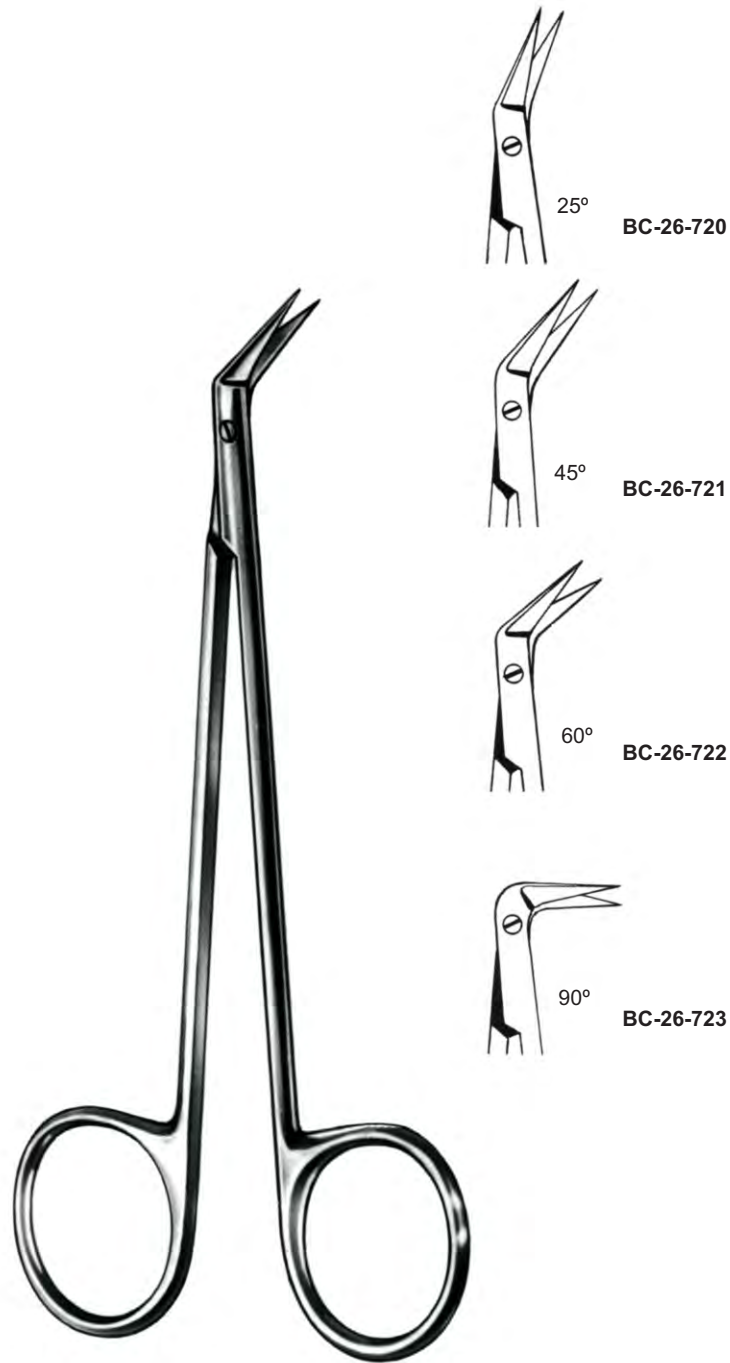

Baby-Hegemann
13.5 cm



25° **BC-26-724** 19 cm / 7½"
BC-26-724A 16 cm / 6¼"

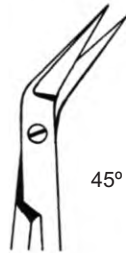

45° **BC-26-725** 19 cm / 7½"
BC-26-725A 16 cm / 6¼"

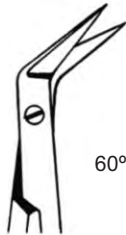

60° **BC-26-726** 19 cm / 7½"
BC-26-726A 16 cm / 6¼"

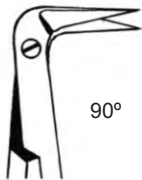

90° **BC-26-727** 19 cm / 7½"
BC-26-727A 16 cm / 6¼"



125° **BC-26-728** 19 cm / 7½"
BC-26-728A 16 cm / 6¼"

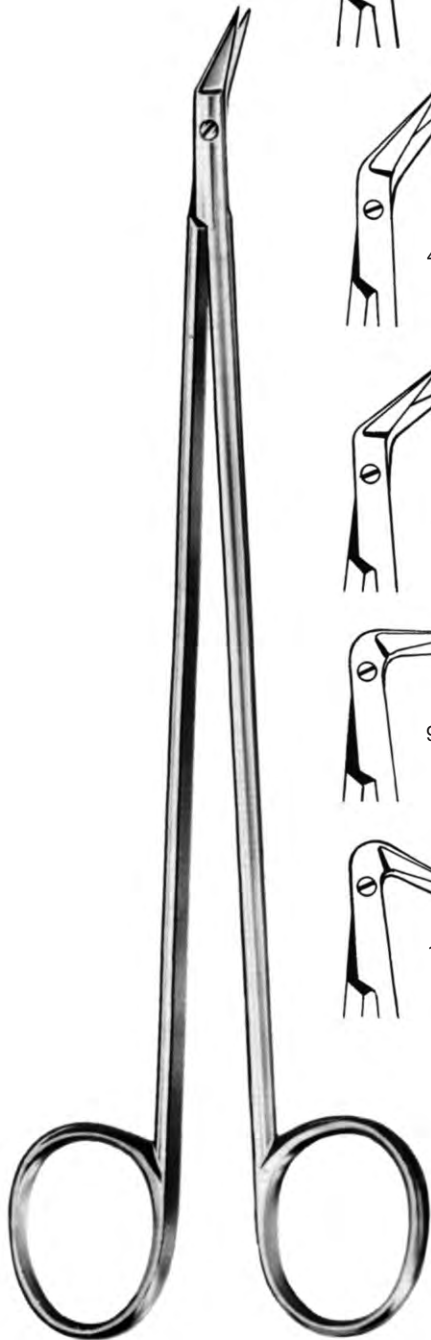

**Hagemann
(Diethrich)**



BC-26-729
19 cm / 7½"



18 cm / 7"

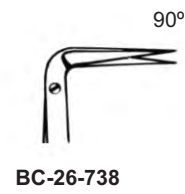
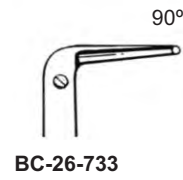



Jacobson
18 cm / 7"



BC-26-740



BC-26-743



BC-26-741



BC-26-744



BC-26-742



BC-26-745



Jacobson
19 cm / 7 1/2"



BC-26-746
12 cm / 4¾"
straight
rectas
droits

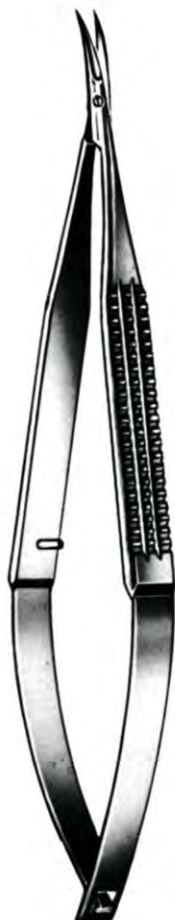

BC-26-747
12 cm / 4¾"
curved
curvas
courbes

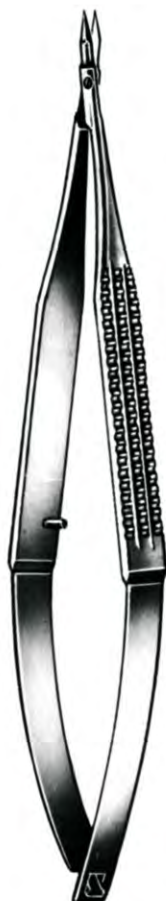

BC-26-748
12 cm / 4¾"
straight
rectas
droits



BC-26-749
12 cm / 4¾"
curved
curvas
courbes



BC-26-750
12 cm / 4¾"
angled up
acodadas hacia arriba
coudes vers le haut



Saw edge
dentadas
dentele's



BC-26-751
16 cm / 6¼"
straight
rectas
droits

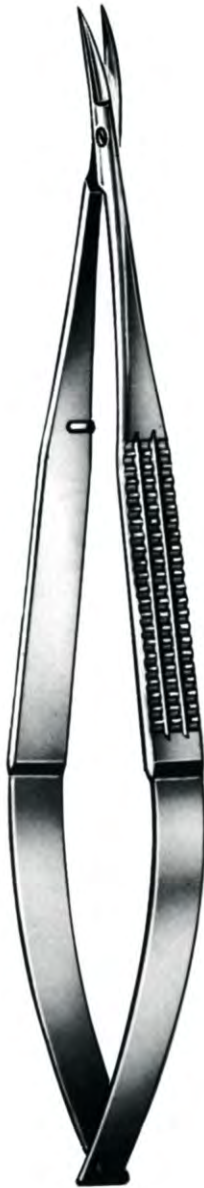

BC-26-752
16 cm / 6¼"
curved
curvas
courbes



BC-26-753
16 cm / 6¼"
straight
rectas
droits

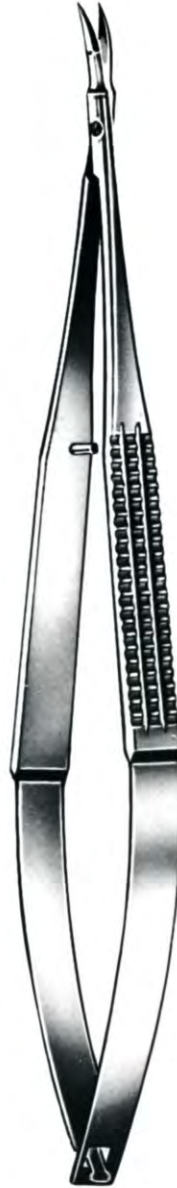

BC-26-754
16 cm / 6¼"
curved
curvas
courbes



BC-26-755
16 cm / 6¼"
straight
rectas
droits



BC-26-756
16 cm / 6¼"
curved
curvas
courbes



BC-26-757
18.5 cm / 7¼"
straight
rectas
droits



BC-26-758
18.5 cm / 7¼"
curved
curvas
courbes

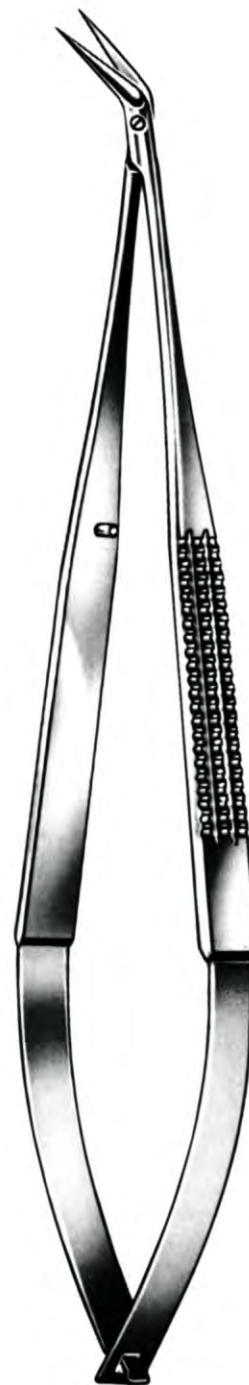

BC-26-759
18.5 cm / 7¼"
angular
acodadas
coudes



Saw edge
dentadas
denteles



BC-26-760
16 cm / 6¼"
Straight
rectas
droits



BC-26-761
16 cm / 6¼"
Curved
curvas
courbes



BC-26-762
16 cm / 6¼"
Straight
rectas
droits



BC-26-763
16 cm / 6¼"
Curved
curvas
courbes



BC-26-764
16 cm / 6¼"
Straight
rectas
droits



BC-26-765
16 cm / 6¼"
Curved
curvas
courbes



BC-26-766
18.5 cm / 7 1/4"
straight
rectas
droits



BC-26-767
18.5 cm / 7 1/4"
curved
curvas
courbes



BC-26-768
18.5 cm / 7 1/4"
angular
acodadas
coudes



Yasargil
BC-26-769
18.5 cm / 7¼"
slightly curved
curva ligeramente
courbure legere



Yasargil
BC-26-770
18.5 cm / 7¼"
strong curved
mas curva
courbure forte



Schwartz
19 cm / 7½"



BC-26-771



BC-26-772



BC-26-773



Diethrich



8 mm

BC-26-774



12 mm

BC-26-775



16 mm

BC-26-776



8 mm

BC-26-777

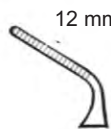

12 mm

BC-26-778

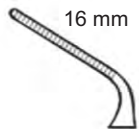

16 mm

BC-26-779



BC-26-780
14 cm / 5¼"



BC-26-781 18 cm / 7"
BC-26-782 22 cm / 8½"



BC-26-784
15 cm / 6"
straight
rectas
droits



BC-26-785
18 cm / 7"
straight
rectas
droits



BC-26-786
12 cm / 4¾"
straight
rectas
droits



BC-26-787
12 cm / 4¾"
curved
curvas
courbes



BC-26-788
15 cm / 6"
straight
rectas
droits



BC-26-789
15 cm / 6"
curved
curvas
courbes



BC-26-790
18 cm / 7"
straight
rectas
droits



BC-26-791
18 cm / 7"
curved
curvas
courbes

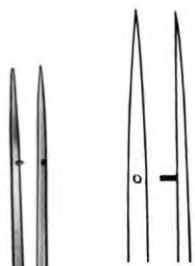

BC-26-792

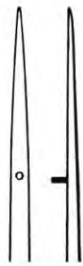

BC-26-793



BC-26-794



Jacobson
 18 cm / 7"

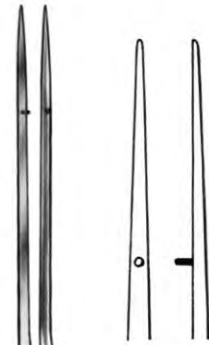

BC-26-795



BC-26-796



Yasargil
 22.5 cm / 8 3/4"



Yasargil
 22 cm / 8 1/2"



BC-26-797 3 mm



BC-26-798 5 mm

Jaw spoon shaped
 Boca en forma de cuchara
 Mors en forme de cuiller



BC-26-799 3 mm



BC-26-800 5 mm

Jaw flat, serrated
 Boca plana, dentada
 Mors plats, dentes



BC-26-801 3 mm



BC-26-802 5 mm

Curette jaw, toothed
 Boca en forma de
 Raspado, dentada
 Mors de forme de currettes



BC-26-803
 18 cm / 7"



BC-26-804
14 cm / 5 1/2"



BC-26-805
14 cm / 5 1/2"
For right handed surgeons
para mano derecha
pour la main droite

Jaw concave/convex
Bocas concavas/convexas
Mors concave/convexe



BC-26-806
14 cm / 5 1/2"
For left handed surgeons
para mano izquierda
pour gaucher



BC-26-807
18 cm / 7 $\frac{1}{4}$ "



BC-26-808
18 cm / 7 $\frac{1}{4}$ "



BC-26-809
18 cm / 7 $\frac{1}{4}$ "



BC-26-810
18 cm / 7 $\frac{1}{4}$ "



BC-26-811
15 cm / 6"
straight
rectas
droits



BC-26-812
15 cm / 6"
curved
curvas
courbes



BC-26-813
18 cm / 7"
straight
rectas
droits



BC-26-814
18 cm / 7"
curved
curvas
courbes



BC-26-815
18 cm / 7"
straight
rectas
droits

Straight
rectas
droits



Yasargil
BC-26-816 18 cm / 7"
BC-26-817 22.5 cm / 9"

Curved
curvas
courbes



Yasargil
BC-26-818 18 cm / 7"
BC-26-819 22.5 cm / 9"



BC-26-820
15 cm / 6"
straight
rectas
droits



BC-26-821
15 cm / 6"
curved
curvas
courbes



BC-26-822
15 cm / 6"
straight
rectas
droits



BC-26-823
15 cm / 6"
curved
curvas
courbes



BC-26-824
18.5 cm / 7¼"
straight
rectas
droits



BC-26-825
18.5 cm / 7¼"
curved
curvas
courbes



BC-26-826
18.5 cm / 7¼"
straight
rectas
droits



BC-26-827
18.5 cm / 7¼"
curved
curvas
courbes



- | | | |
|------------------|------------------|------------------|
| BC-26-828 | 16.5 cm / 6 1/2" | BC-26-832 |
| BC-26-829 | 18 cm / 7" | BC-26-833 |
| BC-26-830 | 20 cm / 8" | BC-26-834 |
| BC-26-831 | 22 cm / 9" | BC-26-835 |



BC-26-836



BC-26-837

Micro Scissors
Micro Tijeras
Micro-ciseaux



BC-26-838



BC-26-839

Micro Forceps
Micro Pinzas
Micro-Pinces



BC-26-840



BC-26-841

Cup-Shaped Forceps
Pinzas en forma de cuchara
Pinzes bec de canard



**WELMED Instrument Company
Defence Road, Near Wapda Grid Station
Sialkot 51310, Pakistan.**

Phone : +92 52 3554782, 3558704

Fax : +92 52 3550296

📞 Mobile : +92 333 8680640

Email : welmedpk@gmail.com

info@welmedinst.com

wmm@brain.net.pk

welmed@cyber.net.pk

Website : www.welmedinst.com