

Heamostatic Forceps 08

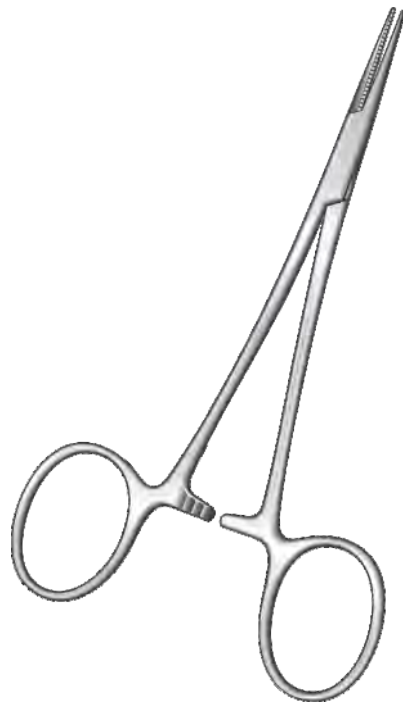

WELMED
INSTRUMENTS CO.

Adson	111	Moynihan	137
Adson-Baby	118	Negus	133
Backhaus	139	Obwegeser	102
Bengolea	114	Organ Grasping Forceps	110
Bernhard	140	Orgen-Grasping	109
Bozemann	147,150	Overholt	122
Carfoord	119	Overholt-Baby	105
Chaput	109	Overholt-Fino	121
Cheron	147	Overholt-Geissendorfer	120
Collin	110,147	Overholt-Martin	117
Crile	104,105	Overholt-Mini	122
Crile-Rankin	101	Overholt-Mixter	118
Dandy	101	Pean	108,112
Dandy-Mosquito	101	Pean (Rochester)	115
Dasjardins	131	Pean-Nippon	113
Dissecting & Ligature Forceps	117,129,132	Peers-Bertram	141
Dressing Forceps	144-147	Peers-Bertram Modif	140
Faure	138	Pennington	110
Finochietto	128	Periosteal Elevators	102
Fletcher (Javerts)	150	Phaneuf	134
Foerster	148,149	Plaster Spreaders	130
Gemini	123	Pratt	110
Gross-Maier	146	Providence-Hospital	107
Guyon	130,131	Rampley	149
Halsted-Mosquito	103	Roberts	119
Hartmann	106	Rochester-Carmalt	111
Hemostatics Forceps	101,103-109,111-116	Roder	140
Heaney	134	Rogers	135
Heiss	118	Rowe	102
Hysterotomy Forceps	133-138	Rumel	121
Jones	139	Sarot	119
Jones-Martin	139	Schadel	139
Kelly	104,107,129	Schnidt	111
Kelly-Rankin	105	Spencer-Wells	108
Kidney Pedical Clamps	131	Spong Forceps	148-149
Kocher	112	Tiffier	109
Kicher- (Ochsner)	116	Tohoku	141
Kocher (Nippon)	113	Towel Clamp	139-141
Lahey	127	Tubing Clamp	142,143
Lane	141	Ulrich	144
Lawrence	132	Uro-Tangential	128
Leriche	107	Utrain Dressing Forceps	150
Lister	145	Wertheim	136,137
Lovlace	101	Wertheim-Cullen	133
Lower	127	Wickstrom	126
Martel-Rees	110	Zenker	124
Martin	145		
Martin-Fuchsig	111		
Mc Quigg-Mixter	127		
Meeker	132		
Mershon	102		
Mikro-Mosquito	103		
Mikulicz	136,138		
Mikulicz, Baby	136		
Mini-Gemini	123		
Mixter	125,126		
Mixter-Baby	106,118,124		
Mixter-o'Shaugnessy	125		

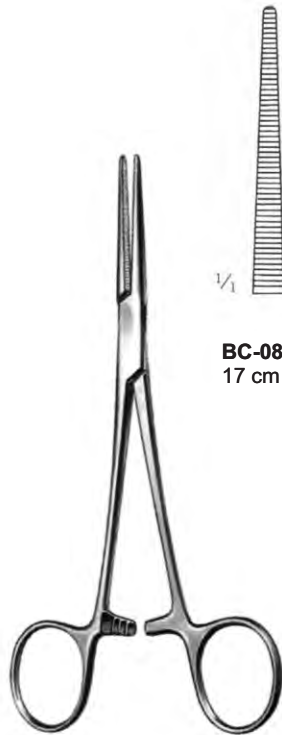

Crile-Rankin



BC-08-101
 17 cm / 6³/₄"



BC-08-102
 17 cm / 6³/₄"



Lovelace



BC-08-103
 17 cm / 6³/₄"



BC-08-104
 17 cm / 6³/₄"

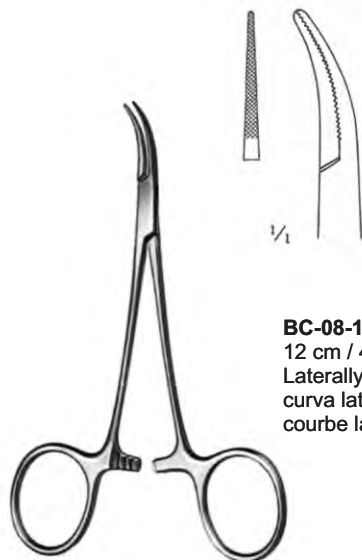
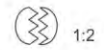

Dandy-Mosquito

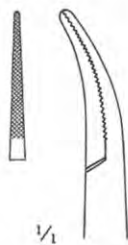

BC-08-105
 12 cm / 4³/₄"
 Laterally curved
 curva lateralmente
 courbe lateralment



Dandy



BC-08-106
 14.5 cm / 5³/₄"
 Laterally curved
 Curva lateralmente
 courbe lateralment

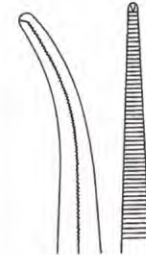

BC-08-107
 14.5 cm / 5³/₄"
 Laterally curved
 Curva lateralmente
 courbe lateralment





Halsted-Mosquito

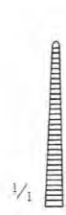

BC-08-108
12.5 cm / 5"



BC-08-109
14.5 cm / 5 3/4"



BC-08-110
12 cm / 4 3/4"



BC-08-111
14 cm / 5 1/2"



BC-08-112
12.5 cm / 5"

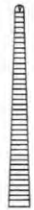

BC-08-113
14.5 cm / 5 3/4"



BC-08-114
12 cm / 4 3/4"



BC-08-115
14 cm / 5 1/2"



Halsted-Mosquito



BC-08-116
12.5 cm / 5"



BC-08-117
12 cm / 4 3/4"



BC-08-118
12 cm / 4 3/4"



BC-08-119
12 cm / 4 3/4"





Halsted-Mosquito

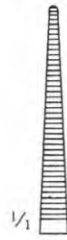

BC-08-120
 18.5 cm / 7 1/4"



BC-08-121
 18 cm / 7"

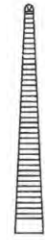

BC-08-122
 18.5 cm / 7 1/4"



BC-08-123
 18 cm / 7"



BC-08-124
 21 cm / 8 1/4"



BC-08-125
 20.5 cm / 8"

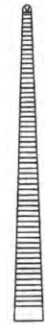

BC-08-126
 21 cm / 8 1/4"



BC-08-127
 20.5 cm / 8 1/4"



Mikro-Mosquito

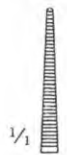

BC-08-128
 10 cm / 4"



BC-08-129
 12 cm / 4 3/4"



BC-08-130
 9.5 cm / 3 3/4"



BC-08-131
 11.5 cm / 4 1/2"

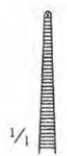

BC-08-132
 10 cm / 4"



BC-08-133
 12 cm / 4 3/4"



BC-08-134
 10 cm / 4"



BC-08-135
 12 cm / 4 3/4"





Kelly

BC-08-500 16 cm / 6 ¼"
BC-08-501 18 cm / 7"
BC-08-502 20 cm / 8"
BC-08-503 23 cm / 9"
BC-08-504 25 cm / 10"



BC-08-510 16 cm / 6 ¼"
BC-08-511 18 cm / 7"
BC-08-512 20 cm / 8"
BC-08-513 23 cm / 9"
BC-08-514 25 cm / 10"

BC-08-520 16 cm / 6 ¼"
BC-08-521 18 cm / 7"
BC-08-522 20 cm / 8"
BC-08-523 23 cm / 9"
BC-08-524 25 cm / 10"

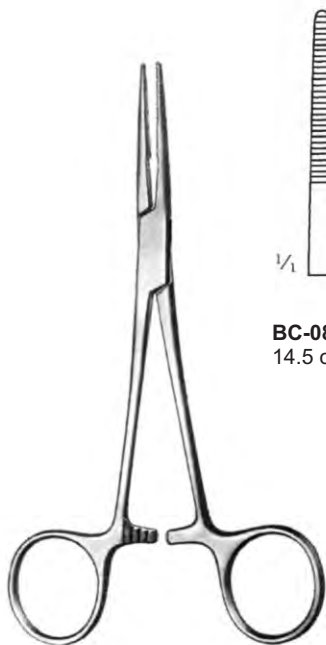

Kelly

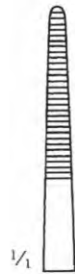

BC-08-136
14.5 cm / 5¾"



BC-08-137
14 cm / 5½"



Crile



BC-08-138
14.5 cm / 5¾"



BC-08-139
14 cm / 5½"



½ Kelly-Rankin



BC-08-140
 16 cm / 6¼"



BC-08-141
 15.5 cm / 6"

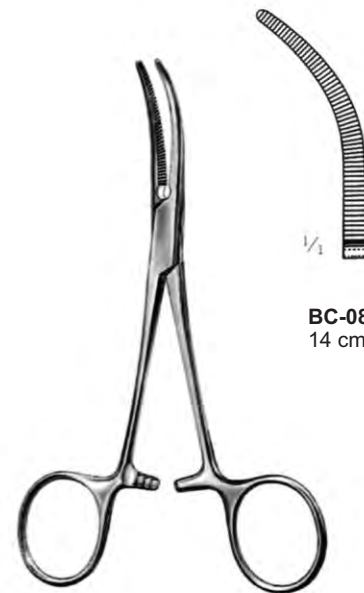

½ Overholt-Baby



BC-08-142
 14 cm / 5½"



½ Crile

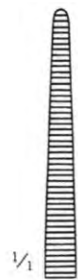

BC-08-143
 14.5 cm / 5¾"



BC-08-144
 14 cm / 5½"



BC-08-145
 20.5 cm / 8"



BC-08-146
 20.5 cm / 8"



1:2



1:2

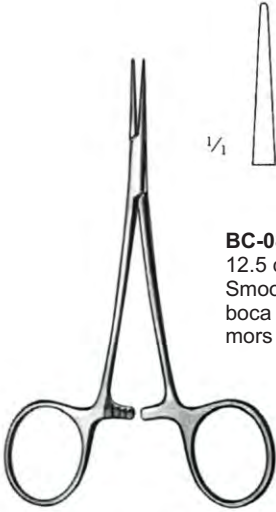

BC-08-148
12.5 cm / 5"
Smooth jaw
boca lisa
mors lisse

Ligature forceps
Pinza para hilos
Pince a ligatures



Mixer-Baby



BC-08-149
13.5 cm / 5 1/4"



BC-08-150
13 cm / 5"

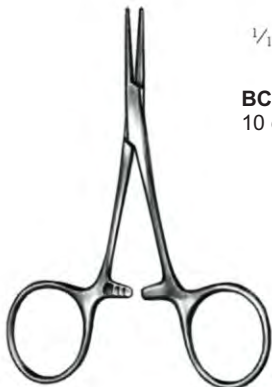

BC-08-151
10 cm / 4"

Hartmann



BC-08-152
9.5 cm / 3 3/4"



BC-08-153
12.5 cm / 5"
Cross serrated jaw
boca estriada en forma de cruz
mors a rainures croisees

Ligature forceps
Pinza para hilos
Pince a ligatures



BC-08-154
 14 cm / 5 1/2"



BC-08-155
 14 cm / 5 1/2"

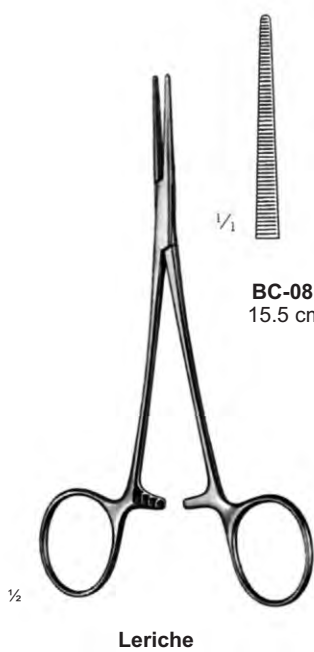

BC-08-156
 15.5 cm / 6"



BC-08-157
 15 cm / 6"

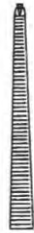

BC-08-158
 15.5 cm / 6"



BC-08-159
 15 cm / 6"

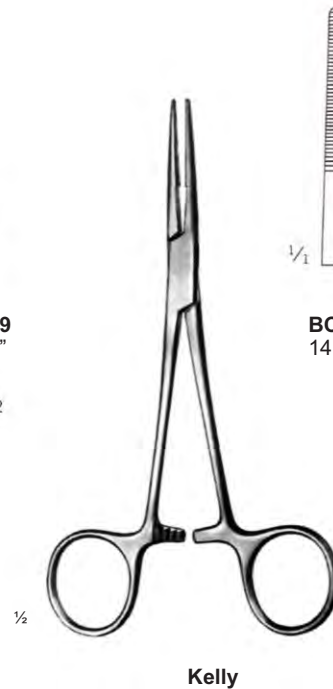

BC-08-160
 14.5 cm / 5 3/4"



BC-08-161
 14 cm / 5 1/2"



½

Pean



½

BC-08-162
14.5 cm / 5¾"



BC-08-163
16 cm / 6¼"

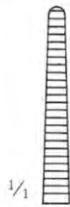

½

BC-08-164
13 cm / 5"



BC-08-165
14 cm / 5½"

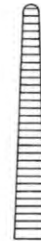

BC-08-166
15.5 cm / 6"



BC-08-167
18.5 cm / 7¼"

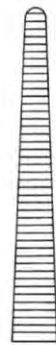

BC-08-168
20 cm / 8"



½

Spencer-Wells



½

BC-08-169
13 cm / 5"



BC-08-170
14 cm / 5½"



BC-08-171
15 cm / 6"



BC-08-172
18 cm / 7"



BC-08-173
20 cm / 8"

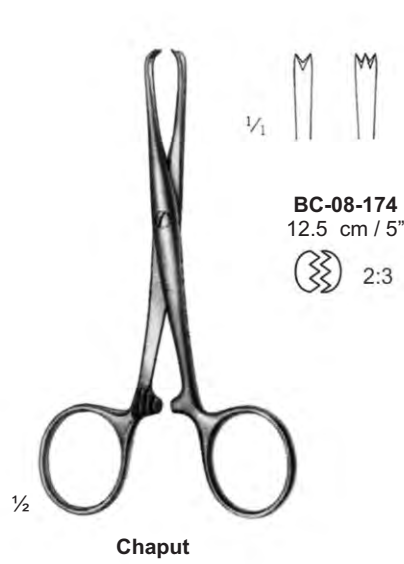

Organ-Grasping

Atrauma





BC-08-178
14 cm / 5½"

Collin



BC-08-179
17 cm / 6¾"

Collin

Tumor grasping forceps
Pinzas para sacar organ
Pinces a tumeurs avis

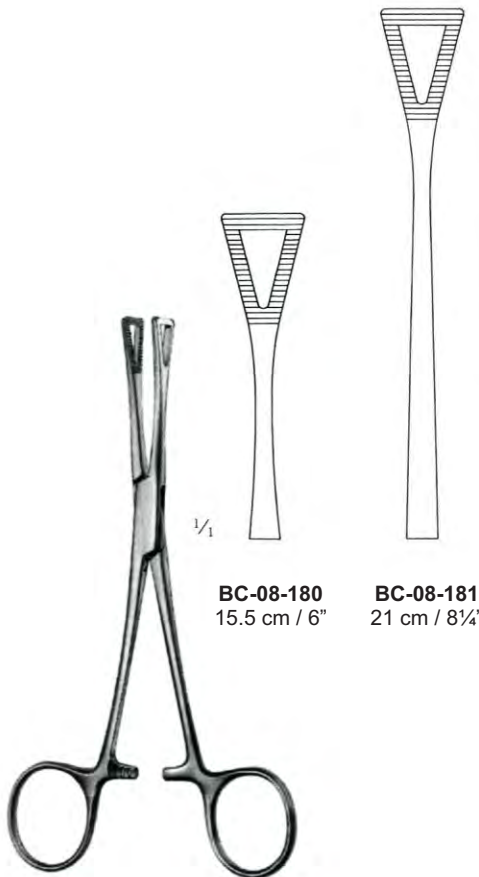

BC-08-180
15.5 cm / 6"

BC-08-181
21 cm / 8¼"

Pennington



BC-08-182
15 cm / 6"

Pratt



BC-08-183
13.5 cm / 5¼"

Martel-Rees

Face lift forceps
Pinza para Face-Lift
Pinces pour Face-lift



Schnidt

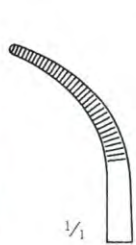

BC-08-184
 18,5 cm / 7¼"



BC-08-185
 19 cm / 7½"



Adson



BC-08-186
 19 cm / 7½"



BC-08-187
 18.5 cm / 7¼"

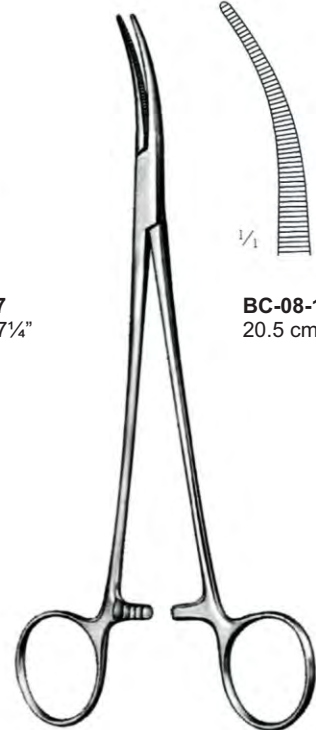

Martin-Fuchsig



BC-08-188
 20.5 cm / 8"



Rochester-Carmalt



BC-08-189
 17 cm / 6¾"



BC-08-190
 20.5 cm / 8"



BC-08-191
 16.5 cm / 6½"



BC-08-192
 20 cm / 8"



Pean

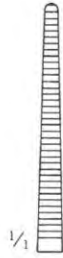

BC-08-193
13.5 cm / 5¼"



BC-08-194
14.5 cm / 5¾"



BC-08-195
17 cm / 6¾"



BC-08-196
13 cm / 5"



BC-08-197
14 cm / 5½"

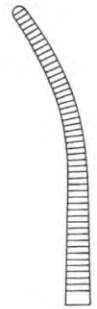

BC-08-198
16.5 cm / 6½"



Kocher

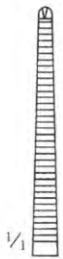

BC-08-199
13 cm / 5"

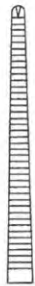

BC-08-200
14 cm / 5½"



BC-08-201
16 cm / 6¼"



BC-08-202
13 cm / 5"







BC-08-203
14 cm / 5½"



BC-08-204
16 cm / 6¼"



Pean-Nippon

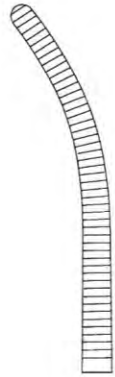





					
$\frac{1}{2}$					
BC-08-205 14.5 cm / 5¾"	BC-08-206 16.5 cm / 6½"	BC-08-207 18.5 cm / 7¼"	BC-08-208 14 cm / 5½"	BC-08-209 16 cm / 6¼"	BC-08-210 18 cm / 7"

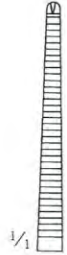

$\frac{1}{2}$

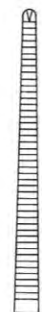
Kocher-Nippon



					
$\frac{1}{2}$					
BC-08-211 14.5 cm / 5¾"	BC-08-212 16.5 cm / 6½"	BC-08-213 18.5 cm / 7¼"	BC-08-214 14.5 cm / 5½"	BC-08-215 16 cm / 6¼"	BC-08-216 18 cm / 7"



BC-08-217
21.5 cm / 8½"



BC-08-218
21 cm / 8¼"



BC-08-219
21.5 cm / 8½"



BC-08-220
21 cm / 8¼"



Bengolea

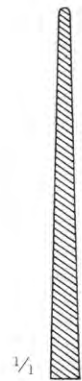

BC-08-221
26 cm / 10¼"



BC-08-222
25.5 cm / 10"



BC-08-223
26 cm / 10¼"



BC-08-224
25.5 cm / 10"

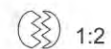

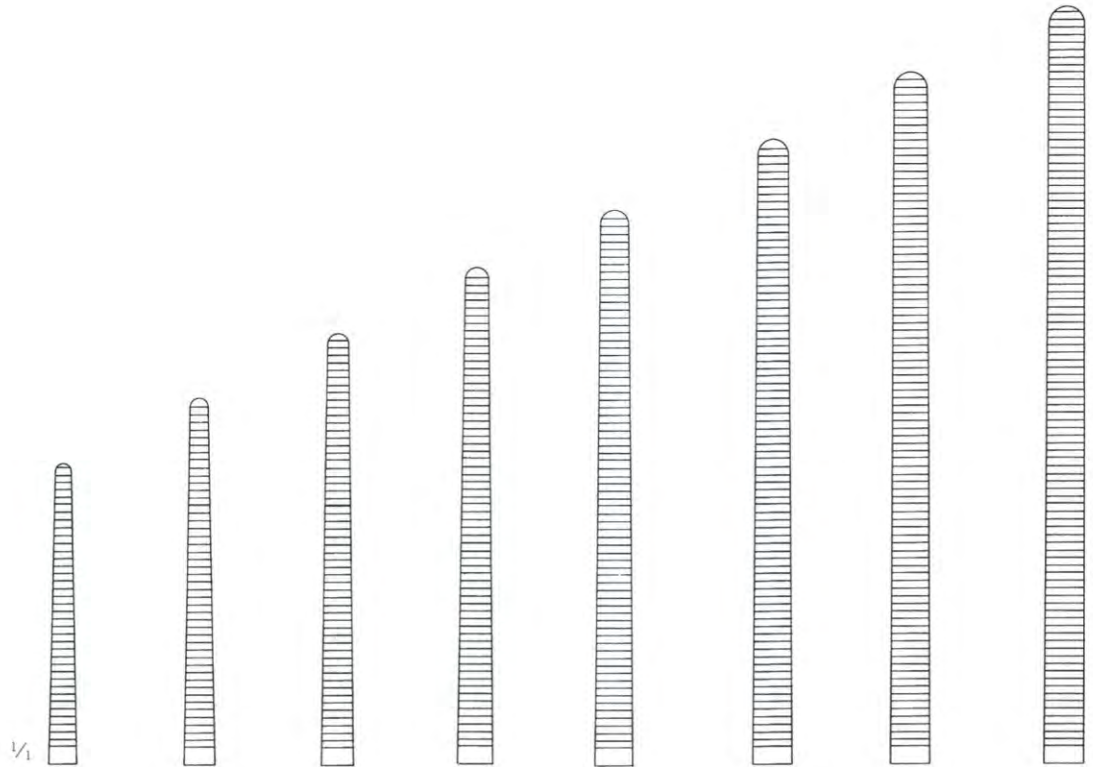

BC-08-225	BC-08-226	BC-08-227	BC-08-228	BC-08-229	BC-08-230	BC-08-231	BC-08-232
14.5 cm / 5 $\frac{3}{4}$ "	16.5 cm / 6 $\frac{1}{2}$ "	18.5 cm / 7 $\frac{1}{4}$ "	20.5 cm / 8"	22.5 cm / 8 $\frac{3}{4}$ "	24.5 cm / 9 $\frac{3}{4}$ "	26 cm / 10 $\frac{1}{4}$ "	30.5 cm / 12"



Pean (Rochester)

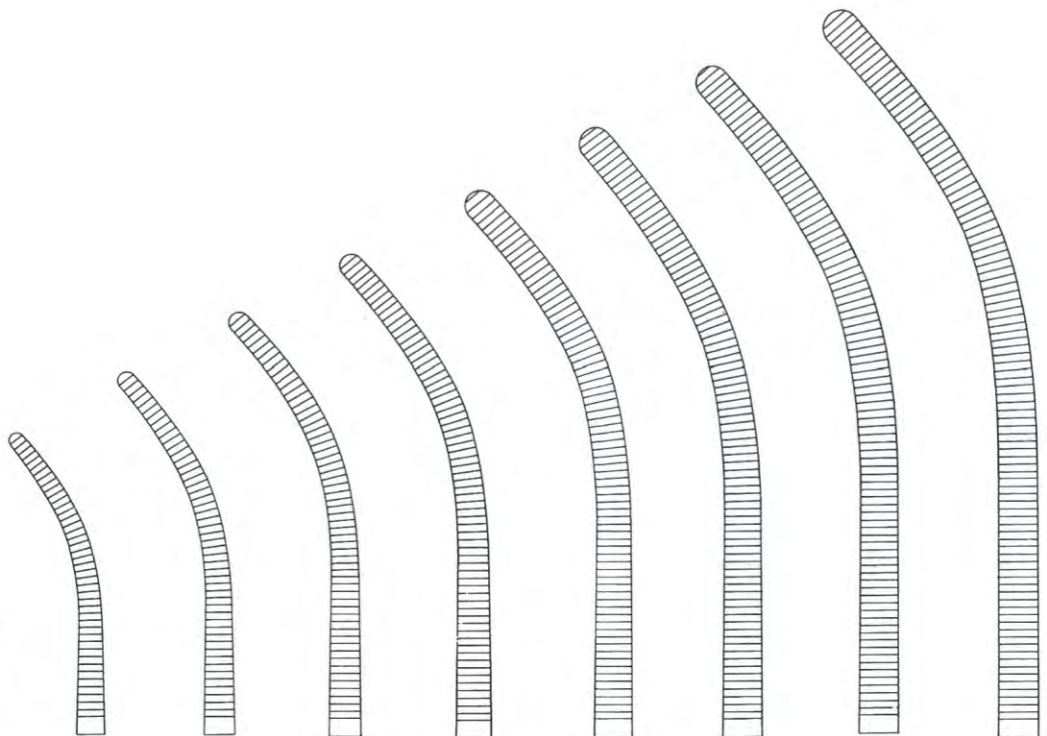

BC-08-233	BC-08-234	BC-08-235	BC-08-236	BC-08-237	BC-08-238	BC-08-239	BC-08-240
14 cm / 5 $\frac{1}{2}$ "	16 cm / 6 $\frac{1}{4}$ "	18 cm / 7"	20 cm / 8"	22 cm / 8 $\frac{3}{4}$ "	24 cm / 9 $\frac{1}{2}$ "	25.5 cm / 10"	30 cm / 11 $\frac{1}{4}$ "

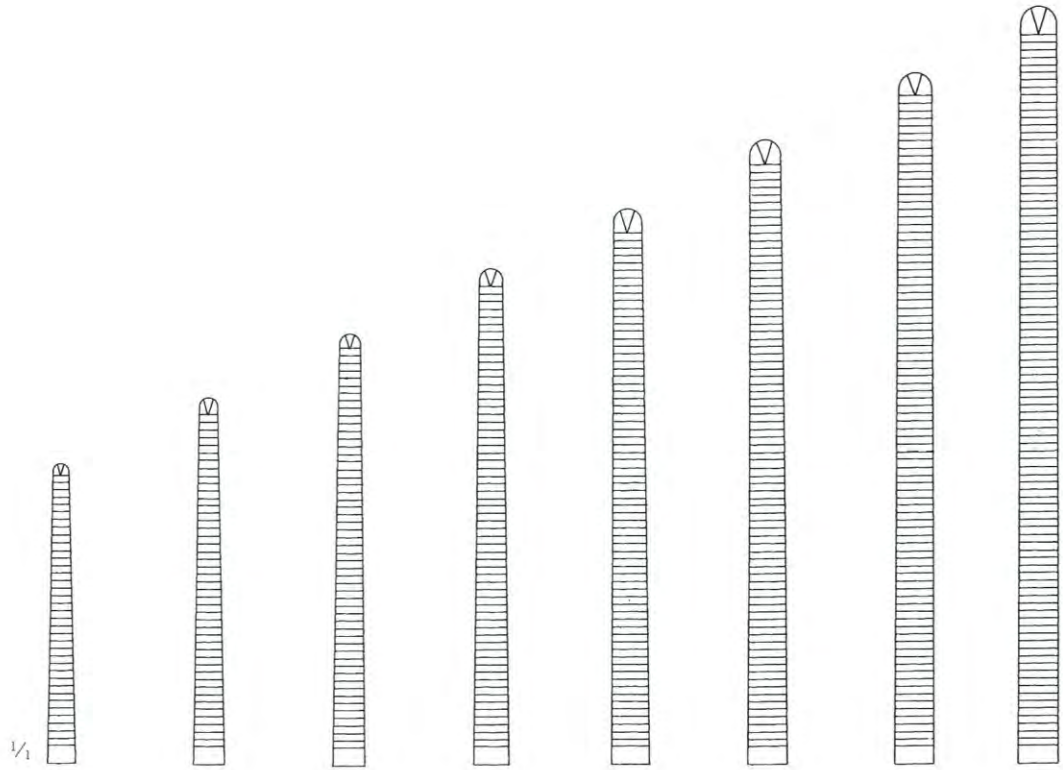

BC-08-241 14.5 cm / 5¾"	BC-08-242 16.5 cm / 6½"	BC-08-243 18.5 cm / 7¼"	BC-08-244 20.5 cm / 8"	BC-08-245 22.5 cm / 8¾"	BC-08-246 24.5 cm / 9¾"	BC-08-247 26 cm / 10¼"	BC-08-248 30.5 cm / 12"
-----------------------------------	-----------------------------------	-----------------------------------	----------------------------------	-----------------------------------	-----------------------------------	----------------------------------	-----------------------------------



Kocher (Ochsner)

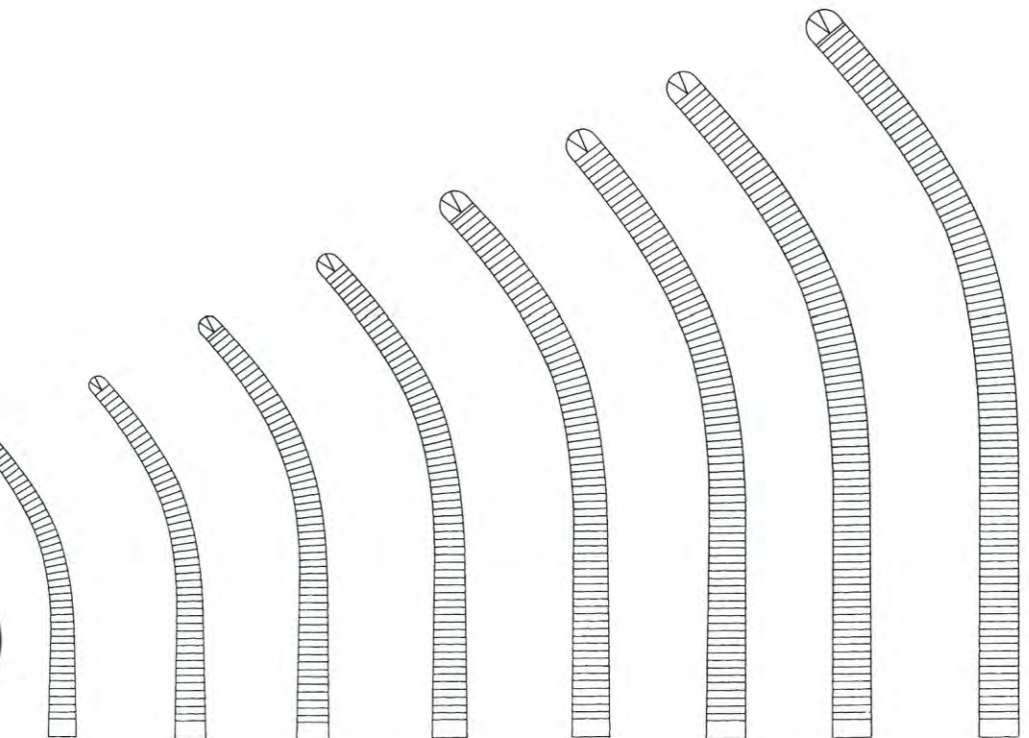
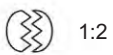

BC-08-249 14 cm / 5½"	BC-08-250 16 cm / 6¼"	BC-08-251 18 cm / 7"	BC-08-252 20 cm / 8"	BC-08-253 22 cm / 8¾"	BC-08-254 24 cm / 9½"	BC-08-255 25.5 cm / 10"	BC-08-256 30 cm / 11¾"
---------------------------------	---------------------------------	--------------------------------	--------------------------------	---------------------------------	---------------------------------	-----------------------------------	----------------------------------



Overholt-Martin

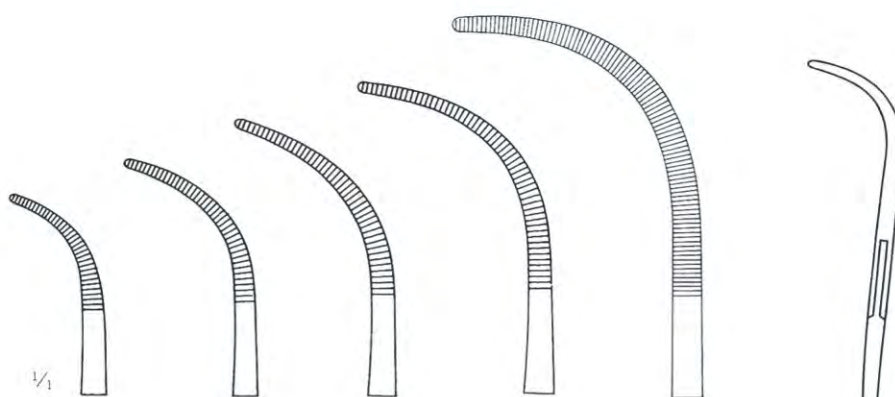

BC-08-257
18.5 cm / 7¼"
Fig. 1

BC-08-258
20.5 cm / 8"
Fig. 2

BC-08-259
21 cm / 8¼"
Fig. 3

BC-08-260
21.5 cm / 8½"
Fig. 4

BC-08-261
24.5 cm / 9¾"
Fig. 5



BC-08-262
18.5 cm / 7 $\frac{1}{4}$ "

Mixer-Baby



BC-08-263
14.5 cm / 5 $\frac{3}{4}$ "



BC-08-264
18 cm / 7"

Adson-Baby

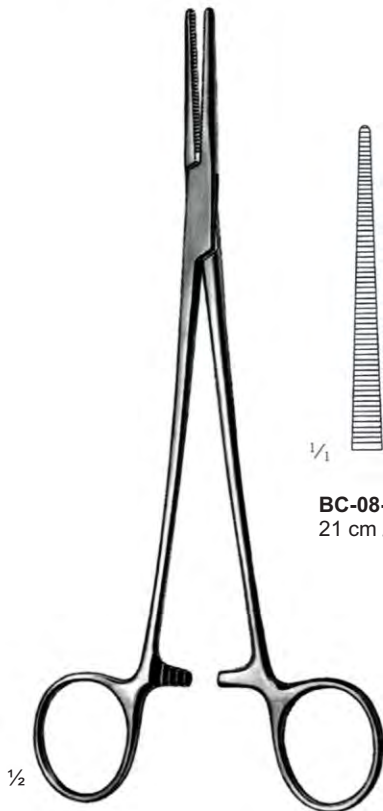

BC-08-265
21 cm / 8 $\frac{1}{4}$ "

Heiss



BC-08-266
20.5 cm / 8"



BC-08-267
20 cm / 8"



BC-08-268
21.5 cm / 8 $\frac{1}{2}$ "

Overholt-Mixer

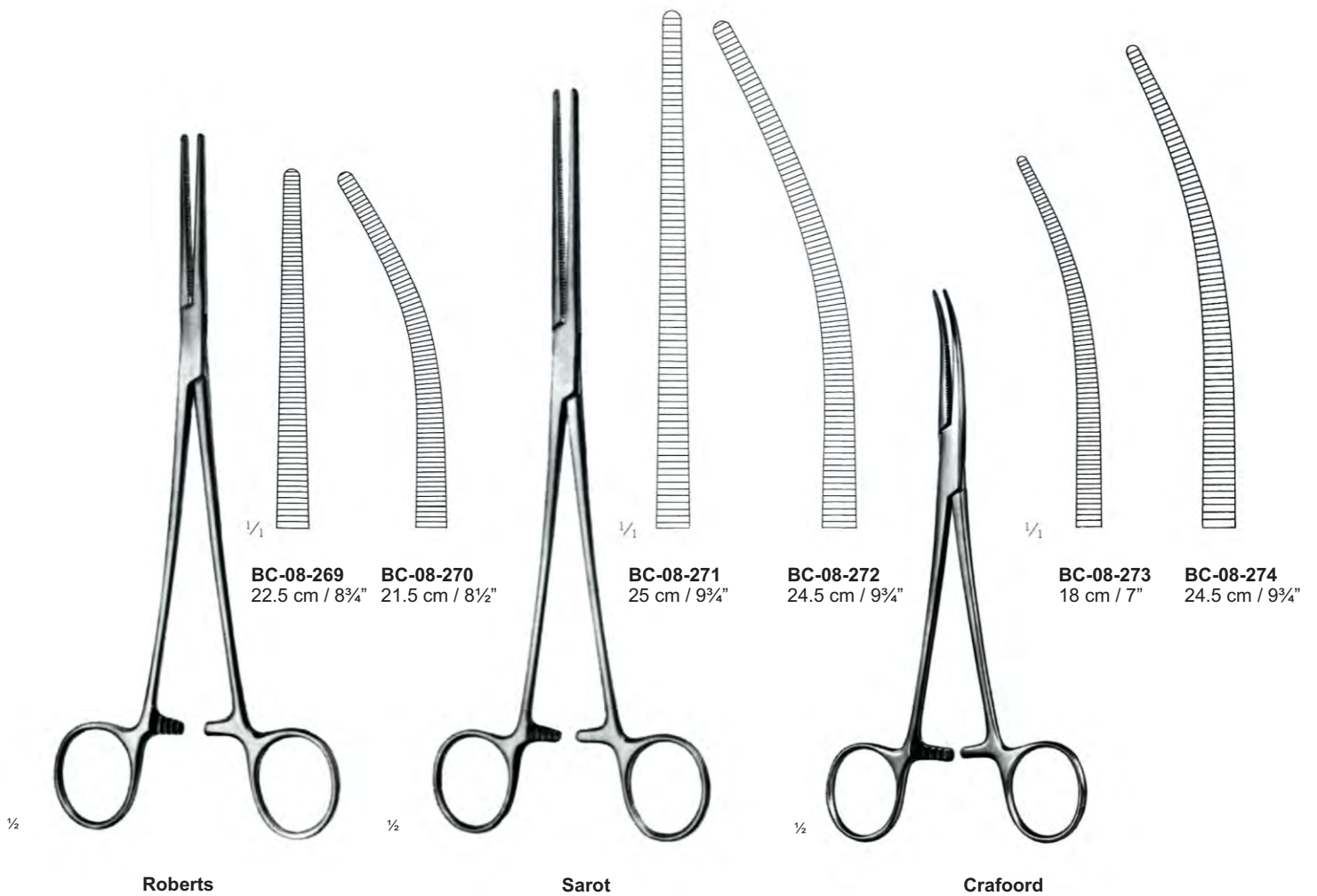

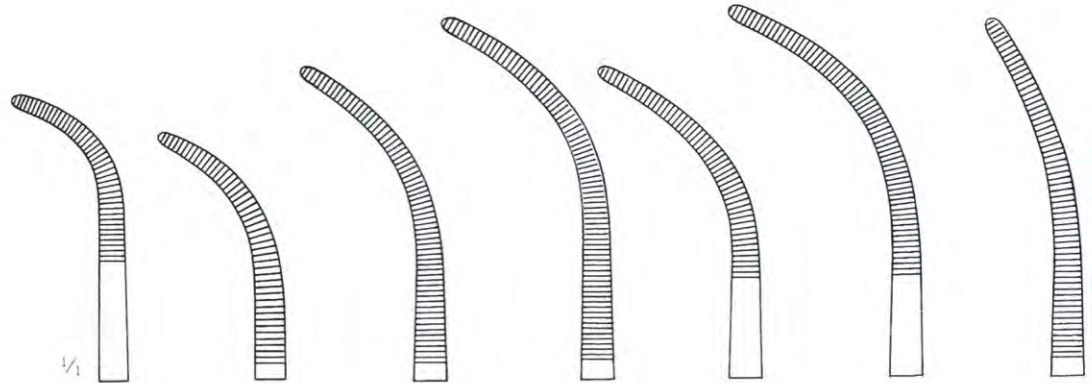

BC-08-275
20.5 cm / 8"
Fig. 1

BC-08-276
20 cm / 8"
Fig. 2

BC-08-277
21.5 cm / 8½"
Fig. 3

BC-08-278
22 cm / 8¾"
Fig. 4

BC-08-279
21.5 cm / 8½"
Fig. 5

BC-08-280
22 cm / 8¾"
Fig. 6

BC-08-281
22 cm / 8¾"
Fig. 7

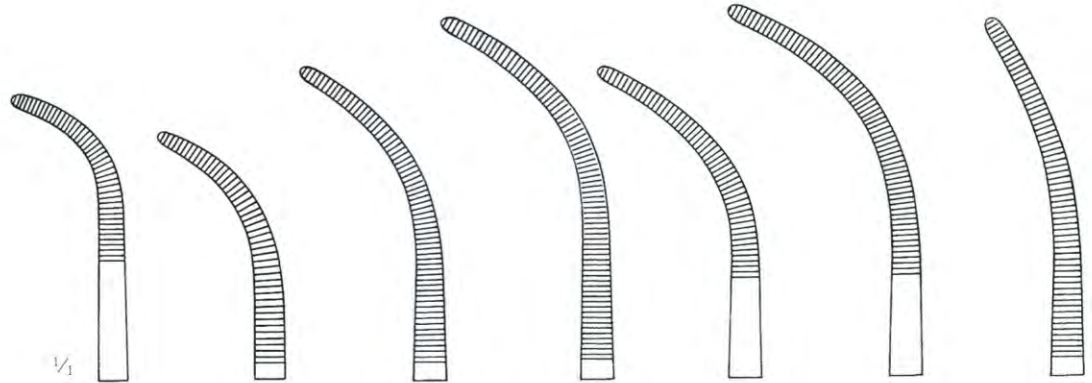

BC-08-282
27 cm / 10¾"
Fig. 1

BC-08-283
26.5 cm / 10½"
Fig. 2

BC-08-284
27.5 cm / 10¾"
Fig. 3

BC-08-285
28 cm / 11"
Fig. 4

BC-08-286
27.5 cm / 10¾"
Fig. 5

BC-08-287
28 cm / 11"
Fig. 6

BC-08-288
27.5 cm / 10¾"
Fig. 7



Overholt-Geissendorfer



Overholt-Fino

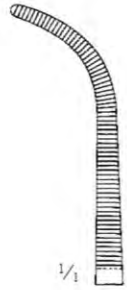

BC-08-289
 21.5 cm / 8½"



BC-08-290
 21 cm / 8½"



BC-08-291
 22 cm / 8½"



BC-08-292
 23 cm / 9"



BC-08-293
 22.5 cm / 8¾"



Rumel

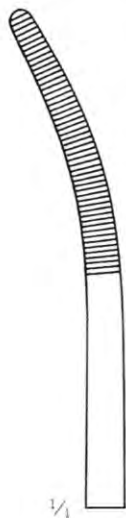

BC-08-294
 24 cm / 9½"

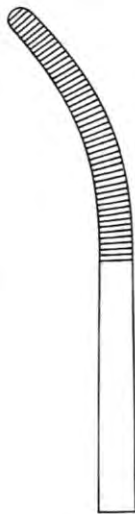

BC-08-295
 23.5 cm / 9¼"

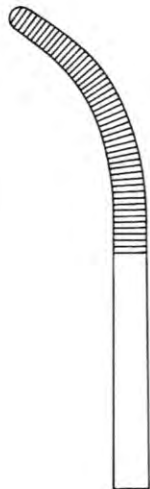

BC-08-296
 23 cm / 9"



BC-08-297
 24 cm / 9½"

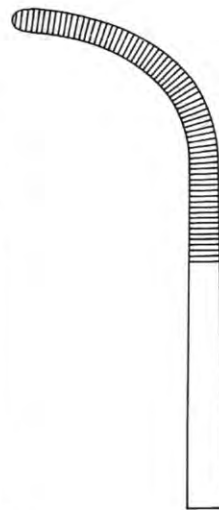

BC-08-298
 23.5 cm / 9¼"

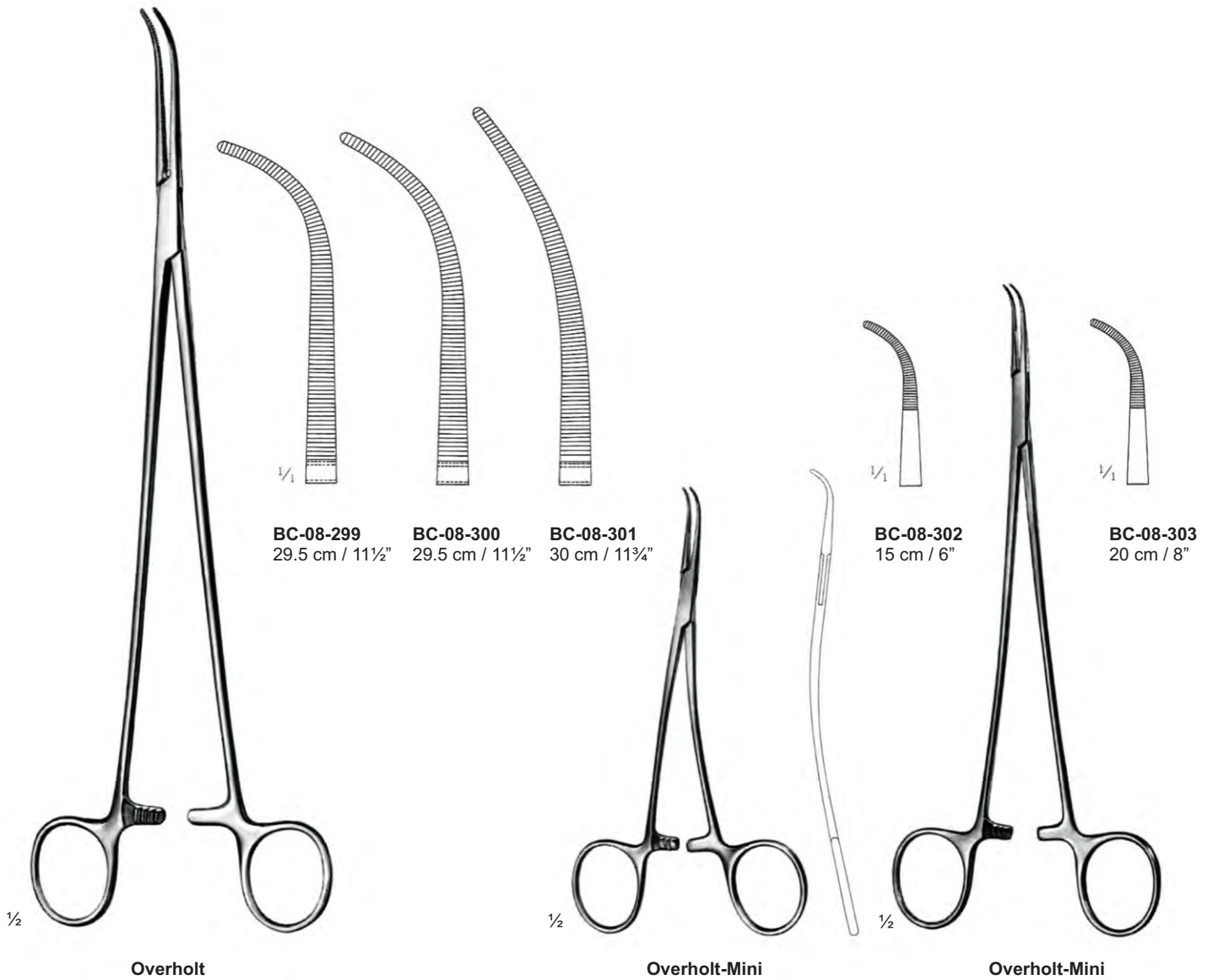



Mini-Gemini

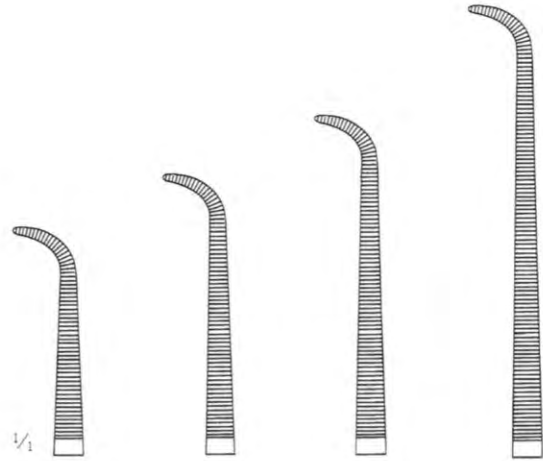

- BC-08-304** 18 cm / 7"
- BC-08-305** 22.5 cm / 8¾"
- BC-08-306** 25 cm / 9¾"
- BC-08-307** 28.5 cm / 11¼"



Gemini

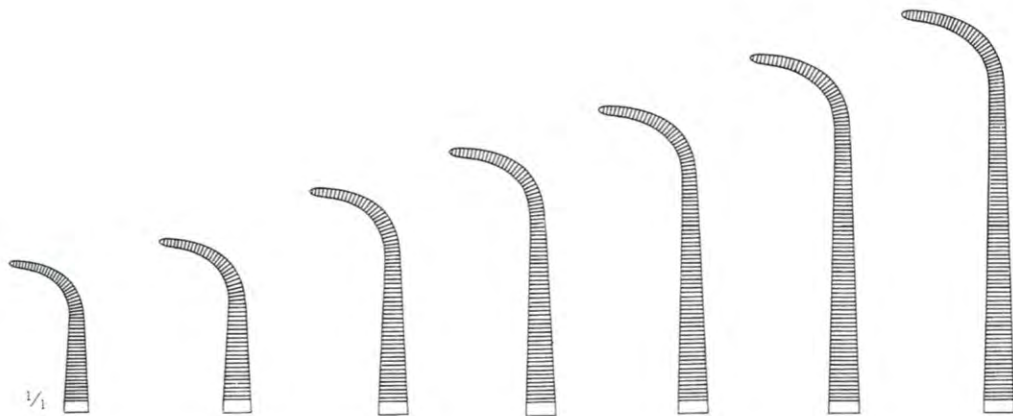

- BC-08-308** 13 cm / 5"
- BC-08-309** 16 cm / 6¼"
- BC-08-310** 18 cm / 7"
- BC-08-311** 21 cm / 8¼"
- BC-08-312** 23cm / 9"
- BC-08-313** 25 cm / 9¾"
- BC-08-314** 28 cm / 11"



Zenker



BC-08-315
29.5 cm / 11½"

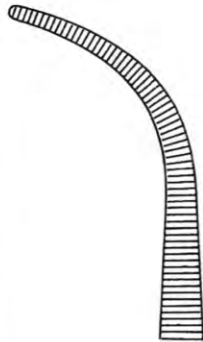

BC-08-316
28.5 cm / 11¼"



Mixer-Baby



BC-08-317
13.5 cm / 5¼"



BC-08-318
 16 cm / 6 1/4"

Mixer

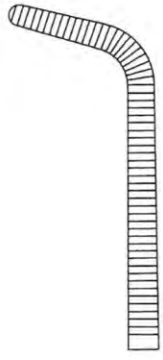

BC-08-319
 18 cm / 7"

Mixer-O'Shaughnessy



BC-08-320
 18 cm / 7"



BC-08-321
 22.5 cm / 8 3/4"

Mixer

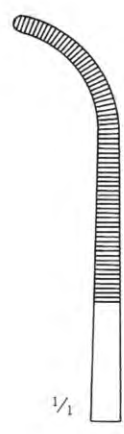

BC-08-322
 23 cm / 9"



Mixer



Wickström

1/1

BC-08-323
21 cm / 8 1/4"



BC-08-324
24.5 cm / 9 3/4"



Mixer

1/1

BC-08-325
22.5 cm / 8 3/4"

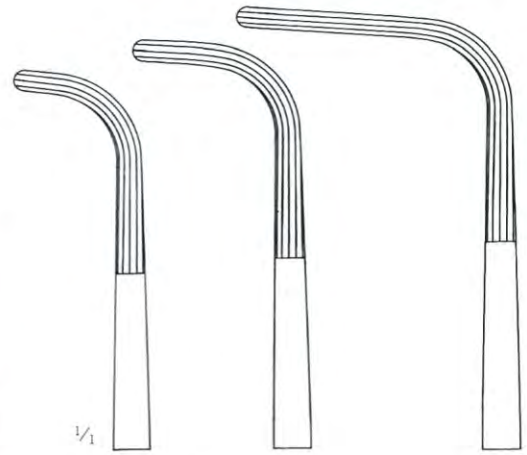

BC-08-326
26 cm / 10 1/4"

BC-08-327
28 cm / 11"



Mc Quigg-Mixer

BC-08-328
 23.5 cm / 9¼"



Lower

BC-08-329
 18.5 cm / 7¼"



Lahey

BC-08-330
 19.5 cm / 7¾"

BC-08-331
 22.5 cm / 8¾"

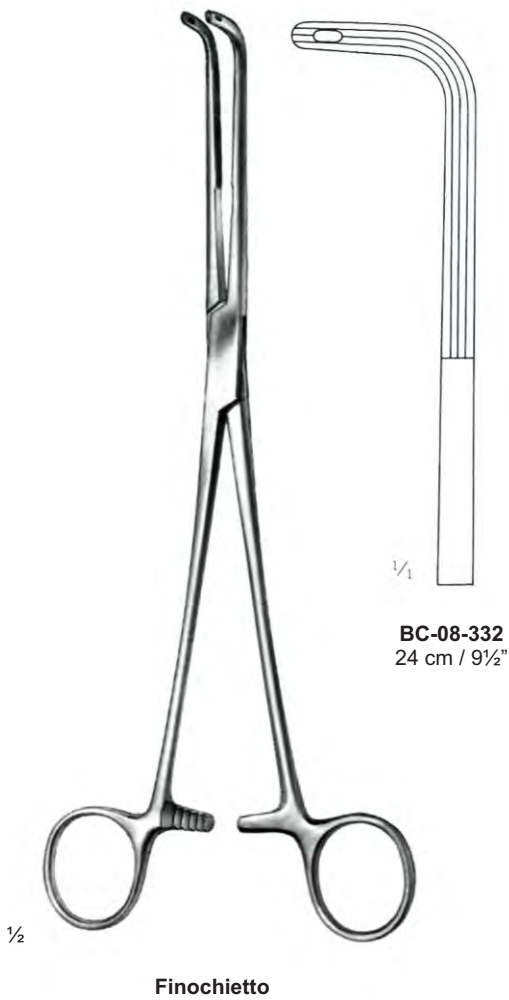

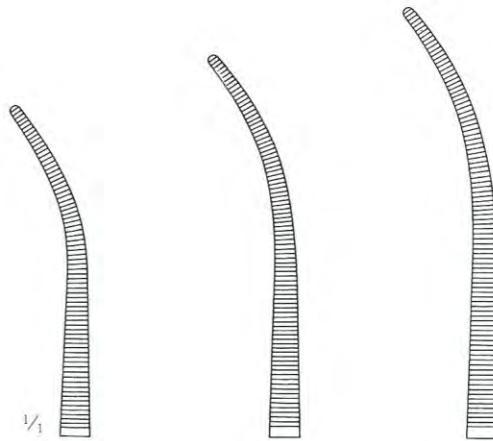

BC-08-335
 19.5 cm / 7³/₄"
 Fig. 1

BC-08-336
 22.5 cm / 8³/₄"
 Fig. 1

BC-08-337
 24.5 cm / 9³/₄"
 Fig. 1

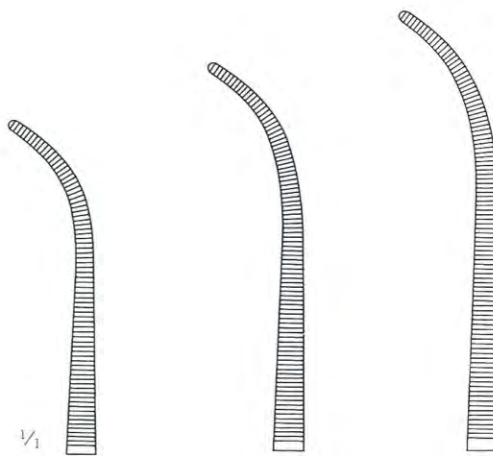

BC-08-338
 19 cm / 7¹/₂"
 Fig. 2

BC-08-339
 22 cm / 8³/₄"
 Fig. 2

BC-08-340
 24cm / 9¹/₂"
 Fig. 2

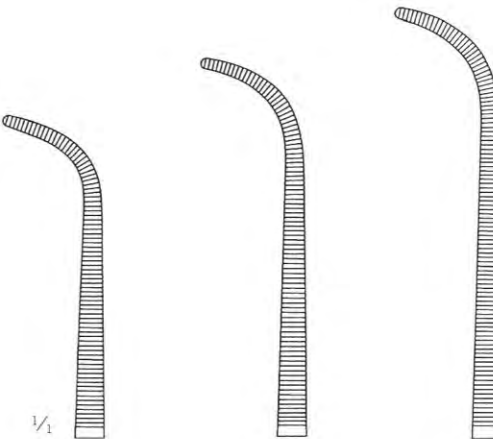

BC-08-341
 18.5 cm / 7¹/₄"
 Fig.3

BC-08-342
 21.5 cm / 8¹/₂"
 Fig. 3

BC-08-343
 23.5 cm / 9¹/₄"
 Fig. 3



Kelly



BC-08-344
23 cm / 9"

Guyon



BC-08-345
24 cm / 9½"

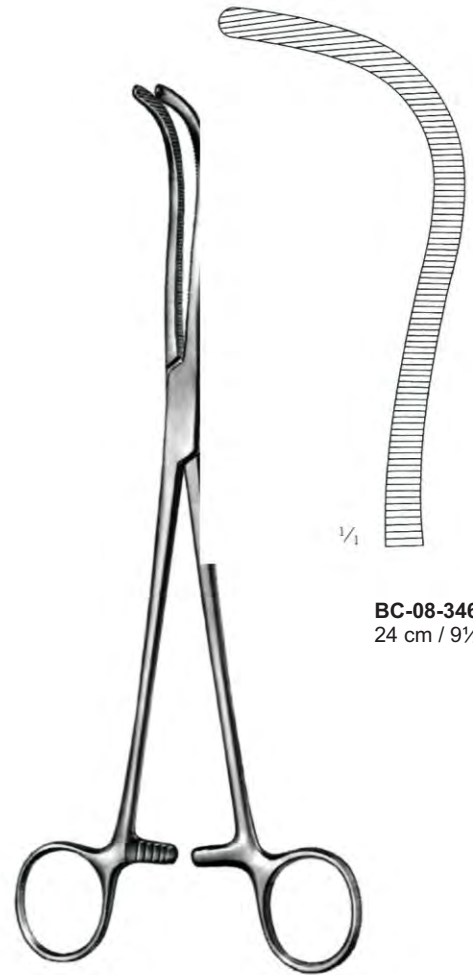

BC-08-346
24 cm / 9½"

Guyon



1/2

Guyon



1/4

BC-08-347
19.5 cm / 7 3/4"

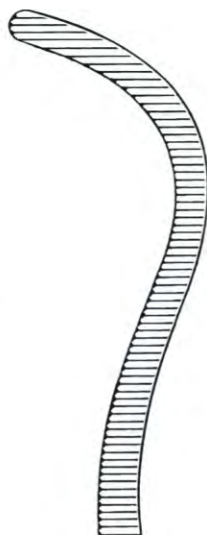

BC-08-348
21.5 cm / 8 1/2"

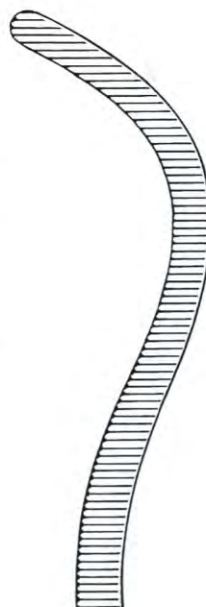

BC-08-349
24 cm / 9 1/2"



1/2

Desjardins

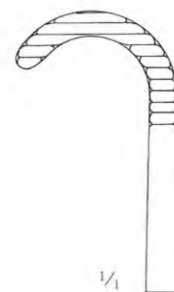

1/4

BC-08-350
21 cm / 8 1/4"





Wertheim-Cullen

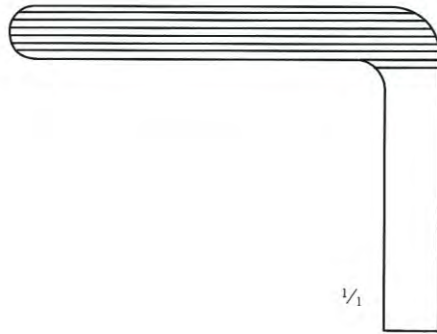

BC-08-353
21 cm / 8 1/4"



Negus



BC-08-354
19.5 cm / 7 3/4"
Fig. 1



BC-08-355
20 cm / 8"
Fig. 2



Phaneuf



BC-08-356
20.5 cm / 8"



1:2

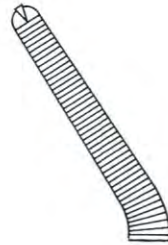

BC-08-357
20 cm / 8"



1:2



BC-08-358
19.5 cm / 7¾"
Fig. 1



BC-08-359
21.5 cm / 8½"
Fig. 1



BC-08-360
24 cm / 9½"
Fig. 1



Heaney



BC-08-361
19.5 cm / 7¾"
Fig. 2



BC-08-362
21.5 cm / 8¼"
Fig. 2



BC-08-363
24 cm / 9½"
Fig. 2



Rogers

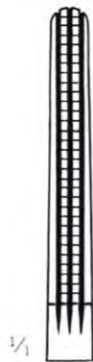

1/4

BC-08-364
 21.5 cm / 8½"
 Fig. 1



BC-08-365
 21 cm / 8¼"
 Fig. 2



BC-08-366
 20.5 cm / 8"
 Fig. 3

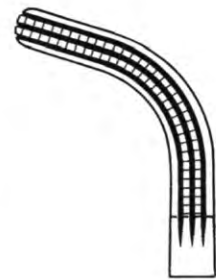

BC-08-367
 20 cm / 8"
 Fig. 4

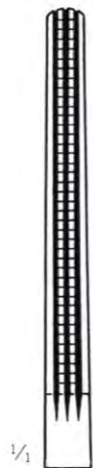

1/4

BC-08-368
 25.5 cm / 10"
 Fig. 1



BC-08-369
 25 cm / 9¾"
 Fig. 2



BC-08-370
 24.5 cm / 9¾"
 Fig. 3



Wertheim



BC-08-371
22.5 cm / 8¾"



Slightly curved
curva ligera
courbe legere



BC-08-372
22.5 cm / 8¾"



More curved
curve fuerte
courbe forte



Mikulicz, Baby



BC-08-373
14.5 cm / 5¾"



Mikulicz



BC-08-374
18.5 cm / 7¼"



Mikulicz



BC-08-375
20 cm / 8"

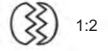



BC-08-376
23 cm / 9"

Moynihan



BC-08-377
23.5 cm / 9¼"

Moynihan



BC-08-378
26 cm / 10¼"

Wertheim





Schädel
BC-08-383
 9 cm / 3½"
 sharp
 aguda
 aigue



BC-08-384
 5.5 cm / 2¼"

BC-08-385
 8.5 cm / 3¼"

Jones
 sharp
 aguda
 aigue



Jones-Martin
BC-08-386
 8.5 cm / 3¼"
 sharp
 aguda
 aigue

With tube holder
 con porta-tubo
 avec clamp porte-tube



¼

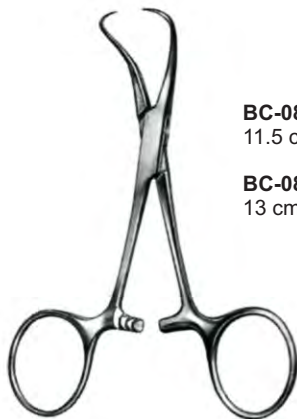

BC-08-387
 11.5 cm / 4½"

BC-08-388
 13 cm / 5"

Backhaus
 Delicate model
 modelo delicado
 modele gracile



With tube holder
 con porta-tubo
 avec clamp porte-tube

Backhaus
BC-08-389
 11.5 cm / 4½"



BC-08-390
 9 cm / 3½"

BC-08-391
 5.5 cm / 2¼"

BC-08-392
 13 cm / 5"

BC-08-393
 16 cm / 6¼"

Backhaus

½

½

½

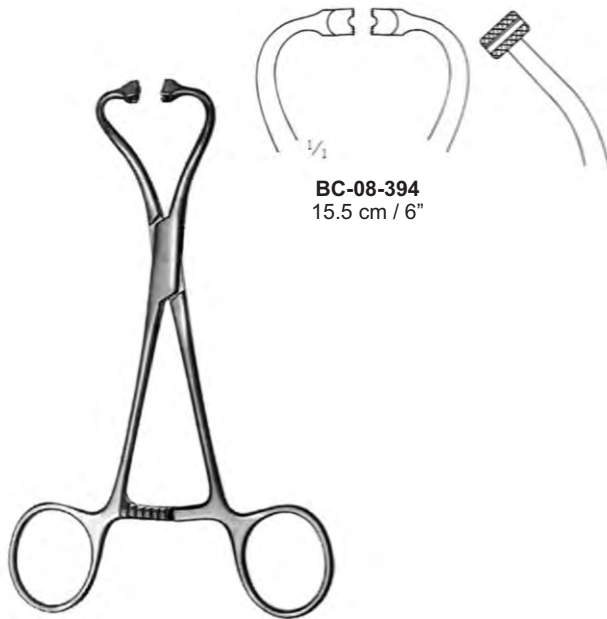

BC-08-394
15.5 cm / 6"

½ **Peers-Bertram modif.**
Wide jaw for tube fixation
boca ancha para fijacion de tubos
more large pour fixation de tube



½ **Röder**
BC-08-395
13.5 cm / 5¼"

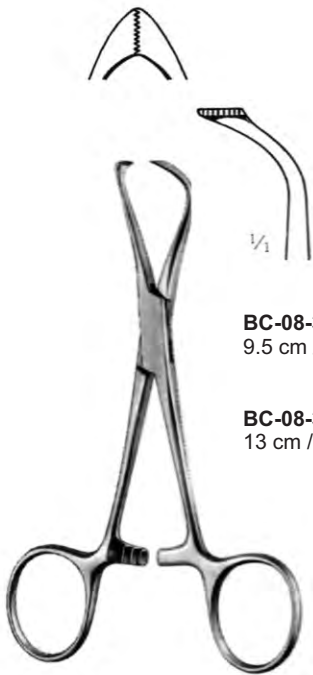

BC-08-396
9.5 cm / 3¾"

BC-08-397
13 cm / 5"

½ **Bernhard**
BC-08-398
16.5 cm / 6½"

Fine serrated wide jaw
boca ancha, delicadamente dentada
mors large avec dents fins



½ **Bernhard**
BC-08-398
16.5 cm / 6½"

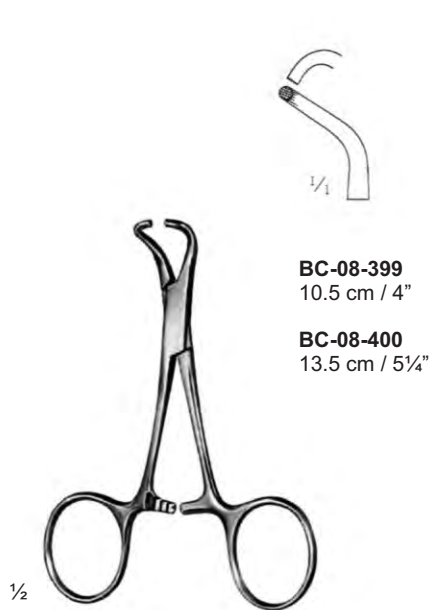

BC-08-399
 10.5 cm / 4"

BC-08-400
 13.5 cm / 5 1/4"

1/2

Tohoku
 Blunt
 roma
 moussee

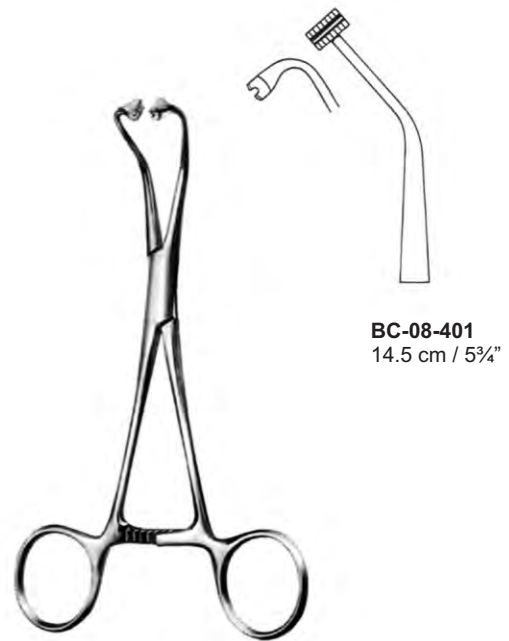

BC-08-401
 14.5 cm / 5 3/4"

Peers-Bertram

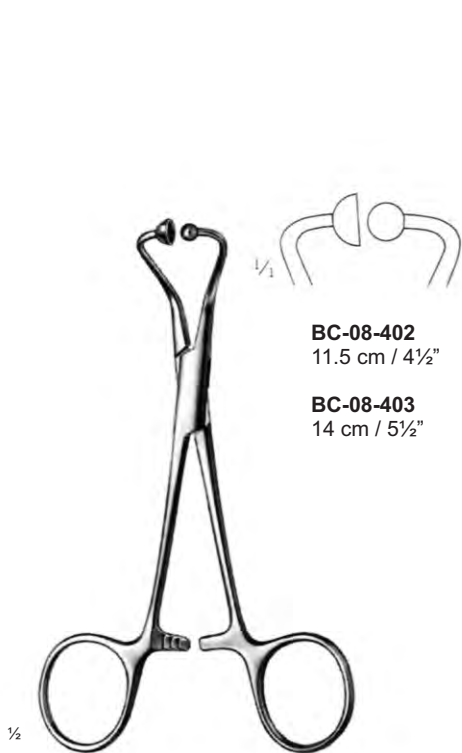

BC-08-402
 11.5 cm / 4 1/2"

BC-08-403
 14 cm / 5 1/2"

1/2

For paper clothes
 para panos de papel
 pour couverture en papier



BC-08-404
 19.5 cm / 7 3/4"

1/2

Lane

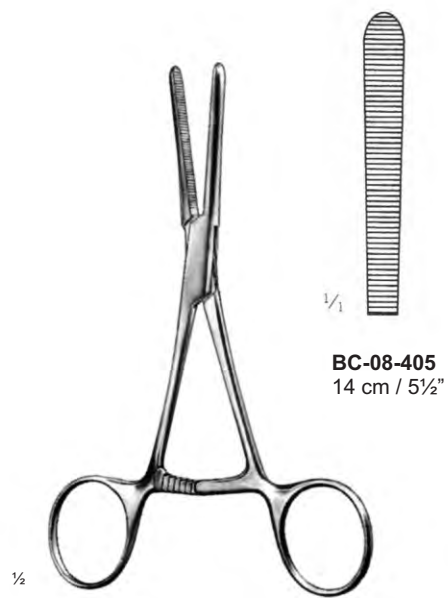

BC-08-405
14 cm / 5½"

Extra long ratchet
cremallera extra larga
cremaillere extremement longue

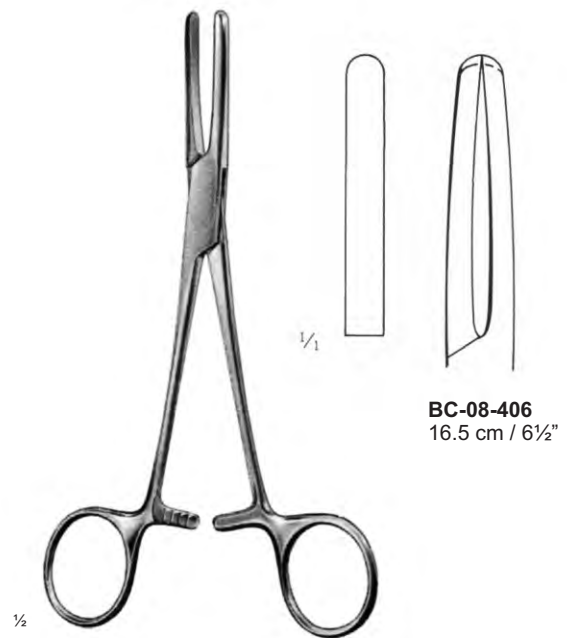

BC-08-406
16.5 cm / 6½"



1/2



BC-08-407
 15.5 cm / 6"



BC-08-408
 19 cm / 7 1/2"



BC-08-409
 20.5 cm / 8"



1/2



BC-08-410
 15.5 cm / 6"



BC-08-411
 19 cm / 7 1/2"



BC-08-412
 20.5 cm / 8"

With Safety guard
 con estribo de proteccion
 avec protection

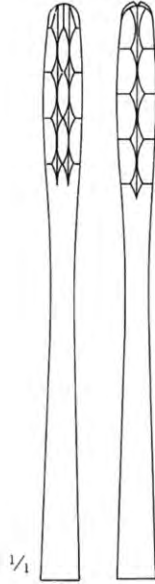

BC-08-413
22.5 cm / 8¾"

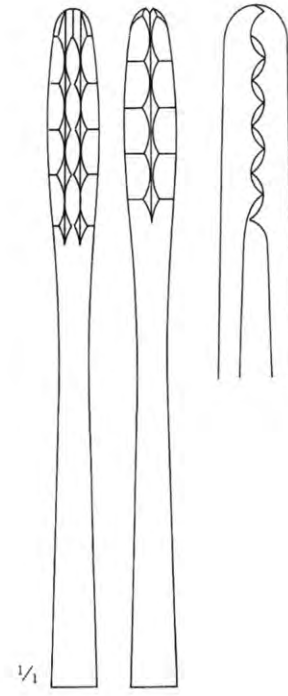

BC-08-414
26.5 cm / 10½"



½

Ulrich



½

BC-08-415
22.5 cm / 8¾"

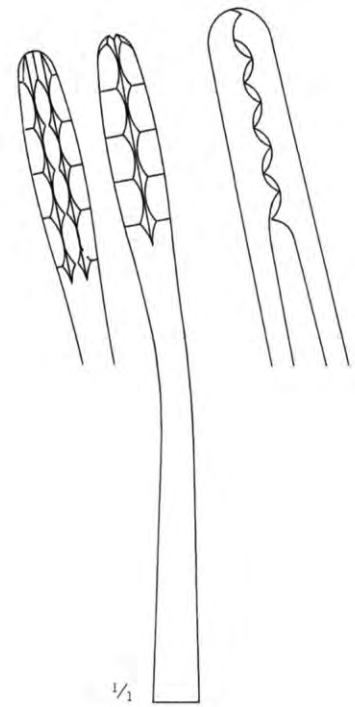

½

BC-08-416
26.5 cm / 10½"



1/2

Lister



1/4

BC-08-417
13 cm / 5"



BC-08-418
16 cm / 6 1/4"



BC-08-419
18 cm / 7"



1/2

Martin



1/4

BC-08-420
17.5 cm / 7"



BC-08-421
17 cm / 6 3/4"



Gross-Maier

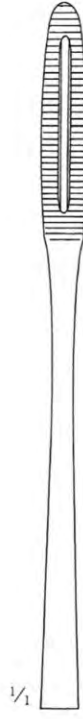

BC-08-422
20.5 cm / 8"

BC-08-424
22 cm / 8 $\frac{3}{4}$ "

BC-08-426
26.5 cm / 10 $\frac{1}{2}$ "



BC-08-423
20 cm / 8"

BC-08-425
21.5 cm / 8 $\frac{1}{2}$ "

BC-08-427
25 cm / 10 $\frac{1}{4}$ "





Foerster

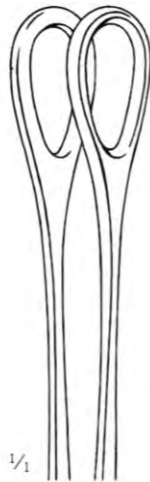

BC-08-431
25 cm / 9 3/4"
Smooth jaw
boca lisa
mors lisse



BC-08-432
18 cm / 7"

BC-08-433
20.5 cm / 8"

BC-08-434
25 cm / 9 3/4"



BC-08-435
24.5 cm / 9 3/4"
Smooth jaw
boca lisa
mors lisse

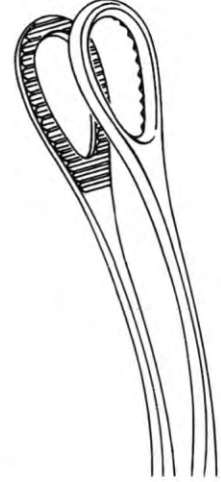

BC-08-436
17.5 cm / 7"

BC-08-437
20 cm / 8"

BC-08-438
24.5 cm / 9 3/4"

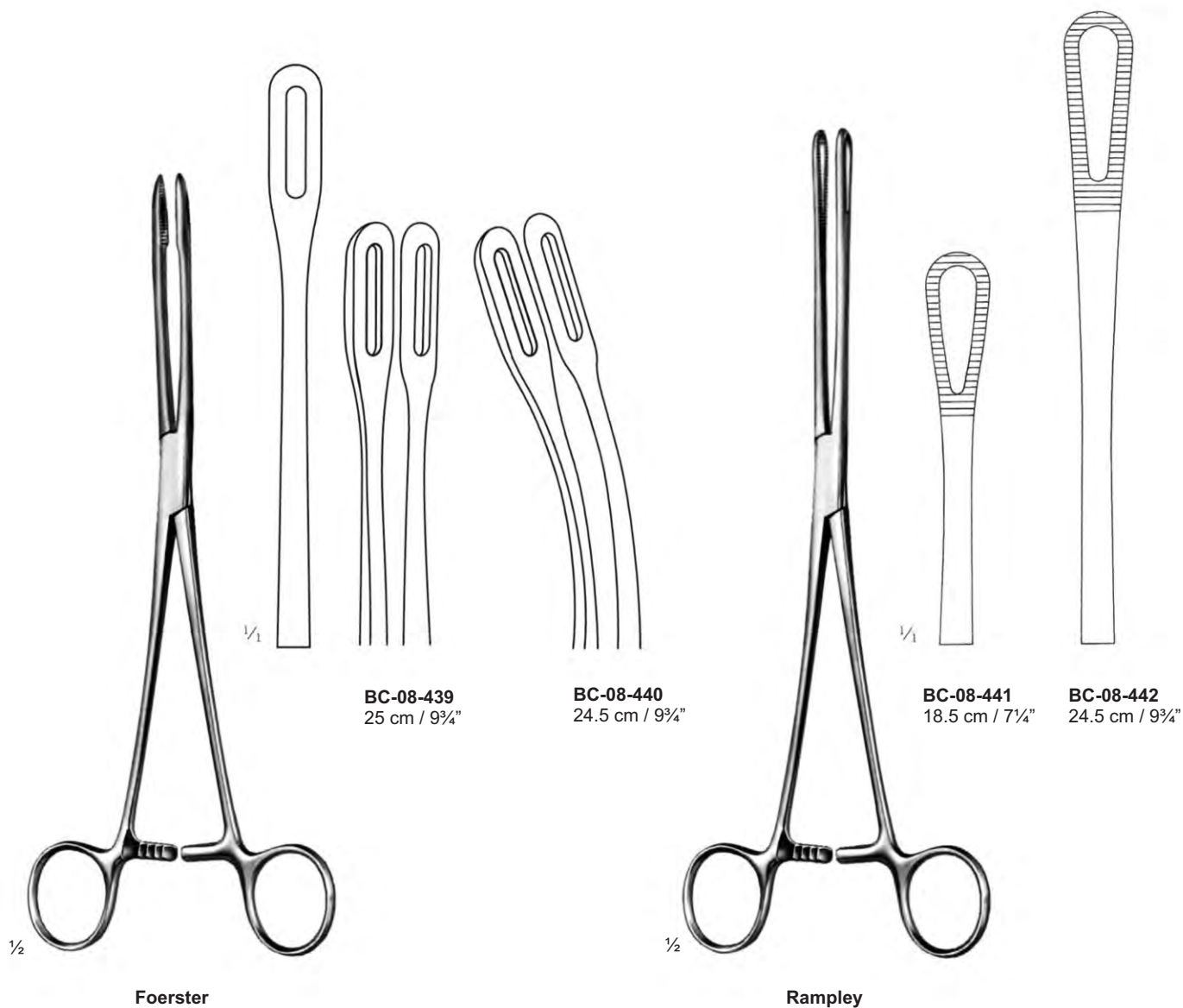



Bozemann
BC-08-443
26 cm / 10¼"

½



Bozemann
BC-08-444
26 cm / 10¼"

½



Fletcher (Javerts)
BC-08-445
24 cm / 9½"

½