



Serving Humanity Since 1908

**WELMED**  
INSTRUMENTS CO.

**ENT Catalogue  
Group 20, 21, 22, 23, 24 & 25**



**Manufacturers & Exporters of Quality Surgical Instruments**

**Anaesthesia, Otology, Rhinology, Tonsillectomy,  
Laryngo-Bronchoscopy, Oral Maxillo-Facial Surgery  
and Carnio-Maxillo-Facial Surgery Instruments**



# Oral 24

**WELMED Instruments Company**  
Defence Road  
Near Wapda Grid Colony  
Sialkot 51310, Pakistan.

Phone : +92 52 3554782, 3558704  
Fax : +92 52 3550296  
Cell : +92 333 8680640

Email : [info@welmedinst.com](mailto:info@welmedinst.com)  
[welmedpk@gmail.com](mailto:welmedpk@gmail.com)  
[wmm@brain.net.pk](mailto:wmm@brain.net.pk)  
[welmed@cyber.net.pk](mailto:welmed@cyber.net.pk)

Website : [www.welmedinst.com](http://www.welmedinst.com)

## About Us

Quality begins at **WELMED** Instruments Company where master craftsmen forge and manufacture each instrument to its exact specifications and measurements. Instruments must undergo a series of quality control inspections in order to be worthy of **WELMED** name and warranty. We offer a wide selection of medical instruments including Surgical and Dental instruments.

We have acquired a unique and unmatched understanding of manufacturing through a large experience, working since 1908. Years of experience & state of the art manufacturing facilities helped us to keep our prices low. Our Surgical & Dental instruments are created by expert craftsmen, providing unfaltering quality you can rely on.

We have launched a fully interactive website where you can get online and track your orders 24 hours a day, 7 days in a week, and 365 days a year. Ask for our free e-catalogue on CD-Rom to save time and enjoy hassle free ordering.

We provide our customers with most reliable customer service as your satisfaction is our top priority. Our customers always enjoy our wonderful customer service and quality tools at the best price.

Lastly we invite you to have a work experience with **WELMED** Instruments Company and we will prove ourselves as one of the most valuable source you have.

You can find us at

**WELMED Instruments Company**  
Defence Road, Near Wapda Grid Colony  
Sialkot 51310, Pakistan.

Phone : +92 52 3554782, 3558704  
Fax : +92 52 3550296  
Cell : +92 333 8680640

Emails :  
Info@welmedinst.com  
welmedpk@gmail.com  
wmm@brain.net.pk  
welmed@cyber.net.pk

Website : [www.welmedinst.com](http://www.welmedinst.com)



## History

**WELMED Instruments Company** was founded in 1995. Our Great Grandfather **Mian Muhammad Fazal Elahi** was the founder of M/s M.F. Elahi & Company (E.P.) Pvt. Ltd, established in 1908. WELMED is a sister concern of M.F. Elahi & Co. It is our pride to be a member of M.F. Elahi Family.

WELMED Instruments Company is located in the heart of beautiful city, Sialkot, Pakistan. We are manufacturers and exporters of quality Surgical, Dental instruments and Scissors of all sorts in various categories. We are closely attached with highly skilled surgeons and other technicians of the surgical industry to make the new instruments development possible.

WELMED is in a continues process of development and testing of new instruments for their precision and perfect functioning. We are also working at imported forging supply by foreign customers.

## Certificates

Welmed Instruments Company has achieved the certificates for ISO-9001, ISO-13485, cGMP (FDA) and CE Marking.

## Quality Control

All material use in the manufacturing of our instruments are tested from relevant laboratories. Our continuous quality control is our best warranty so that you built confidence in our products.

## Deliveries

Deliveries are quick and in-time.

## Mode Of Payment

Terms of Payment is ADVANCE or LETTER OF CREDIT (Irrevocable)

## Quality Policy

**WELMED Instruments Company** aims to produce quality Surgical, Dental instruments and Scissors of all sorts at reasonable prices to become an exemplary manufacturer. Our total emphasize is to achieve customer's satisfaction by clearly understanding their requirements and following a quality management system which is a primary concern of all our work force. We do our best to produce instruments of finest quality.



## Warranty

All WELMED Instruments are produced from finest stainless steel available to be free from any defect in material or workmanship. Any product that proves to be defective in material or workmanship will either be repaired or replaced without any charge. This warranty is void if the instrument is abused, altered, modified or is not used in the manner for which it is intended.

# Oral 24

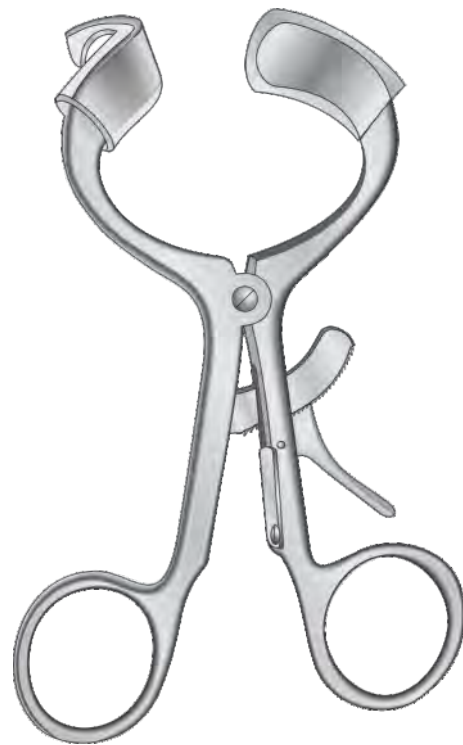

**WELMED**  
INSTRUMENTS CO.

Arnhem	200	Wolford	199,214
Bauer	201	Young	184
Bishop	181		
Brunings	183		
Collin	184		
Dautrey-munro	201		
Davis-boyle	177		
Denhart	174		
Dingmann	179,196		
Dingmann-wilk	196		
Doyen	183		
Dunn-dautrey	203		
Epker	202		
Epker-bauer	201		
Extra Oral Retractor	185		
Gillies	196		
Hargis Lip & Cheek Retractor	204		
Hargis With Chain	204,206,208		
Hargis	208		
Hartmann	182		
Heister	175		
Intra Oral Retractor	186		
Intra Oral Retractor	187		
Jaboma	216		
Jennings	180		
Jeter-van Sickels	197		
Keen	198		
Kilner-doughty	176		
Koberg, Mod.	192		
Martin	183		
Martin-simplex	181		
Mclvor	178		
Mershon	194		
Metz	191		
Molt	175		
MClvor	178		
Mouth Gags, Cheek Retracto	180		
Obwegeser Nasal Spine	190		
Obwegeser	175,181,189,190,192,194		
Roser-konig	174		
Rowe	195		
Sakamoto	199		
Salyer	199,216		
Schuchardt	191		
Shin Lift Curettes	172,173		
Smith	207		
Steinhauser Extra Long Muy	212		
Steinhauser Reposition	211		
Steinhauser	198,211,215		
Sternberg	181		
Terry	171,209		
Tery	210		
Tobold	182		
Tongue Spatulas	183		
Turvey	209		
Wieder	182		

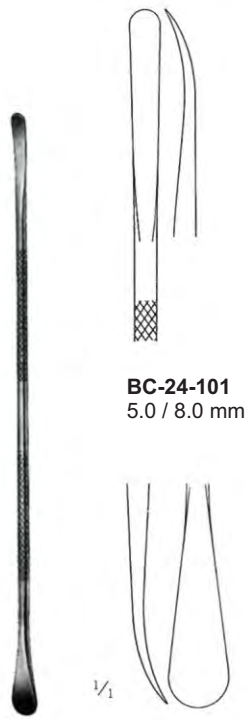

**BC-24-101**  
 5.0 / 8.0 mm

**Terry**  
 17 cm / 6 3/4"  
 for elevation of alveolar flaps  
 para la elevacion de las aletas alveolares  
 pour elevation du lambeau alveolaire



**BC-24-102**  
 11 cm / 4 1/4"

**Terry**  
**Graft Packe**  
 Atacador de trasplantes  
 Poussoir pour transplantation

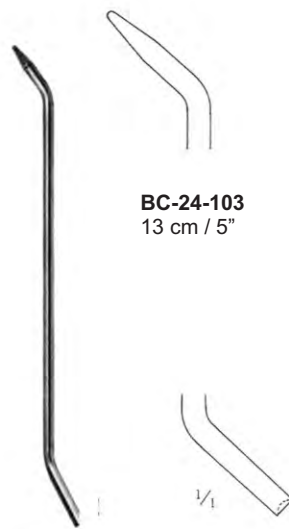

**BC-24-103**  
 13 cm / 5"

**Graft Packe**  
 Atacador de trasplantes  
 Poussoir pour transplantation



**BC-24-104**  
 3.0 - 7.0 mm

**Terry**  
 18 cm / 7"  
 for subperiosteal tunnels  
 para tuneles subperiosticos  
 pour tunnel subperiostal





**BC-24-105**  
18 cm / 7"  
2.6 / 2.6 mm

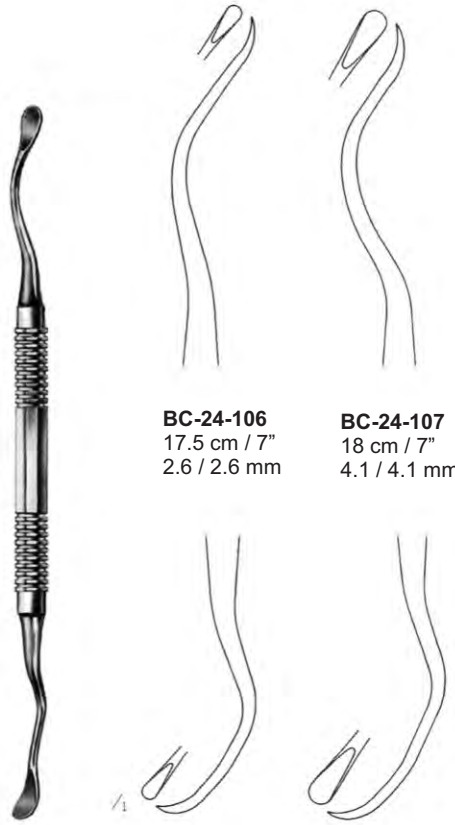

**BC-24-106**  
17.5 cm / 7"  
2.6 / 2.6 mm

**BC-24-107**  
18 cm / 7"  
4.1 / 4.1 mm

**BC-24-108**  
18.5 cm / 7 1/4"  
4.1 / 4.1 mm

**BC-24-109**  
19 cm / 7 1/2"  
6.7 / 6.7 mm



**BC-24-110**  
18.5 cm / 7 1/4"  
6.7 / 6.7 mm



**BC-24-111**  
16 cm / 6 1/4"  
2.8 / 6.2 mm

**BC-24-112**  
16 cm / 6 1/4"  
2.8 / 6.2 mm

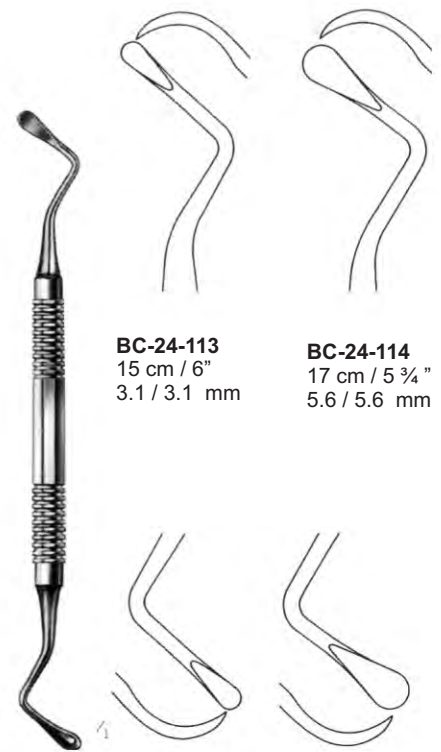

**BC-24-113**  
15 cm / 6"  
3.1 / 3.1 mm

**BC-24-114**  
17 cm / 5 3/4"  
5.6 / 5.6 mm

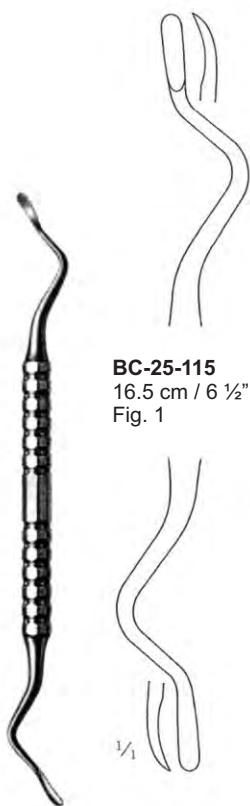

**BC-25-115**  
16.5 cm / 6 1/2"  
Fig. 1



**BC-25-116**  
16.5 cm / 6 1/2"  
Fig. 2

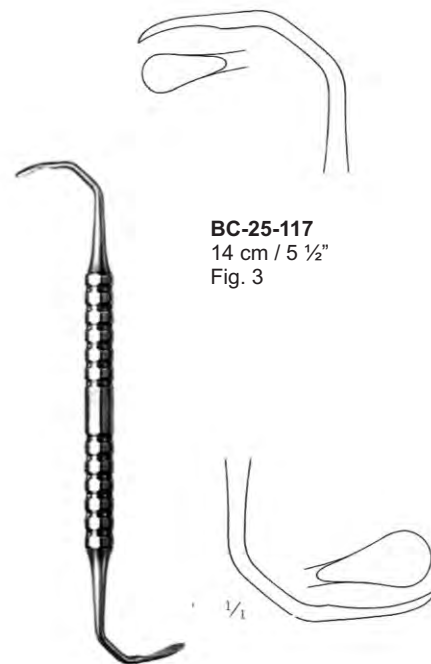

**BC-25-117**  
14 cm / 5 1/2"  
Fig. 3

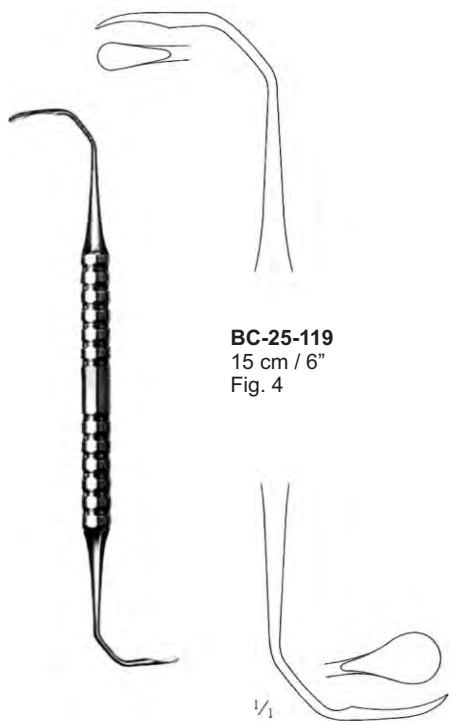

**BC-25-119**  
15 cm / 6"  
Fig. 4

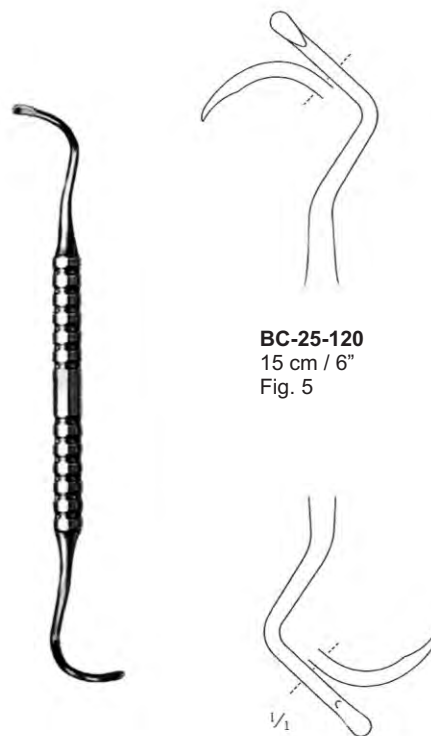

**BC-25-120**  
15 cm / 6"  
Fig. 5



**BC-24-124**  
13 cm / 5"  
jaw  
bocas  
mors  
  
16 mm

Denhart

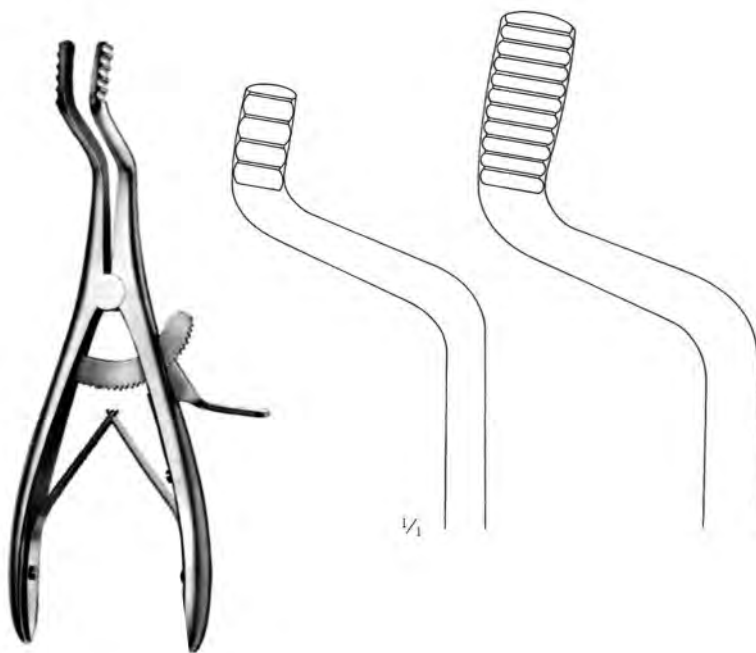

Roser-Konig

**BC-24-125**  
16 cm / 6 1/4"

**BC-24-126**  
20 cm / 8"



**Heistetr**  
BC-24-127  
13 cm / 5"



**Obwegeser**  
BC-24-128  
11 cm, / 4 ¼"



**Molt**  
BC-24-129  
11 cm / 4 ¼"



**Molt**  
BC-24-130  
13 cm / 5"



Kilner-Doughy

**BC-24-131**

complete with frame, 3 tongue depressors  
2 tooth plates and 1 palate plate  
completo con bistidor, 3 bajalenguas,  
2 plaquitas de dientes y 1 plaquita paladia  
complete avec cadre, 3 abaisse-langue v,  
2 plaques pour dents et 1 plaque palatina

**BC-24-132**

14.5 cm / 5 3/4"  
Frame for Mouth Gag  
Bastidor para abrebooca  
Cadre pour ouvre-bouche



**BC-24-133**  
13.5 cm / 5 1/4"  
70 x 29 mm



**BC-24-134**  
13.5 cm / 5 1/4"  
80 x 34 mm



**BC-24-135**  
13.5 cm / 5 1/4"  
85 x 38 mm

Kilner-Doughy  
tongue Depressor  
Bajalengua  
Abaisse-langue

Fenestrated blade for suction  
hoja fenestrada para succion  
lame fenetree pour aspiration



**Bc-24-136**  
complete, consisting of frame and five tongue depressors no. 1 to 5  
completo, consiste de bastidory y cinco bajalenguas number 1 hasta 5  
complet, dse composant de cadre et cinq abaisse-langue number 1 jusqu'a 5

**BC-24-137**  
Frame for Mouth gag  
Bastidor para abreboaca  
Cadre pour ouver-bouche



**BC-24-138**  
13.5 cm / 5 1/4"  
110 x 26 mm



**BC-24-139**  
13.5 cm / 5 1/4"  
95 x 25 mm



**BC-24-140**  
13.5 cm / 5 1/4"  
80 x 24 mm



**BC-24-141**  
13.5 cm / 5 1/4"  
65 x 23 mm



**BC-24-142**  
13.5 cm / 5 1/4"  
30 x 20 mm  
without suction tube  
sin tubo de succion fijo  
sans tube d'aspiration fixe

**Davis-Boyle**

tongue depressor  
Bajalengua  
Abaisse-langue

With fixed suction tube  
con tubo de succion fijo  
avec tube d'aspiration fixe

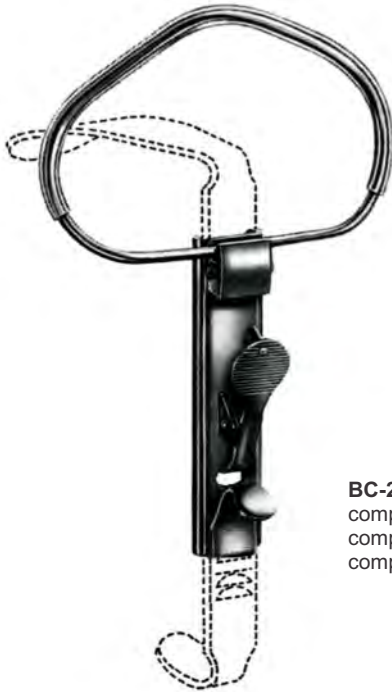

Mclvor

**BC-24-143**  
complete  
completo  
complet

**BC-24-144**  
15 cm / 6"  
Frame for Mouth Gag  
Bastidor para abreboza  
ouver-bouche

65 x 100 mm



Mclvor  
Tongue Depressor  
Bajalengua  
Abaisse-langue

**BC-24-145**  
13.5 cm / 5 1/4"  
100 x 26 mm



**BC-24-146**  
13.5 cm / 5 1/4"  
85 x 25 mm

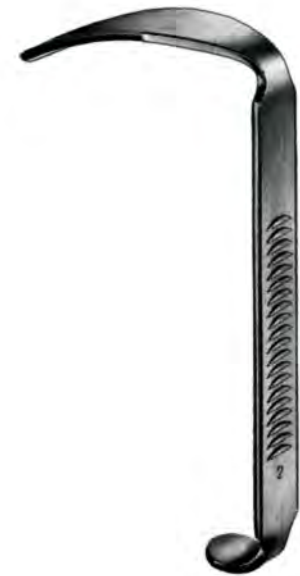

**BC-24-147**  
13.5 cm / 5 1/4"  
75 x 23 mm



**BC-24-148**  
14.5 cm / 5 3/4"  
complete with frame, 3 tongue depressors  
and 2 adjustable lateral blades  
complete con bastidor, 3 bajalenguasy y 2  
valvas laterales ajustables  
complet avec cadre, 3 abaisse-langueet 2  
valves laterales réglables

Dingmann



Dingmann  
Tongue depressor  
Bajalengua  
Abaisse-angue

**BC-24-149**  
13.5 cm / 5 1/4"  
65 x 25 mm



**BC-24-150**  
13.5 cm / 5 1/4"  
70 x 29 mm



**BC-24-151**  
13.5 cm / 5 1/4"  
80 x 32 mm





**Jennings**

- BC-24-152** 10.5 cm / 4"
- BC-24-153** 12.5 cm / 5"
- BC-24-154** 14.5 cm / 5¾"
- BC-24-155** 16.5 cm / 6½"



**BC-24-156**  
15 cm / 6"  
20 mm



**BC-24-157**  
14.5 cm / 5¾"  
fenestrated  
fenestrado  
fenetre



**Martin-Simplex**  
**BC-24-158**  
10.5 cm / 4"



**BC-24-159**  
14 cm / 5 1/2"  
Vestibulum Retractor  
Separador para vestibulo  
Ecarteur pour vestibulum



**Sternberg**  
**BC-24-160**  
14 cm / 5 1/2"  
26 / 37 mm

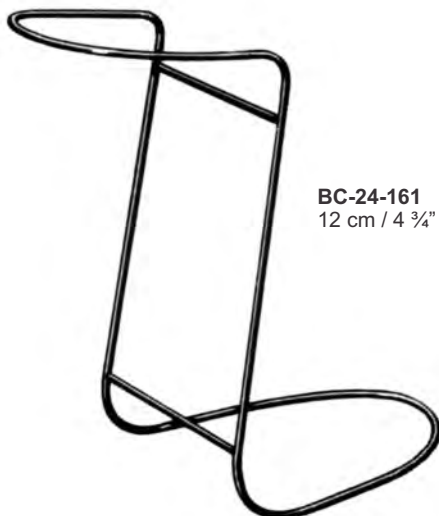

**BC-24-161**  
12 cm / 4 3/4"

**Obwegeser**



**BC-24-162**  
13.5 cm / 5 1/4"  
27 mm

**Bishop**

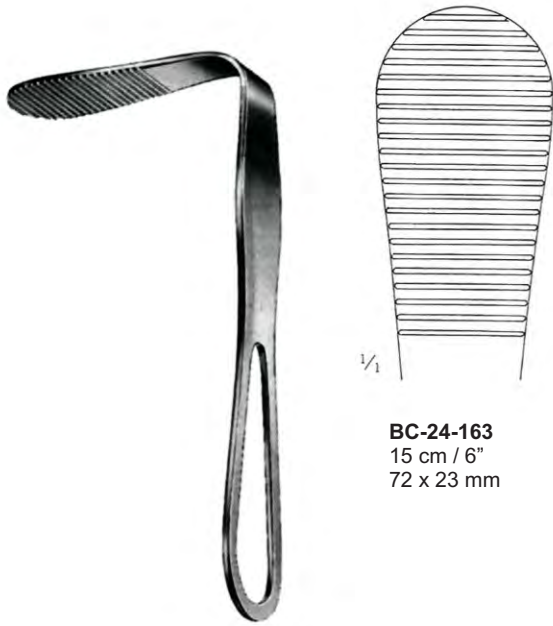

1/1

**BC-24-163**  
15 cm / 6"  
72 x 23 mm

Hartmann



1/1

**BC-24-164**  
15 cm / 6"  
88 x 25 mm

Tobold



1/1

**BC-24-165**  
14.5 cm / 5 3/4"  
85 x 24 mm

Tobold



1/1

**BC-24-166**  
14 cm / 5 1/2"  
36 mm

Wieder

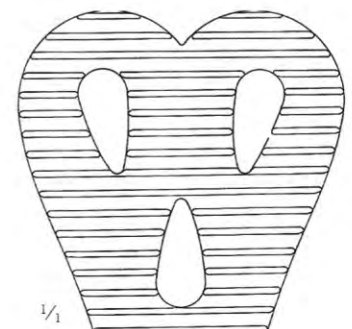

1/1

**BC-24-167**  
15 cm / 6"  
43 mm



**BC-24-168**  
16 cm / 6 ¼"  
package of 100 pieces wood  
paquete con 100 piezas madera  
paquet de 100 pieces  
bois



**BC-24-169**  
15 cm / 6"  
package of 100 pieces plastic  
paquete con 100 piezas plastico  
paquet de 100 pieces  
plastique



**BC-24-170**  
18.5 cm / 7 ½"  
nylon  
nilon  
nylon

Martin



Doyen

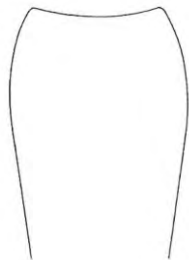

**BC-24-171**  
13.5 cm / 5 ¼"  
24 / 30 mm

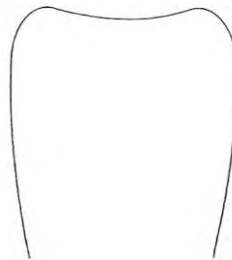

**BC-24-172**  
16 cm / 6 ¼"  
30 / 34 mm

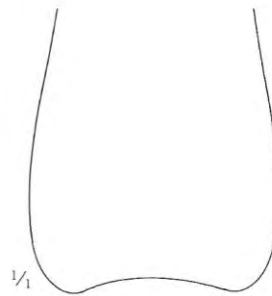
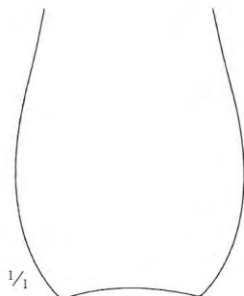

Bruning

**BC-24-173**  
19 cm / 7 ½"  
19 / 15 mm



**BC-24-174**  
17 cm / 6 3/4"  
jaw 24 x 27 mm  
boca 24 x 27 mm  
mors 24 x 27 mm

Collin

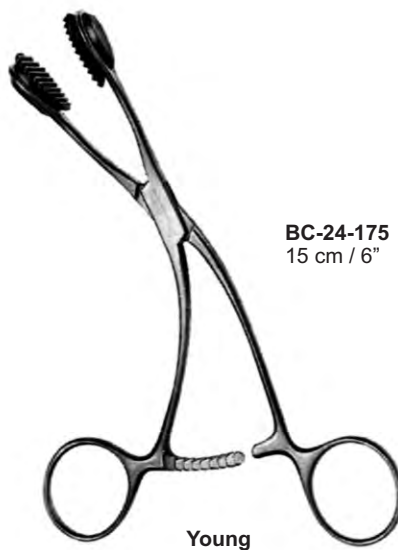

**BC-24-175**  
15 cm / 6"

Young

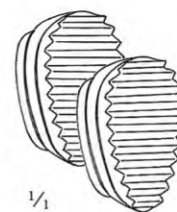

**Young**  
**BC-24-176**  
23 x 15 mm  
rubber inserts  
Bocas de goma  
Mors en acoutchouc  
Pair  
par  
paire



**BC-24-177**  
22 cm / 8 ¾"  
9.5 mm / 16 mm  
concave blade, fully bent tip  
hoja concava, fuertemente curva  
lame concave, courbe énormément

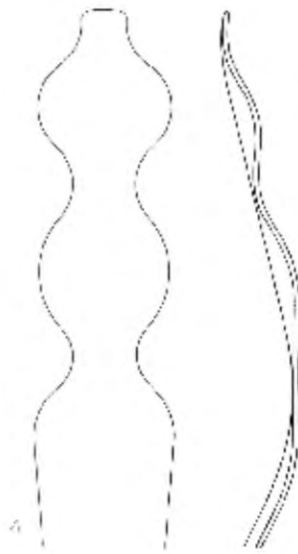

**BC-24-179**

23 cm / 9"  
25.5 mm  
for LeFort osteotomies  
para osteotomias segun LeFort  
Pour osteotomis selon LeFort

With fiber optic light carrier. Con conexion de luz fria. Avec connection lumiere froide

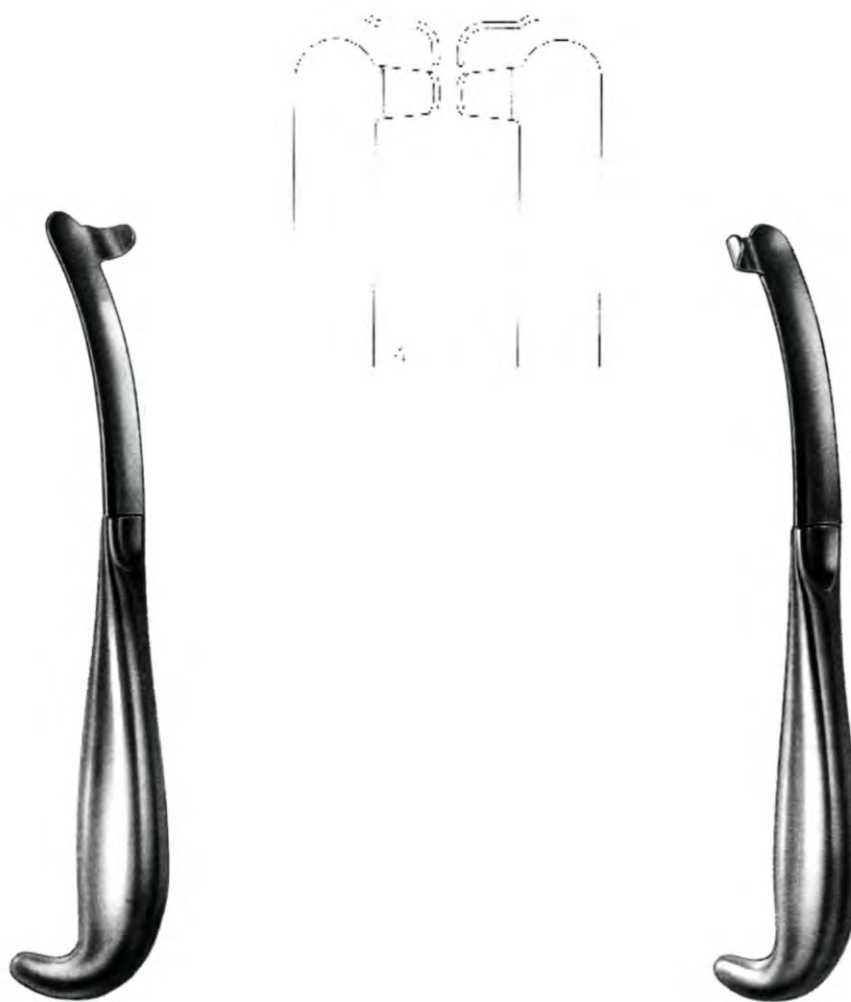

**BC-24-181**  
21 cm / 8 ¼"  
26.5 / 16 mm  
right  
derecha  
droite

**BC-24-182**  
21 cm / 8 ¼"  
26.5 / 16 mm  
left  
izquierdo  
gauche



With fiber optic light carrier. Con conexion de luz fria. Avec connection lumiere froide



**BC-24-185**  
25 cm / 9 3/4"  
12.5 - 27 mm  
L&M, for vertical osteotomy  
L&M, paraosteotomia vertical  
L&M, pour osteotomie verticale

**BC-24-186**  
28 cm / 11"  
12.5 - 27 mm  
L&M, for vertical osteotomy  
L&M, paraosteotomia vertical  
L&M, pour osteotomie verticale



**BC-24-188**  
21.5 cm / 8 1/2"  
43 x 11 mm

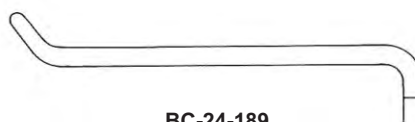

**BC-24-189**  
21.5 cm / 8 1/2"  
57 x 11 mm

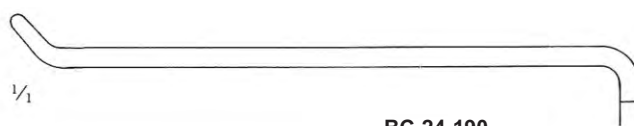

**BC-24-190**  
21.5 cm / 8 1/2"  
83 x 16 mm



Obwegeser

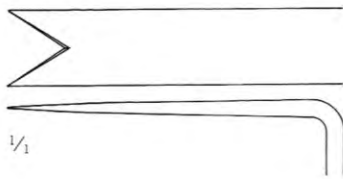

Obwegeser

**BC-24-191**  
22 cm / 8 3/4"  
Nasal Spine Retractor  
Separador para spine nasalis  
Ecarteur pour spina nasalis

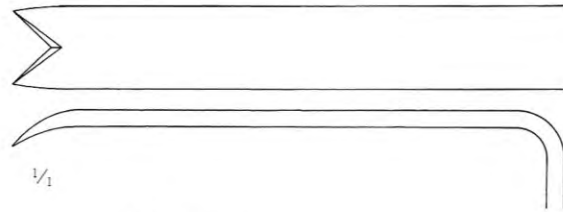

Obwegeser

**BC-24-192**  
22 cm / 8 3/4"  
72 x 10 mm

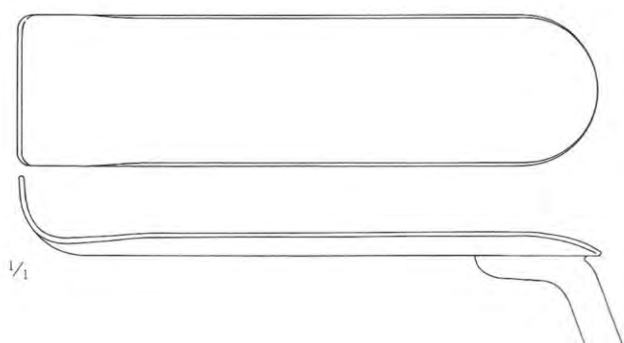

**BC-24-193**  
15 cm / 6"



**Schuchardt**

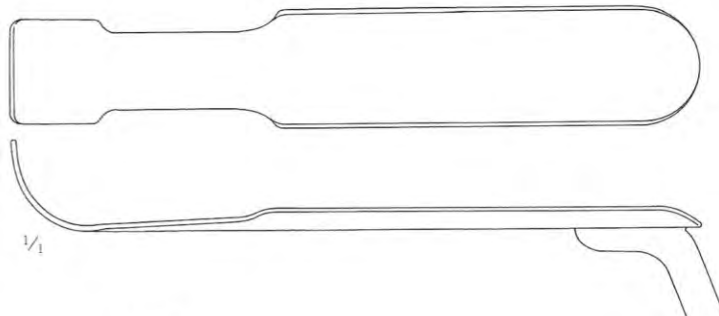

**BC-24-194**  
15 cm / 6"



**Metz**



**Obwegeser**  
**BC-24-195**  
16.5 cm / 6 1/2"



**Obwegeser**  
**BC-24-196** 17 cm / 6 3/4" 8 mm  
**BC-24-197** 17 cm / 6 3/4" 10 mm



**BC-24-198**  
18.5 cm / 7 1/4"  
14 x 7 mm

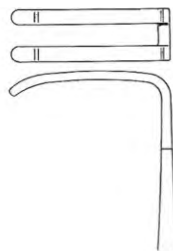
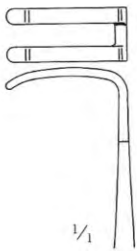

**Koberg, mod.**  
**BC-24-199**  
18.5 cm / 7 1/4"  
20 x 7 mm



**BC-24-200**  
18 cm / 7"  
3 x 18 mm



**BC-24-201**  
18 cm / 7"  
3.5 x 23 mm

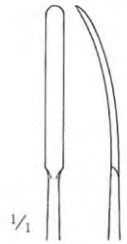



Obwegeser



**BC-24-202**  
 17.5 cm / 7 "  
 6 mm



**BC-24-203**  
 17.5 cm / 7 "  
 7 mm



**BC-24-204**  
 17.5 cm / 7 "  
 9 mm



**BC-24-205**  
 17.5 cm / 7 "  
 11 mm



Obwegeser



**BC-24-206**  
 20.5 cm / 8 "  
 5 mm



**BC-24-207**  
 20.5 cm / 8 "  
 7 mm



**BC-24-208**  
 20.5 cm / 8 "  
 9 mm

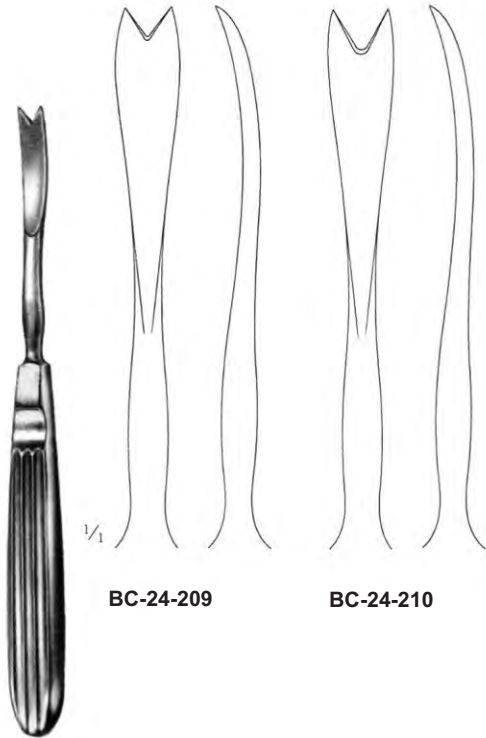

**Obwegeser**  
17.5 cm / 7 "

**BC-24-209**

**BC-24-210**

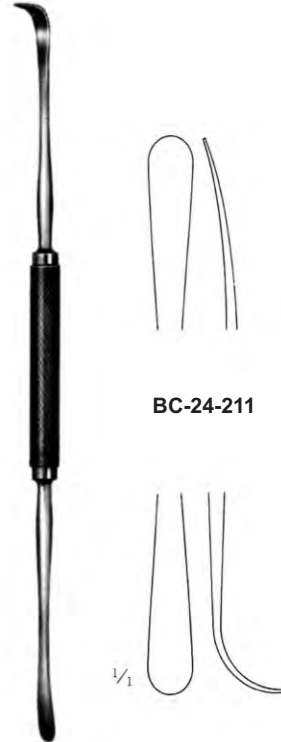

**Obwegeser**  
20.5 cm / 8 "

**BC-24-211**

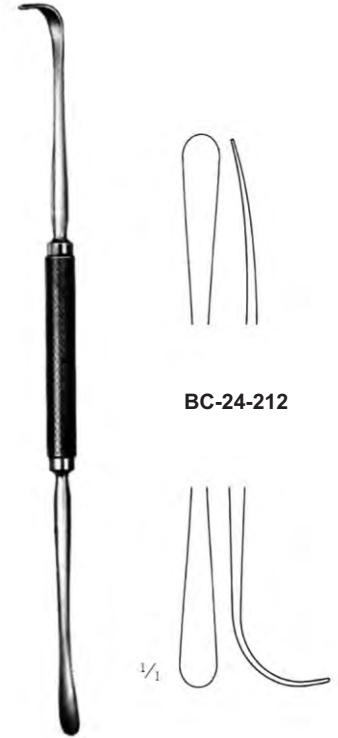

**Obwegeser**  
20.5 cm / 8 "

**BC-24-212**

Wire Pushers - Empujadores de alambres - Outil de positionnement



**BC-24-213**  
17 cm / 6 3/4"



**BC-24-214**  
15 cm / 6"

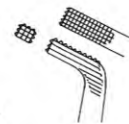

**BC-24-215**  
15 cm / 6"



**Rowe**



**Mershon**

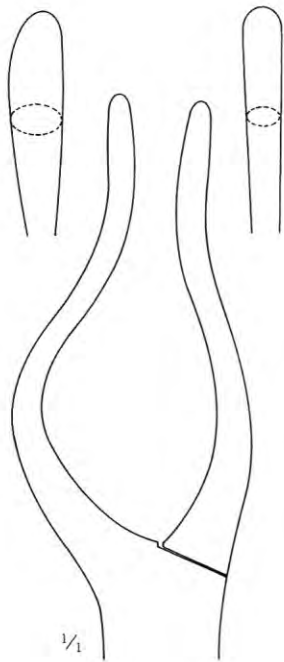

BC-24-216 L  
 BC-24-217 R

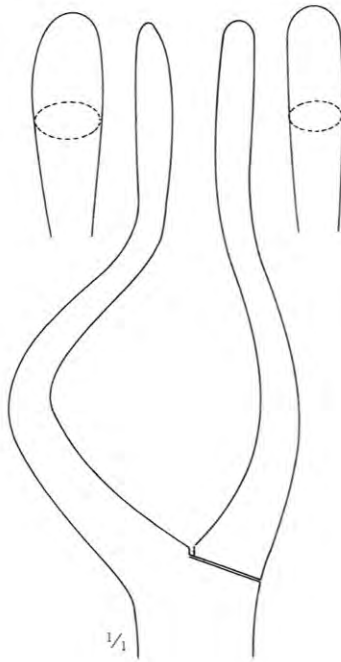

BC-24-218 L  
 BC-24-219 R

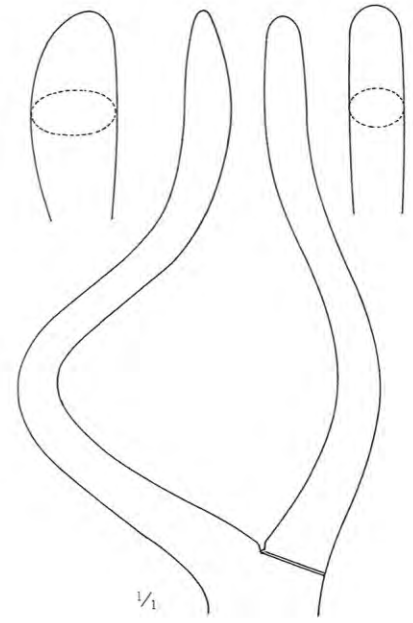

BC-24-220 L  
 BC-24-221 R



**Rowe**  
 22.5 cm / 9"  
 left  
 izquierdo  
 gauche  
 L



**Rowe**  
 24 cm / 9 1/2"  
 right  
 derecha  
 droite  
 R



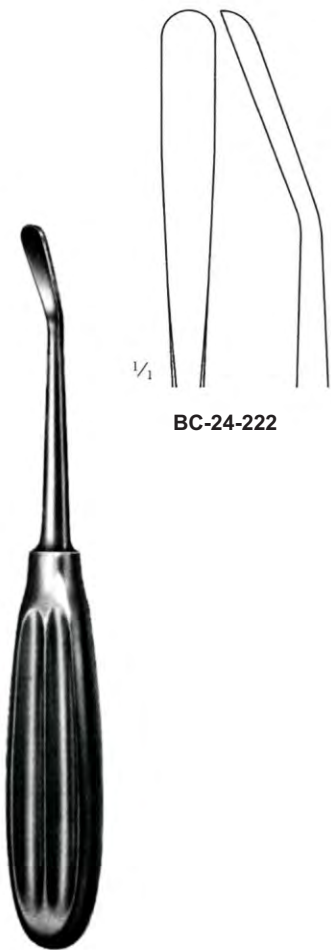

BC-24-222

Gillies  
20 cm / 8"



BC-24-223  
5.0 mm  $\varnothing$   
tip  
punta  
pointe

Dingmann  
21 cm / 8  $\frac{1}{4}$ "



BC-24-224

Dingmann-Wilk  
20 cm / 8"

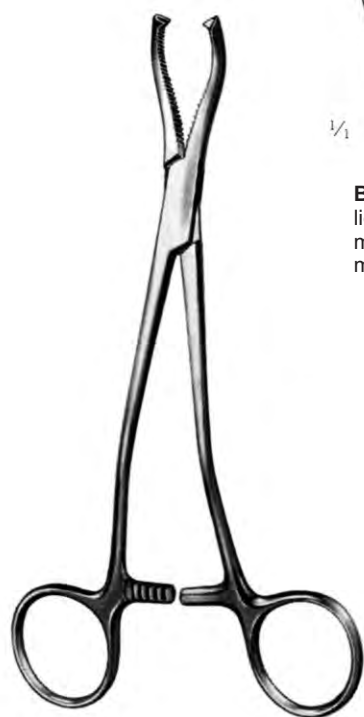

**Jeter-Van Sickels**  
18 cm / 7"  
for sagittal split procedure  
para uso en el sagital split  
pour fente sagittale

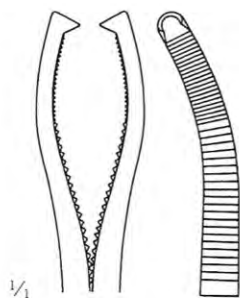

1/1

**BC-24-225**  
light pattern  
modelo ligero  
modele leger

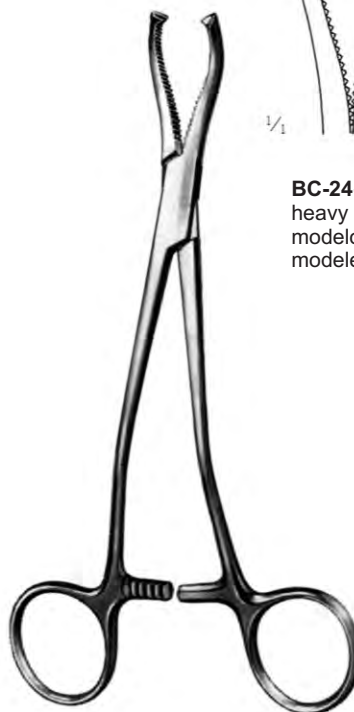

**Jeter-Van Sickels**  
18 cm / 7"  
for sagittal split procedure  
para uso en el sagital split  
pour fente sagittale

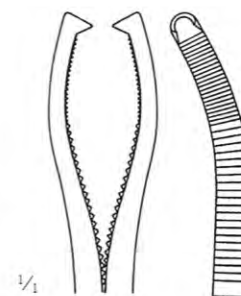

1/1

**BC-24-226**  
heavy pattern  
modelo fuerte  
modele fort

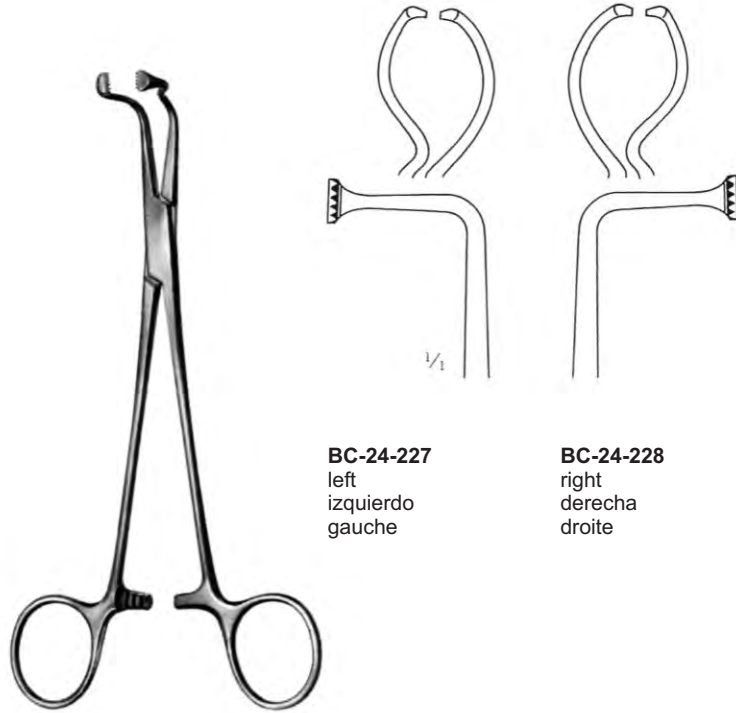

**Keen**  
17.5 cm / 6 3/4"

**BC-24-227**  
left  
izquierdo  
gauche

**BC-24-228**  
right  
derecha  
droite



**Steinhauser**  
**BC-24-229**  
13 cm / 5"



**Steinhauser**  
**BC-24-230**  
13 cm / 5"



**BC-24-231**  
25 cm / 10"

**Welford**



**BC-24-232**  
16 cm / 6 1/2"

**Salyer**



**Sakamoto**  
**BC-24-233**  
14 cm / 5 1/2"  
Measuring Forceps  
Pinzas para medir  
Pinces pour mesurer

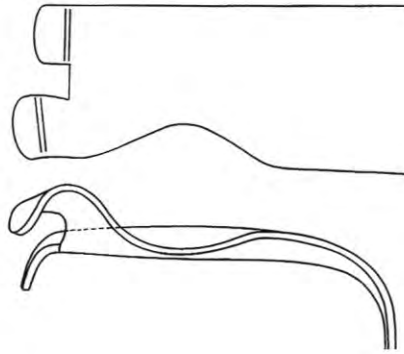

**BC-24-234**  
left  
izquierdo  
gauche

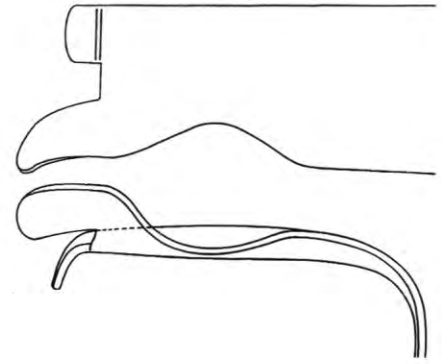

**BC-24-235**  
left  
izquierdo  
gauche

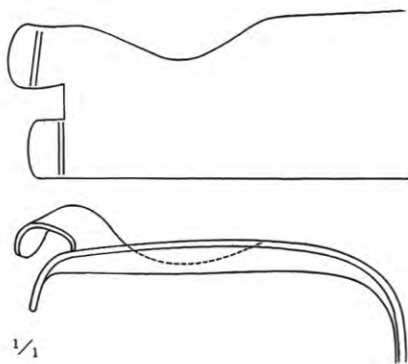

**BC-24-236**  
right  
derecha  
droite

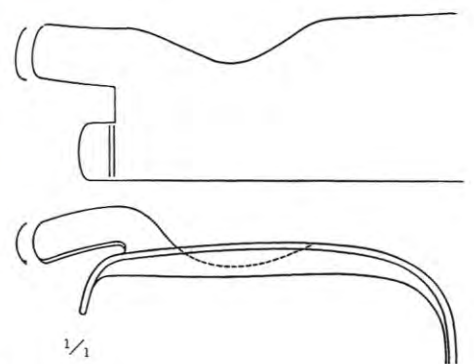

**BC-24-237**  
right  
derecha  
droite



**Arnhem**  
22 cm / 8 3/4"  
LeFort I Retractor  
Gancho de LeFort I  
Crochet de LeFort I

**Arnhem**  
22 cm / 8 3/4"  
Sinus lift Retractor  
Gancho para seno  
Crochet pour sinus



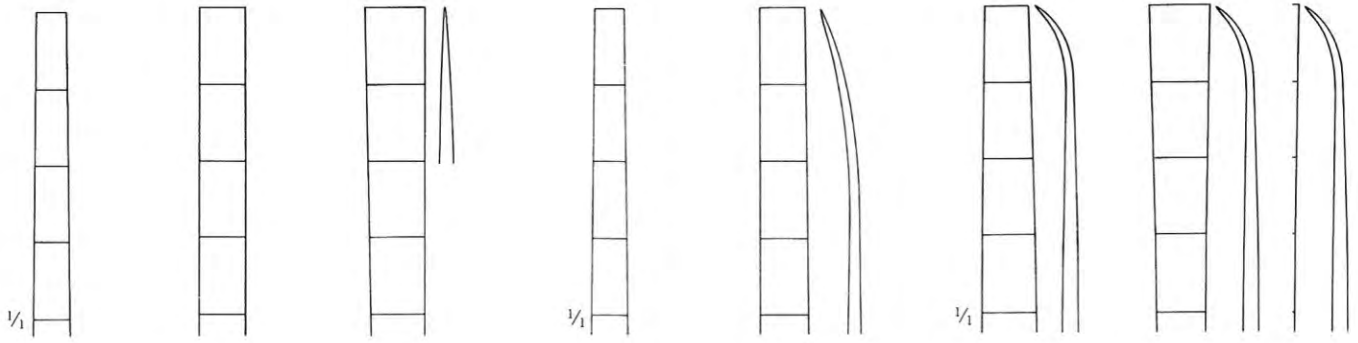

**BC-24-250**  
18 cm / 7"  
4 x 1.2 mm

**BC-24-251**  
18 cm / 7"  
6 x 1.2 mm

**BC-24-252**  
18 cm / 7"  
8 x 1.2 mm

**BC-24-253**  
18 cm / 7"  
4 x 1.2 mm

**BC-24-254**  
18 cm / 7"  
6 x 1.2 mm

**BC-24-255**  
18 cm / 7"  
6 x 1.2 mm

**BC-24-256**  
18 cm / 7"  
8 x 1.2 mm



Epker



Epker



Epker



**BC-24-257**  
16.5 cm / 6 1/2"  
4 mm

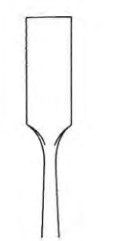

**BC-24-258**  
16.5 cm / 6 1/2"  
6 mm



**BC-24-259**  
16.5 cm / 6 1/2"  
8 mm



**BC-24-260**  
17 cm / 6 3/4"  
6 mm



**BC-24-261**  
17 cm / 6 3/4"  
6 mm

Dunn-Dautrey

Dunn-Dautrey



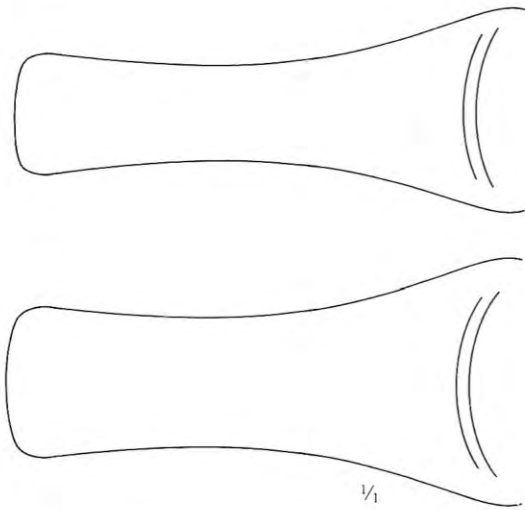

1/4



**BC-24-262**  
16 cm / 6 1/4"

**Hargis**  
Lip and Cheek Retractors  
Separadores para labios y mejillas  
Ecarteurs pour levres et joues



**Hargis**

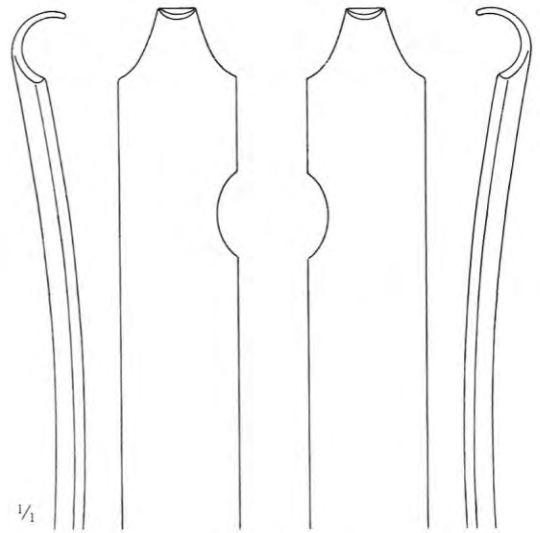

1/4

**BC-24-263**  
19.5 cm / 7 3/4"  
right  
derecha  
droite

**BC-24-264**  
19.5 cm / 7 3/4"  
left  
izquierdo  
gauche



**BC-24-265**  
18 cm / 7"

Hargis



**BC-24-266**  
19 cm / 7 1/2"

Hargis

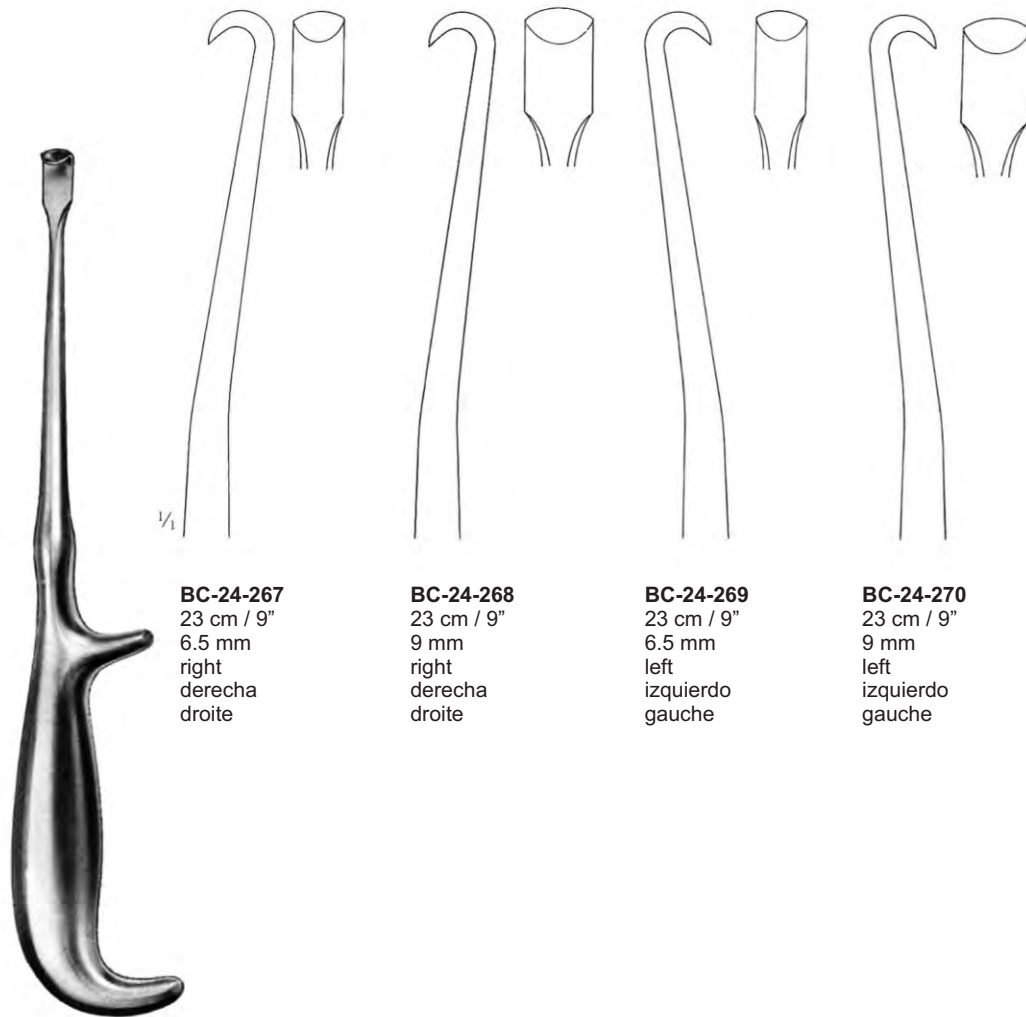

**Hargis**

**BC-24-267**  
23 cm / 9"  
6.5 mm  
right  
derecha  
droite

**BC-24-268**  
23 cm / 9"  
9 mm  
right  
derecha  
droite

**BC-24-269**  
23 cm / 9"  
6.5 mm  
left  
izquierdo  
gauche

**BC-24-270**  
23 cm / 9"  
9 mm  
left  
izquierdo  
gauche

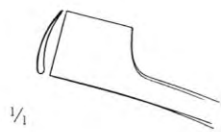

Smith

**BC-24-271**  
18.5 cm / 7 1/4"  
9 mm  
right  
dereche  
droite

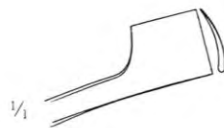

Smith

**BC-24-272**  
18.5 cm / 7 1/4"  
9 mm  
left  
izquierdo  
gauche



Smith



**BC-24-273**  
23.5 cm / 9 1/4"



Hargis

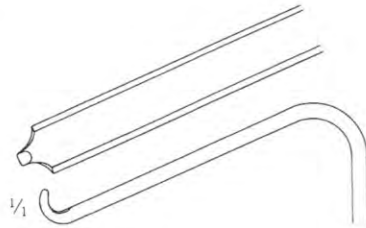

**BC-24-274**  
18.5 cm / 7 1/4"



Hargis

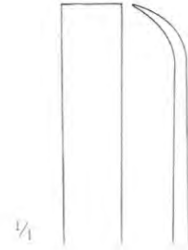

**BC-24-275**  
22 cm / 8 3/4"

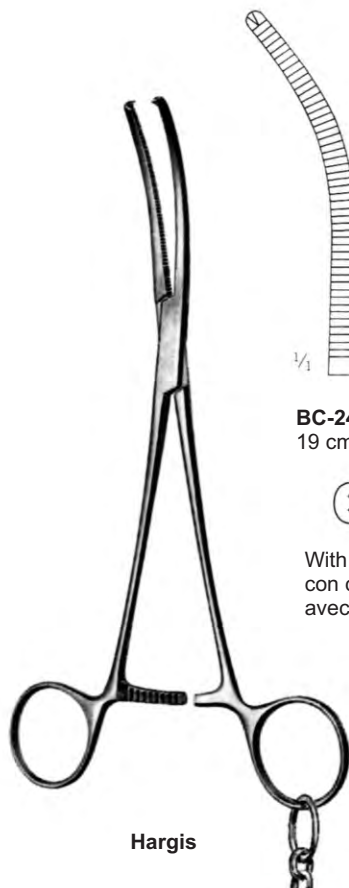

Hargis



**BC-24-276**  
19 cm / 7 1/2"



With chain  
con cadena  
avec chaine

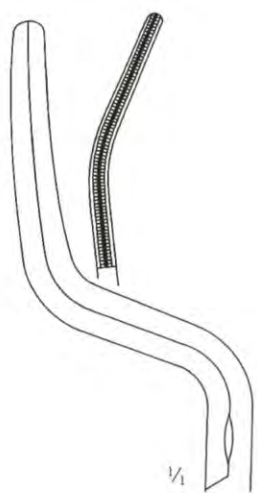

1/1

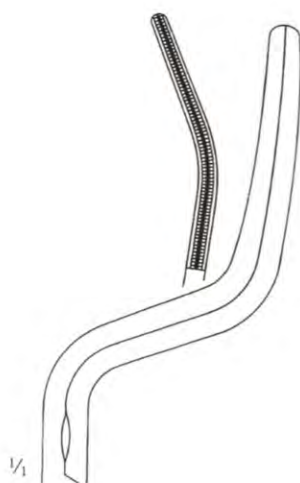

1/1



1/1

**BC-24-277**  
17 cm / 6 3/4"  
left  
izquierdo  
gauche

**BC-24-278**  
17 cm / 6 3/4"  
right  
derecha  
droite

**BC-24-279**  
17 cm / 6 3/4"



Terry



Terry



Turvey



Terry

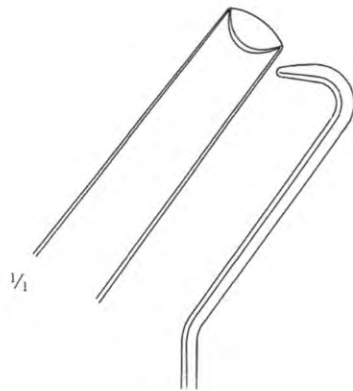

**BC-24-280**  
16.5 cm / 6 1/2"



Terry



**BC-24-281**  
24 cm / 9 1/2"

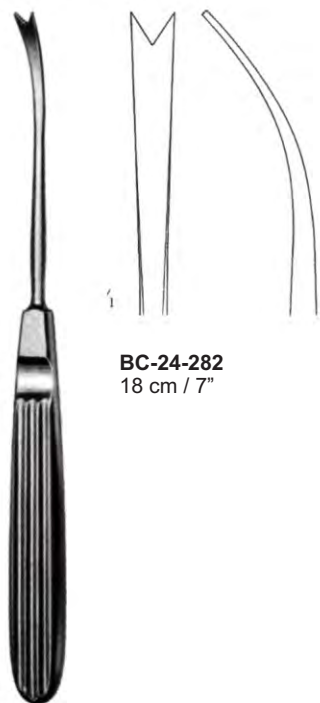

**BC-24-282**  
 18 cm / 7"

**Steinhauser**  
 reposition Instrument;  
 Instrumento de reposicion  
 Instrument de reposition

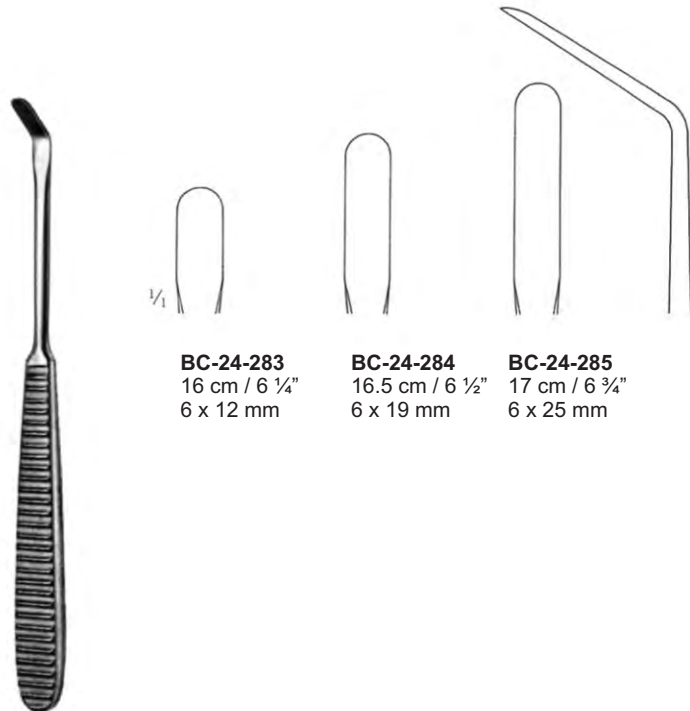

**BC-24-283**  
 16 cm / 6 1/4"  
 6 x 12 mm

**BC-24-284**  
 16.5 cm / 6 1/2"  
 6 x 19 mm

**BC-24-285**  
 17 cm / 6 3/4"  
 6 x 25 mm

**Steinhauser**

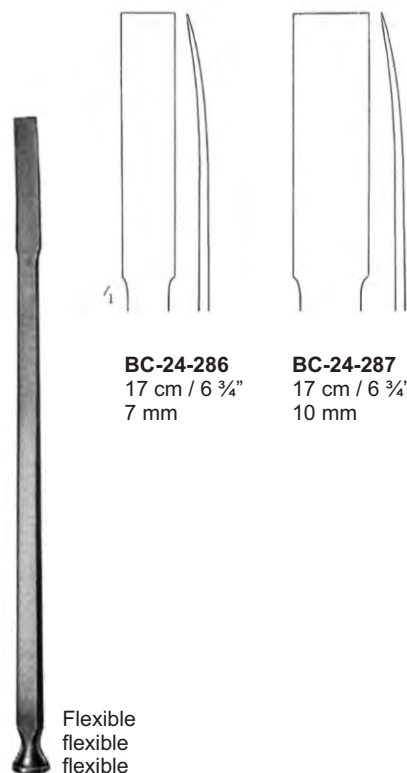

**BC-24-286**  
 17 cm / 6 3/4"  
 7 mm

**BC-24-287**  
 17 cm / 6 3/4"  
 10 mm

Flexible  
 flexible  
 flexible

**Steinhauser**

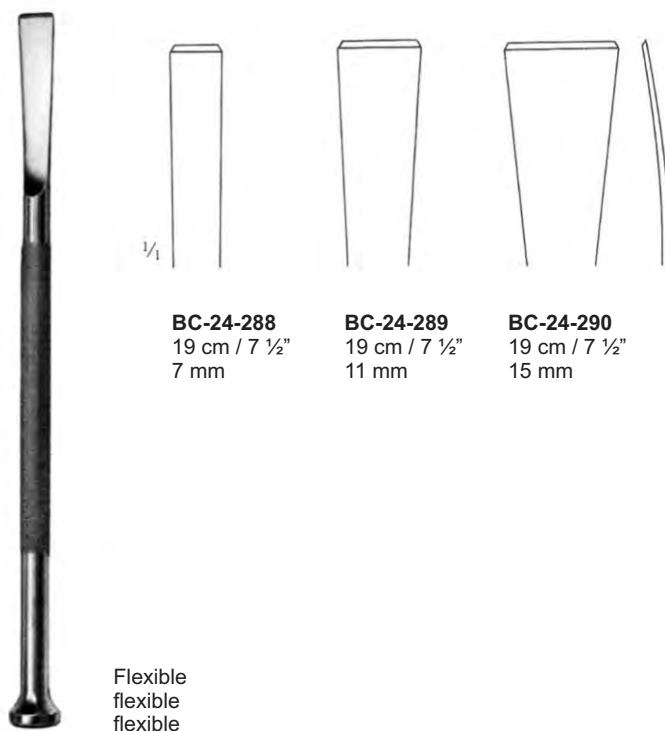

**BC-24-288**  
 19 cm / 7 1/2"  
 7 mm

**BC-24-289**  
 19 cm / 7 1/2"  
 11 mm

**BC-24-290**  
 19 cm / 7 1/2"  
 15 mm

Flexible  
 flexible  
 flexible

**Steinhauser**



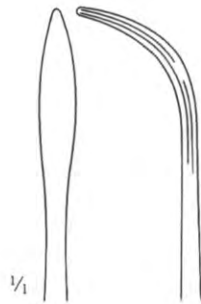

**BC-24-291**  
18.5 cm / 7 1/4"

Steinhauser

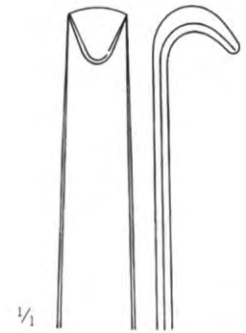

**BC-24-292**  
27 cm / 10 1/2"  
extra long  
muy largo  
tres long

Steinhauser

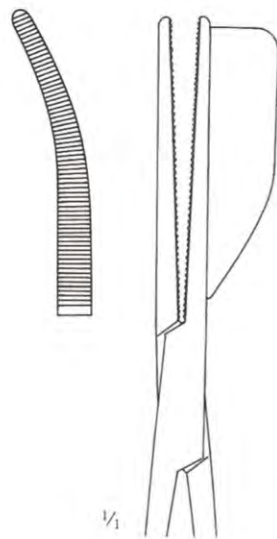

**BC-24-293**  
16 cm / 6 1/4"  
right  
derecha  
droite



**Steinhauser**

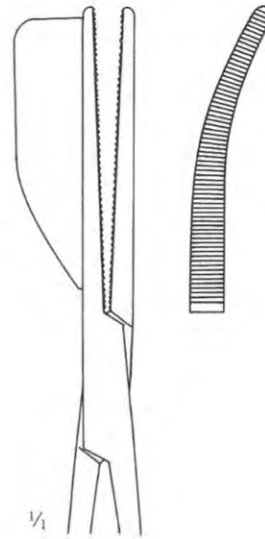

**BC-24-294**  
16 cm / 6 1/4"  
left  
izquierdo  
gauche



**Steinhauser**



**BC-24-295**  
16.5 cm / 6 1/2"  
3 mm

Steinhauser

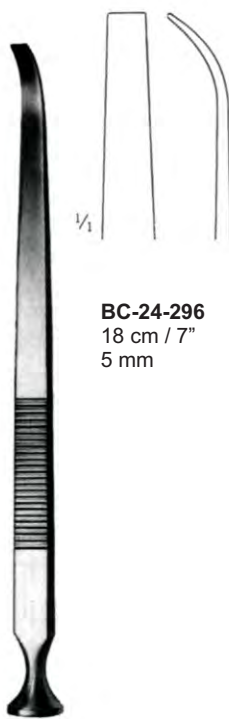

**BC-24-296**  
18 cm / 7"  
5 mm

Steinhauser

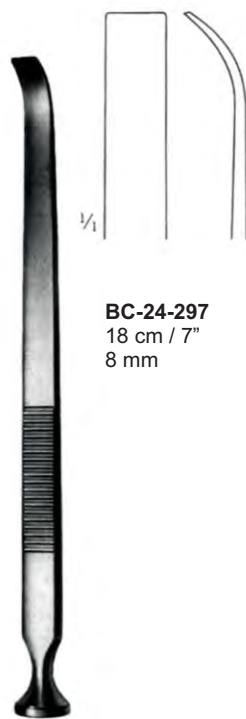

**BC-24-297**  
18 cm / 7"  
8 mm

Steinhauser



**BC-24-298**  
23 cm / 9"  
6 mm

Wolford

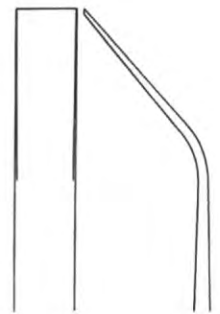

**BC-24-299**  
23 cm / 9"  
8 mm



Steinhauser

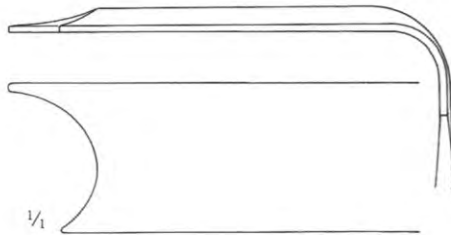

**BC-24-300**  
23 cm / 9"  
20 x 50 mm  
right  
derecho  
droite

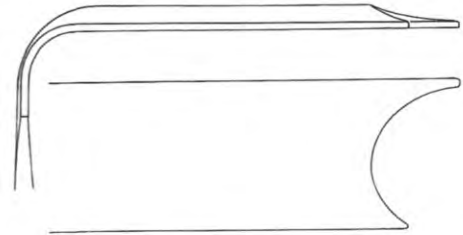

**BC-24-301**  
23 cm / 9"  
20 x 50 mm  
left  
izquierdo  
gauche



**Salyer  
BC-24-302**  
18.5 cm / 7 1/4"  
Cleft Palate Hooklets  
Ganchito para el paladar  
Crochet pour palais

Short blade  
hoja corta  
lame courte



**Salyer  
BC-24-303**  
18.5 cm / 7 1/4"  
Cleft Palate Hooklets  
Ganchito para el paladar  
Crochet pour palais

long blade  
hoja larga  
lame longue



**Salyer  
BC-24-304**  
18 cm / 7"  
Cleft Palate Dissector  
Disecador para el paladar  
dissecteur pour palais

Nasal  
nasal  
nasale



**Salyer  
BC-24-305**  
18 cm / 7"  
Cleft Palate Dissector  
Disecador para el paladar  
dissecteur pour palais

Nasal  
nasal  
nasale



**Salyer  
BC-24-306**  
18 cm / 7"  
Cleft Palate Instruments  
Instrumentos el paladar  
Instruments pour palais



**Salyer  
BC-24-307**  
18 cm / 7"  
Cleft Palate Elevator  
Elevador para el paladar  
Elevateur pour palais



**Salyer  
BC-24-308**  
18 cm / 7"  
Cleft Palate Elevator  
Elevador para el paladar  
Elevateur pour palais



**Jaboma  
BC-24-309**  
17 cm / 6 3/4"  
Cleft Palate periosteal torium  
elevator  
Legra para paladar  
Raspatoir pour palais



**WELMED Instrument Company  
Defence Road, Near Wapda Grid Station  
Sialkot 51310, Pakistan.**

**Phone : +92 52 3554782, 3558704**

**Fax : +92 52 3550296**

**📞 Mobile : +92 333 8680640**

**Email : [welmedpk@gmail.com](mailto:welmedpk@gmail.com)**

**[info@welmedinst.com](mailto:info@welmedinst.com)**

**[wmm@brain.net.pk](mailto:wmm@brain.net.pk)**

**[welmed@cyber.net.pk](mailto:welmed@cyber.net.pk)**

**Website : [www.welmedinst.com](http://www.welmedinst.com)**