



Serving Humanity Since 1908

WELMED
INSTRUMENTS CO.

ENT Catalogue
Group 20, 21, 22, 23, 24 & 25



Manufacturers & Exporters of Quality Surgical Instruments

**Anaesthesia, Otology, Rhinology, Tonsillectomy,
Laryngo-Bronchoscopy, Oral Maxillo-Facial Surgery
and Carnio-Maxillo-Facial Surgery Instruments**



Nasal 22

WELMED Instruments Company
Defence Road
Near Wapda Grid Colony
Sialkot 51310, Pakistan.

Phone : +92 52 3554782, 3558704
Fax : +92 52 3550296
Cell : +92 333 8680640

Email : info@welmedinst.com
welmedpk@gmail.com
wmm@brain.net.pk
welmed@cyber.net.pk

Website : www.welmedinst.com

About Us

Quality begins at **WELMED** Instruments Company where master craftsmen forge and manufacture each instrument to its exact specifications and measurements. Instruments must undergo a series of quality control inspections in order to be worthy of **WELMED** name and warranty. We offer a wide selection of medical instruments including Surgical and Dental instruments.

We have acquired a unique and unmatched understanding of manufacturing through a large experience, working since 1908. Years of experience & state of the art manufacturing facilities helped us to keep our prices low. Our Surgical & Dental instruments are created by expert craftsmen, providing unfaltering quality you can rely on.

We have launched a fully interactive website where you can get online and track your orders 24 hours a day, 7 days in a week, and 365 days a year. Ask for our free e-catalogue on CD-Rom to save time and enjoy hassle free ordering.

We provide our customers with most reliable customer service as your satisfaction is our top priority. Our customers always enjoy our wonderful customer service and quality tools at the best price.

Lastly we invite you to have a work experience with **WELMED** Instruments Company and we will prove ourselves as one of the most valuable source you have.

You can find us at

WELMED Instruments Company
Defence Road, Near Wapda Grid Colony
Sialkot 51310, Pakistan.

Phone : +92 52 3554782, 3558704
Fax : +92 52 3550296
Cell : +92 333 8680640

Emails :
Info@welmedinst.com
welmedpk@gmail.com
wmm@brain.net.pk
welmed@cyber.net.pk

Website : www.welmedinst.com



History

WELMED Instruments Company was founded in 1995. Our Great Grandfather **Mian Muhammad Fazal Elahi** was the founder of M/s M.F. Elahi & Company (E.P.) Pvt. Ltd, established in 1908. WELMED is a sister concern of M.F.Elahi & Co. It is our pride to be a member of M.F. Elahi Family.

WELMED Instruments Company is located in the heart of beautiful city, Sialkot, Pakistan. We are manufacturers and exporters of quality Surgical, Dental instruments and Scissors of all sorts in various categories. We are closely attached with highly skilled surgeons and other technicians of the surgical industry to make the new instruments development possible.

WELMED is in a continues process of development and testing of new instruments for their precision and perfect functioning. We are also working at imported forging supply by foreign customers.

Certificates

Welmed Instruments Company has achieved the certificates for ISO-9001, ISO-13485, cGMP (FDA) and CE Marking.

Quality Control

All material use in the manufacturing of our instruments are tested from relevant laboratories. Our continuous quality control is our best warranty so that you built confidence in our products.

Deliveries

Deliveries are quick and in-time.

Mode Of Payment

Terms of Payment is ADVANCE or LETTER OF CREDIT (Irrevocable)

Quality Policy

WELMED Instruments Company aims to produce quality Surgical, Dental instruments and Scissors of all sorts at reasonable prices to become an exemplary manufacturer. Our total emphasize is to achieve customer's satisfaction by clearly understanding their requirements and following a quality management system which is a primary concern of all our work force. We do our best to produce instruments of finest quality.



Warranty

All WELMED Instruments are produced from finest stainless steel available to be free from any defect in material or workmanship. Any product that proves to be defective in material or workmanship will either be repaired or replaced without any charge. This warranty is void if the instrument is abused, altered, modified or is not used in the manner for which it is intended.

Nasal 22



WELMED
INSTRUMENTS CO.

Aiach	134	Rotating Ostrum	138
Asch	133	Rubin	116,125
Aufricht	129,132	Sheehan	126
Ballenger	119,123	Sidebiting Antrum	137
Ballenger-Hajek	121	Silver	127
Beckmann Angled Shaft	112	Stammberger	146
Beckmann Trapezoidal Fenestrated	111	Struycken	145
Beckmann	107,112	Takahashi	143
Brunings	114,120	TC-Rubin	116
Caplan	116	Thru Cutting	140,141
Cinelli	125	Tieck-Halle	106
Converse Alar Hooklet	131	Thudichum	107
Converse	118,130,131	Troltsch	117
Cottle Columella Forcep	134	Vienna Pattern	105
Cottle Osteotomes	124	Voltolini (Duplay)	107
Cottle Saddle Hook	132	Walter	125
Cottle	118,121,122,128,130,132,134	Watson-Williams	136,143
Cottle-Neivert	132	Weil	143
Cottle-Walsham	133	Weil-Blakesley	144,145
Cutting Forcep	140	Schmeden	146
Cutting Giraffe	139		
Cutting Pediatric	141		
Ferris-Smith-Kerrison	109		
Fomon Alar Hooklet	130		
Fomon	118,125,129,132		
Fraenkel	107		
Freer Mucosa Knife	119		
Freer Septum Gouge	123		
Freer	119,120,123,131		
Frontal Sinus	138		
Gallaher	128		
Giraffe Type	139		
Graig	113		
Gruenwald Nasal Forcep	136		
Grunwald (jansen)	117		
Hajek-Kofler	108		
Halle	120		
Hartmann	106,113,146		
Hartmann-Halle	106		
Joseph File	128		
Joseph Mucosa Hooklet	130		
Joseph Nasal Saws	127		
Joseph Osteotome	127		
Joseph	118,120,122,128,131		
Joseph-Masing	122		
Masing	122		
Mckenty	120,121		
Middleton-Jansen	115		
Nasal Cutting Cont	135		
Neivert	132		
Neivert-Anderson	126		
Ogura	134		
Ostrum Antrum Punch	137		
Parkes	127		
Pediatric Ostrum	137		
Pediatric Rotating	138		
Pennington	121		
Roger	122		

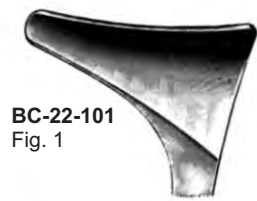

BC-22-101
Fig. 1



BC-22-102
Fig. 2

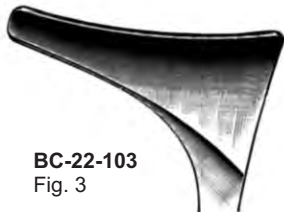

BC-22-103
Fig. 3



BC-22-101 Fig. 1
BC-22-102 Fig. 2
BC-22-103 Fig. 3
14 cm
Vienna pattern



BC-22-104
Fig. 1



BC-22-105
Fig. 2



BC-22-104 Fig. 1
BC-22-105 Fig. 2
13 cm
Vienna pattern

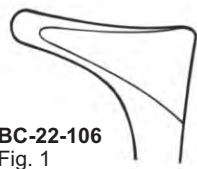

BC-22-106
Fig. 1

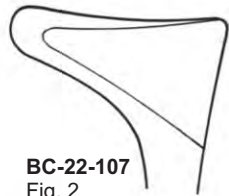

BC-22-107
Fig. 2

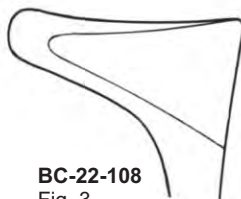

BC-22-108
Fig. 3



BC-22-106 Fig. 1
BC-22-107 Fig. 2
BC-22-108 Fig. 3
15 cm
Vienna pattern

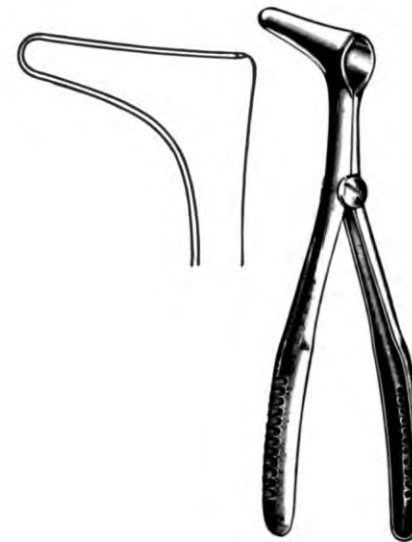

BC-22-109
14 cm

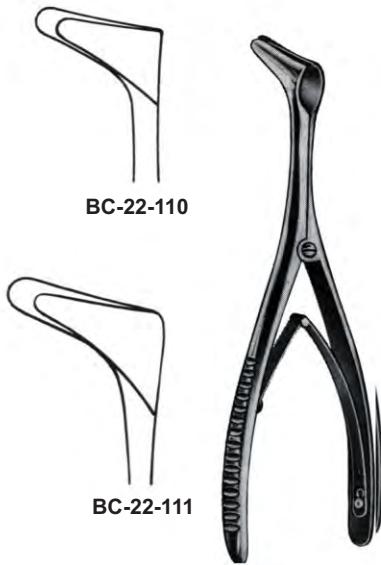

BC-22-110

BC-22-111

Tieck-Halle
BC-22-110 Fig. 1
BC-22-111 Fig. 2
13.5 cm

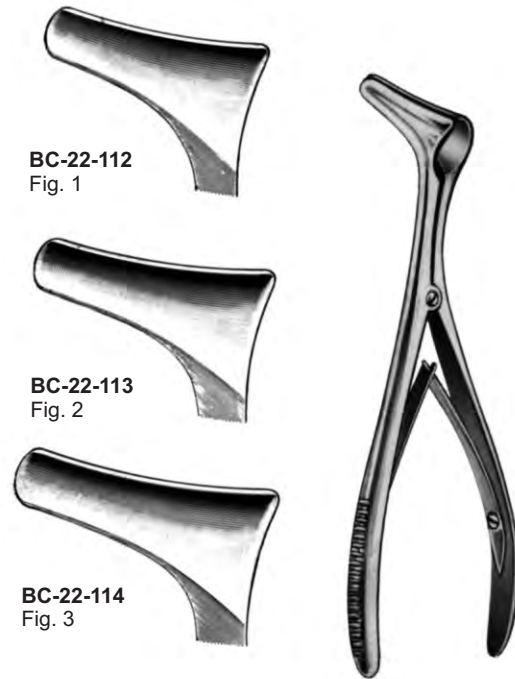

BC-22-112
Fig. 1

BC-22-113
Fig. 2

BC-22-114
Fig. 3

Aseptic joint
(dismantleable)

Hartmann
BC-22-112 Fig. 1
BC-22-113 Fig. 2
BC-22-114 Fig. 3
15 cm



Hartmann-Halle
BC-22-115 Fig. 1
BC-22-116 Fig. 2
BC-22-117 Fig. 3
15 cm

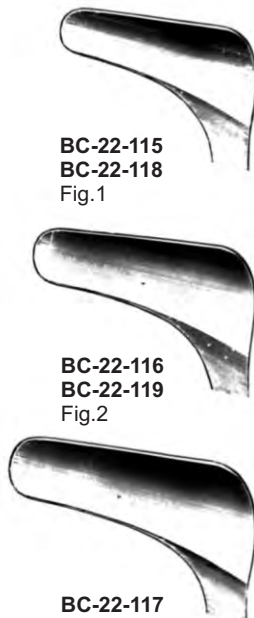

BC-22-115
BC-22-118
Fig.1

BC-22-116
BC-22-119
Fig.2

BC-22-117
BC-22-120
Fig.3



Hartmann-Halle
BC-22-118 Fig. 1
BC-22-119 Fig. 2
BC-22-120 Fig. 3
15 cm



Beckmenn
BC-22-121
13 cm
Fig.0



BC-22-122
Fig. 1



BC-22-123
Fig. 2



Bc-22-124
Fig. 3



Beckmenn
BC-22-122 Fig. 1
BC-22-123 Fig. 2
BC-22-124 Fig. 3
15 cm

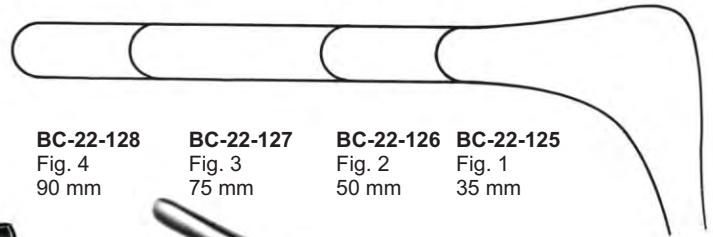

BC-22-128 Fig. 4
90 mm
BC-22-127 Fig. 3
75 mm
BC-22-126 Fig. 2
50 mm
BC-22-125 Fig. 1
35 mm



Killian
BC-22-125 Fig. 1
BC-22-126 Fig. 2
BC-22-127 Fig. 3
BC-22-128 Fig. 4
14 cm



BC-22-129
Fig. 1



BC-22-130
Fig. 2



BC-22-131
Fig. 3



Thudichum (Goldsmith)
6.5 cm



Fraenkel
BC-22-132
8 cm



Duplay (Voltolini)
BC-22-133 Fig. 1
BC-22-134 Fig. 2
BC-22-135 Fig. 3

4 x 4 mm

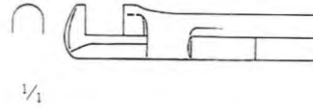

**Hajek
BC-22-136**
14 cm / 5 1/2"
up cutting

4 x 4 mm

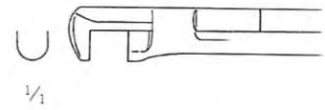

**Hajek
BC-22-137**
14 cm / 5 1/2"
down cutting

3.5 x 3.5 mm

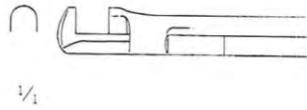

**Hajek-Kofler
BC-22-138**
14 cm / 5 1/2"
up cutting

3.5 x 3.5 mm

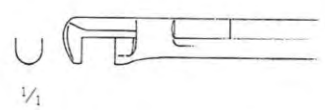

**Hajek-Kofler
BC-22-139**
14 cm / 5 1/2"
down cutting

140 mm





3 x 3 mm

3 x 3 mm

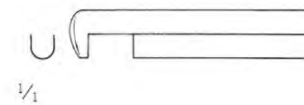
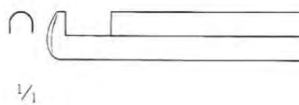

BC-22-140
18 cm / 7"
up cutting

BC-22-141
18 cm / 7"
down cutting

180 mm



Ferris-Smith-Kerrison

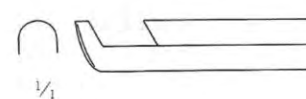
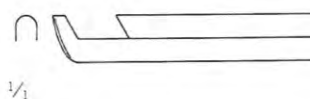

BC-22-142
18 cm / 7"
obliquely forward cutting
bite
3.0 mm

BC-22-143
18 cm / 7"
obliquely forward cutting
bite
5.0 mm

180 mm



Ferris-Smith-Kerrison

3 x 3 mm



BC-22-145
up cutting

4 x 4 mm



BC-22-146
up cutting

90 mm



Kerrison

5 x 5 mm



BC-22-147
up cutting

6 x 6 mm



BC-22-148
up cutting



Beckmenn
trapezoidal fenestrated



BC-22-149
22.5 cm / 8 3/4"
16 mm
Fig. 1



BC-22-150
22.5 cm / 8 3/4"
17 mm
Fig. 2



BC-22-151
22.5 cm / 8 3/4"
18 mm
Fig. 3



BC-22-152
22.5 cm / 8 3/4"
20 mm
Fig. 4



BC-22-153
22.5 cm / 8 3/4"
21 mm
Fig. 5



Beckmann



Beckmann
angled shaft



BC-22-154
22.5 cm / 8 3/4"
13 mm
Fig. 1



BC-22-155
22.5 cm / 8 3/4"
15 mm
Fig. 2



BC-22-156
22.5 cm / 8 3/4"
17 mm
Fig. 3

BC-22-160
22 cm / 8 3/4"
13 mm
Angled

BC-22-161
22 cm / 8 3/4"
15 mm
Angled

BC-22-162
22 cm / 8 3/4"
17 mm
Angled



BC-22-157
22.5 cm / 8 3/4"
19 mm
Fig. 4



BC-22-158
22.5 cm / 8 3/4"
21 mm
Fig. 5



BC-22-159
22.5 cm / 8 3/4"
23 mm
Fig. 6

BC-22-163
22 cm / 8 3/4"
19 mm
Angled

BC-22-164
22 cm / 8 3/4"
21 mm
Angled

BC-22-165
22 cm / 8 3/4"
23 mm
Angled



Hartmann
BC-22-166
15 cm / 6"



Hartmann
BC-22-167
18.5 cm / 7 1/4"



Killian
BC-22-168
16 cm / 6 1/4"



Knight
BC-22-169
17 cm / 6 3/4"



Graig
BC-22-170
16 cm / 6 1/4"



BC-22-171
16 cm / 6 1/4"
left curved



BC-22-172
16 cm / 6 1/4"
right curved



BC-22-173
18.5 cm / 7 1/4"
Fig. 1



BC-22-174
18.5 cm / 7 1/4"
Fig. 2

Luc

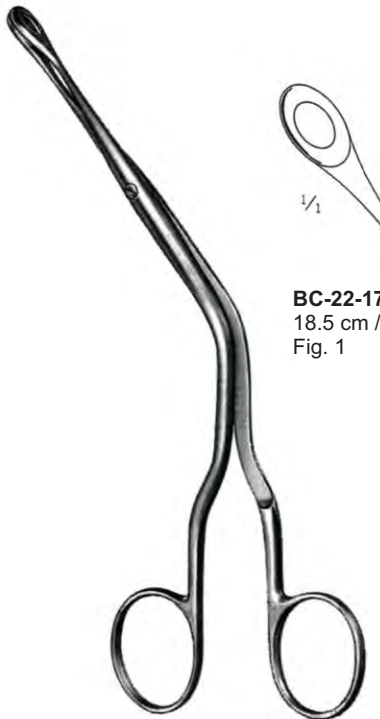

BC-22-175
18.5 cm / 7 1/4"
Fig. 1



BC-22-176
18.5 cm / 7 1/4"
Fig. 2

Luc

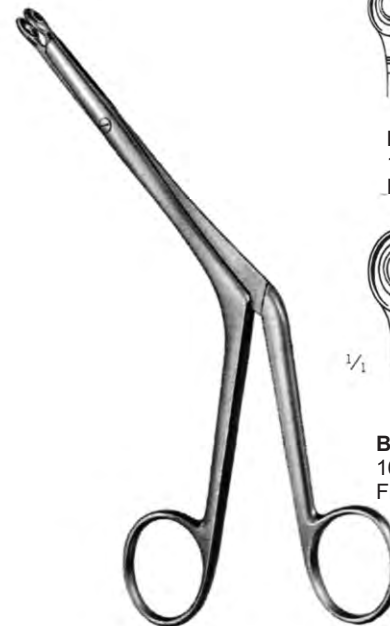

BC-22-177
16.5 cm / 6 1/2"
Fig. 1



BC-22-178
16.5 cm / 6 1/2"
Fig. 2



BC-22-179
16.5 cm / 6 1/2"
Fig. 3



BC-22-180
16.5 cm / 6 1/2"
Fig. 4

Brunings



Middleton-Jansen
BC-22-181
19 cm / 7 ½"



Middleton-Jansen
BC-22-182
19 cm / 7 ½"



Caplan
BC-22-183
20 cm / 8"
one toothed cutting edge



Rubin
BC-22-184
21 cm / 8 1/4"



TC-Rubin
BC-22-184A
21 cm / 8 1/2"

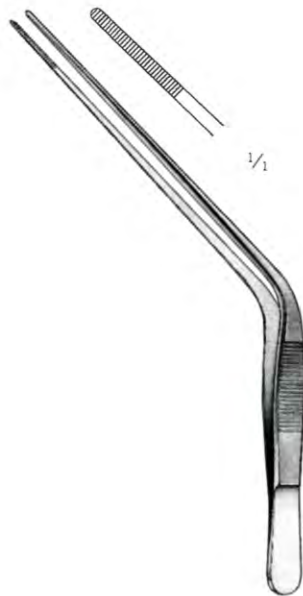

**Trotsch
BC-22-185**
14.5 cm / 5 3/4"



**Trotsch
BC-22-186**
18 cm / 7"



**Grunwald (Jansen)
BC-22-187**
21.5 cm / 8 1/2"



**Lubet-Barbon
BC-22-188**
18.5 cm / 7 1/4"
Nasal Tampon Forceps



Joseph

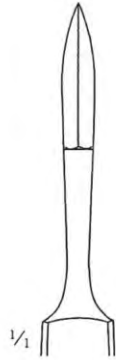

BC-22-189
15 cm / 6"
Fig. 1

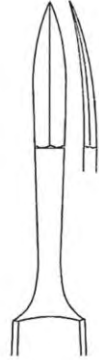

BC-22-190
15 cm / 6"
Fig. 2



Fomon

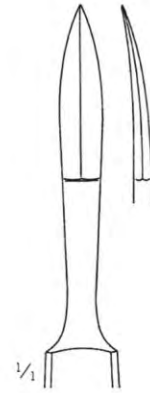

BC-22-191
16.5 cm / 6 1/2"



Converse



BC-22-192
16 cm / 6 1/4"



Joseph



BC-22-193
15 cm / 6"



Cottle



BC-22-194
14 cm / 5 1/2"



BC-22-195
16.5 cm / 6 1/2"

Freer
Mucosa Knife



BC-22-196
19 cm / 7 1/2"

Freer

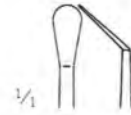

BC-22-197
19 cm / 7 1/2"

Freer



BC-22-198
21 cm / 8 1/4"
3.0 mm

Ballenger

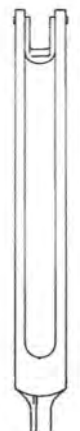

BC-22-199
21 cm / 8 1/4"
4.0 mm

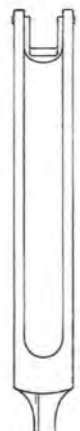

BC-22-200
21 cm / 8 1/4"
5.0 mm



BC-22-201
20 cm / 8"
3.0 mm

Ballenger



BC-22-202
20 cm / 8"
4.0 mm

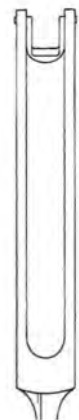

BC-22-203
20 cm / 8"
5.0 mm



BC-22-204
16.5 cm / 6 1/2"

Brunings
Septum Knife



BC-22-205
15 cm / 6"
4 mm

McKenty



BC-22-206
15 cm / 6"
5 mm



BC-22-207
16 cm / 6 1/4"
3.5 mm

Halle



BC-22-208
16 cm / 6 1/4"
4 mm

Jopseph



BC-22-209
19 cm / 7 1/2"
5 mm
sharp

Freer



BC-22-210
19 cm / 7 1/2"
6 mm
blunt

Freer



BC-22-211
18.5 cm / 7 1/4"
5 / 5 mm
sharp / blunt

Freer

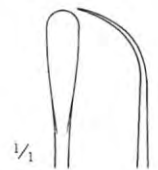

BC-22-212
20.5 cm / 8"
6 / 5 mm

Freer

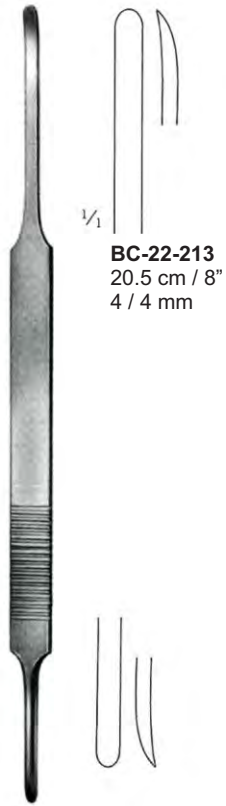

BC-22-213
20.5 cm / 8"
4 / 4 mm

McKenty



BC-22-214
19 cm / 7 1/2"
6 / 6 mm

Ballenger-Hajek

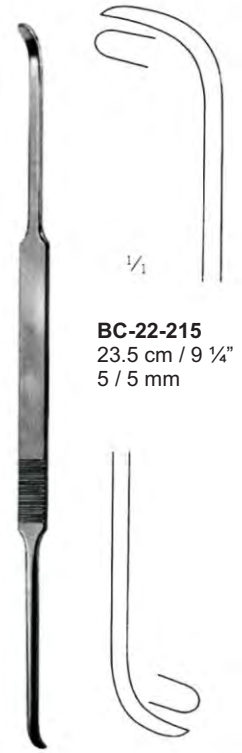

BC-22-215
23.5 cm / 9 1/4"
5 / 5 mm

Cottle

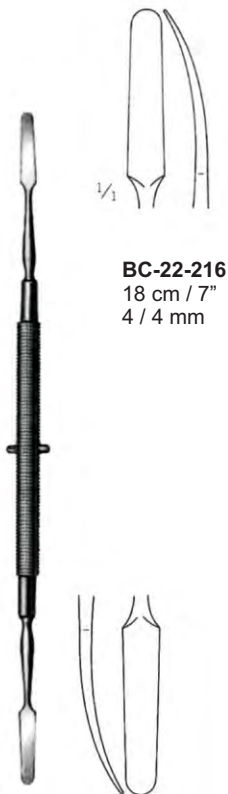

BC-22-216
18 cm / 7"
4 / 4 mm

Killian

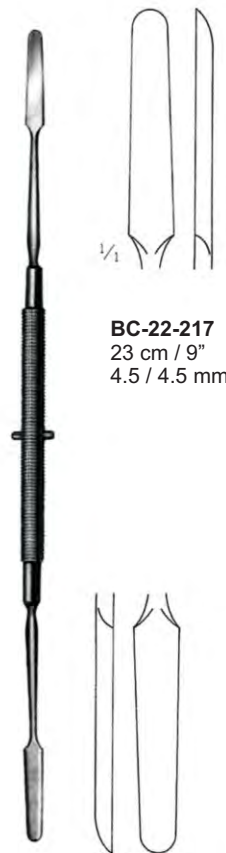

BC-22-217
23 cm / 9"
4.5 / 4.5 mm

Killian



BC-22-218
21.5 cm / 8 1/2"
4 / 4 mm

Pennington

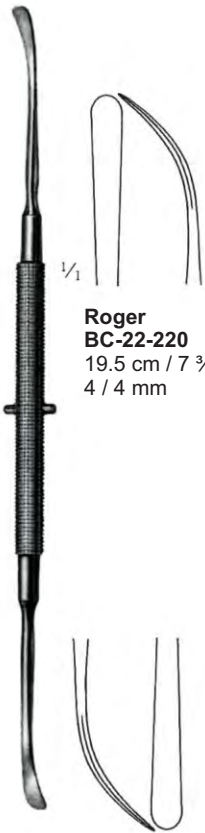

Roger
BC-22-220
19.5 cm / 7 3/4"
4 / 4 mm



Joseph-Masing
BC-22-221
21.5 cm / 8 1/2"
4 mm

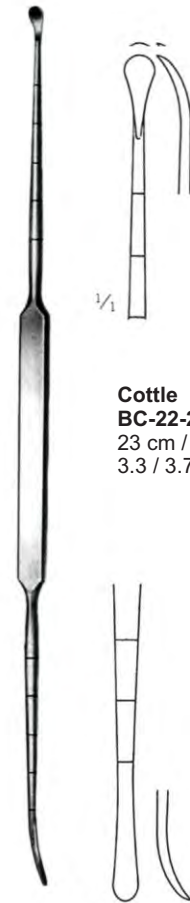

Cottle
BC-22-222
23 cm / 9"
3.3 / 3.7 mm

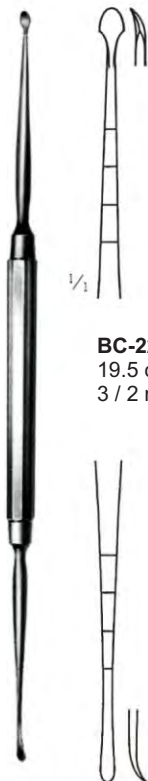

BC-22-223
19.5 cm / 7 3/4"
3 / 2 mm

Masing

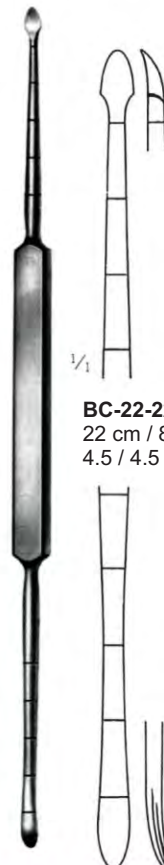

BC-22-224
22 cm / 8 3/4"
4.5 / 4.5 mm

Cottle



BC-22-225
18 cm / 7"
6.5 mm

Joseph

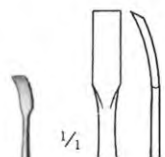

BC-22-226
16 cm / 6 1/4"
4 mm

Freer

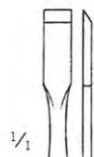

BC-22-227
16.5 cm / 6 1/2"
4 mm

Freer



BC-22-228
15 cm / 6"
6 mm

**Freer
Septum Gouge**



BC-22-229
15 cm / 6"
2 mm

Ballenger



BC-22-230
15 cm / 6"
4 mm



BC-22-231
15 cm / 6"
6 mm

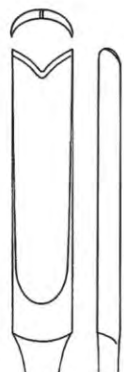

BC-22-232
15 cm / 6"
8 mm

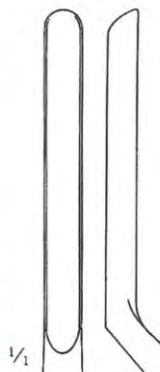

BC-22-233
16 cm / 6 1/4"
5 mm

Killian

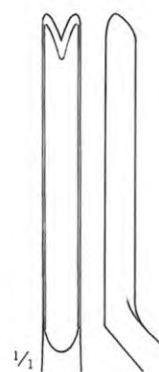

BC-22-234
16 cm / 6 1/4"
5 mm

Killian-Claus



BC-22-235
18.5 cm / 7 1/4"
4 mm



BC-22-236
18.5 cm / 7 1/4"
7 mm

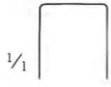

BC-22-237
18.5 cm / 7 1/4"
9 mm



BC-22-238
18.5 cm / 7 1/4"
12 mm

Cottle

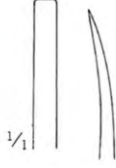

BC-22-239
18.5 cm / 7 1/4"
6 mm

Cottle



BC-22-240
18.5 cm / 7 1/4"
2 mm



BC-22-241
18.5 cm / 7 1/4"
4 mm



BC-22-242
18.5 cm / 7 1/4"
7 mm

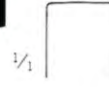

BC-22-243
18.5 cm / 7 1/4"
9 mm



BC-22-244
18.5 cm / 7 1/4"
12 mm

Cottle

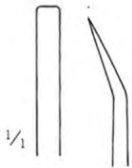

BC-22-245
18.5 cm / 7 1/4"
6 mm

Cottle

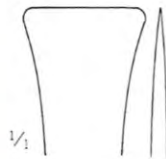

BC-22-246
18.5 cm / 7 1/4"
16 mm

Cottle

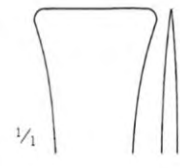

BC-22-247
18.5 cm / 7 1/4"
16 mm

Cottle

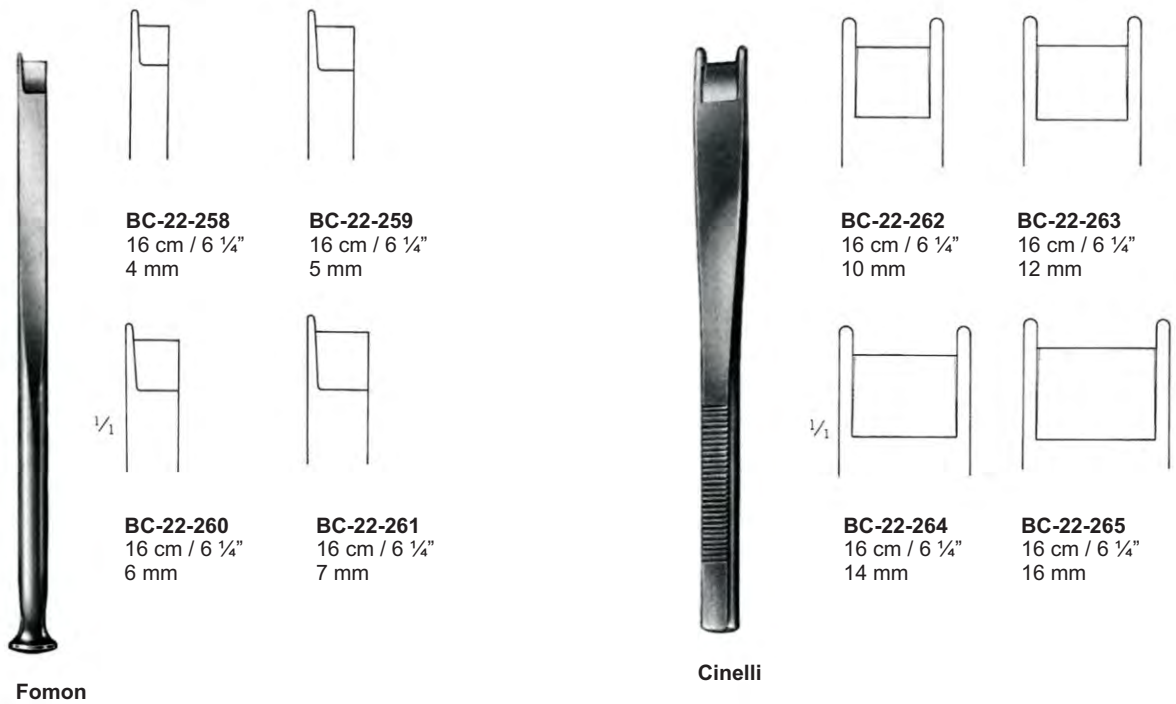
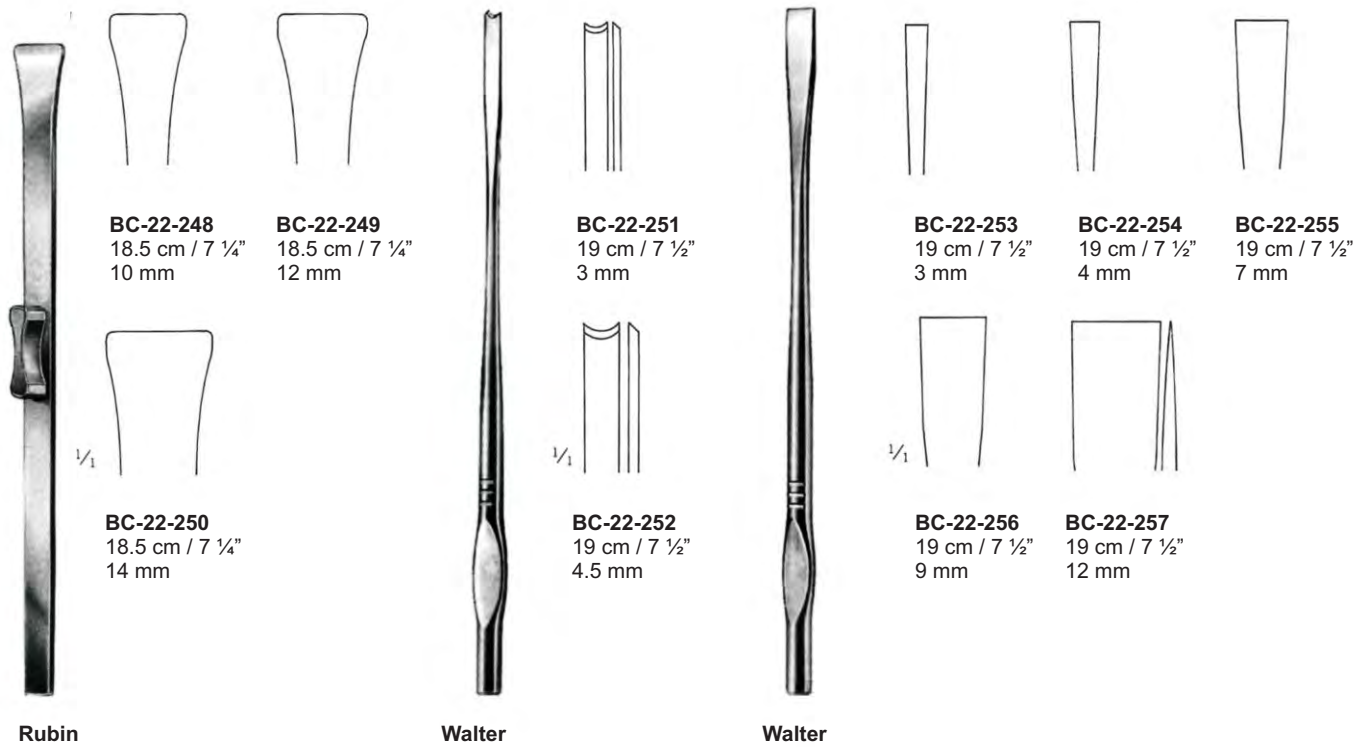



Neivert-Anderson

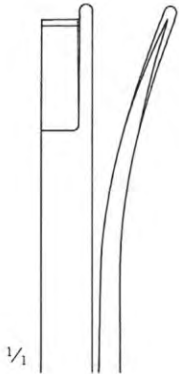

BC-22-266
20.5 cm / 8"
7 mm

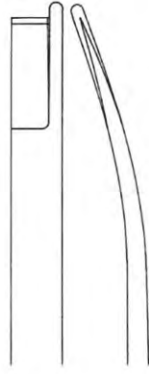

BC-22-267
20.5 cm / 8"
7 mm

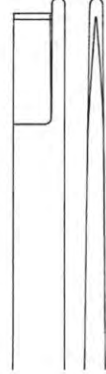

BC-22-268
20.5 cm / 8"
7 mm

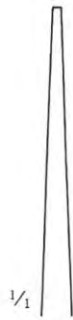

BC-22-269
15 cm / 6"
1 mm



BC-22-270
15 cm / 6"
2 mm



BC-22-271
15 cm / 6"
3 mm



BC-22-272
15 cm / 6"
4 mm



BC-22-273
15 cm / 6"
5 mm



Sheehan



BC-22-274
15 cm / 6"
6 mm



BC-22-275
15 cm / 6"
7 mm



BC-22-276
15 cm / 6"
8 mm



BC-22-277
15 cm / 6"
10 mm



BC-22-278
15 cm / 6"
12 mm

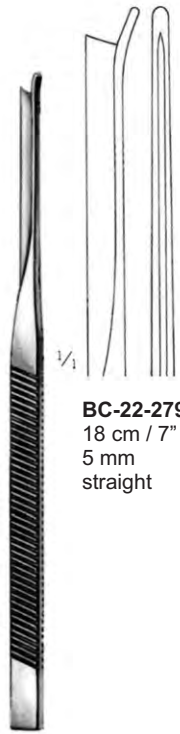

BC-22-279
18 cm / 7"
5 mm
straight

Silver

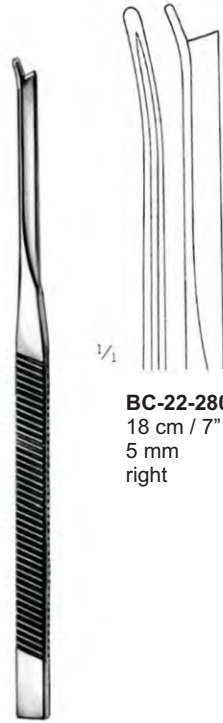

BC-22-280
18 cm / 7"
5 mm
right

Silver



BC-22-281
18 cm / 7"
5 mm
left

Silver

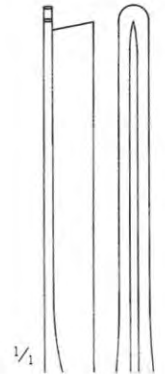

BC-22-282
16 cm / 6 1/4"

Parkes



BC-22-283
17 cm / 6 3/4"
angled to left

BC-22-284
17 cm / 6 3/4"
angled to right

Joseph



Joseph
working length 40 mm

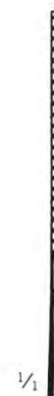

BC-22-285
19 cm / 7 1/2"

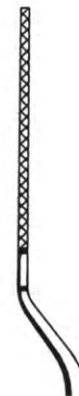

BC-22-286
19 cm / 7 1/2"

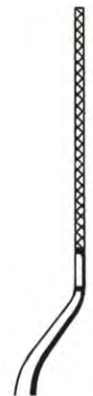

BC-22-287
19 cm / 7 1/2"

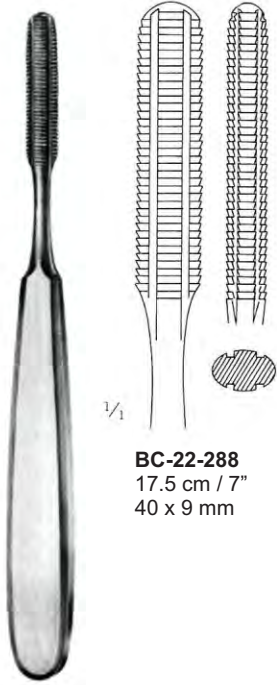

BC-22-288
17.5 cm / 7"
40 x 9 mm

Maltz

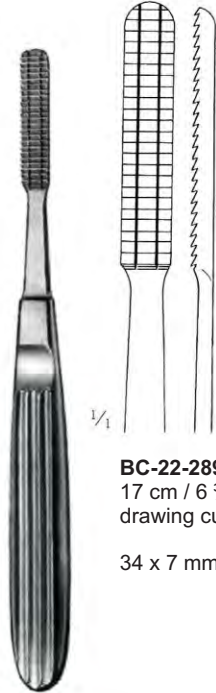

BC-22-289
17 cm / 6 3/4"
drawing cut
34 x 7 mm

Maltz

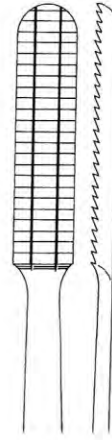

BC-22-290
17 cm / 6 3/4"
pushing cut
34 x 7 mm

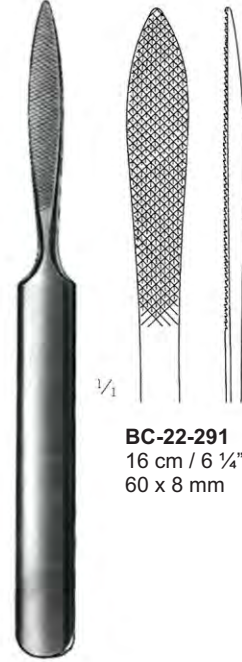

BC-22-291
16 cm / 6 1/4"
60 x 8 mm

Joseph

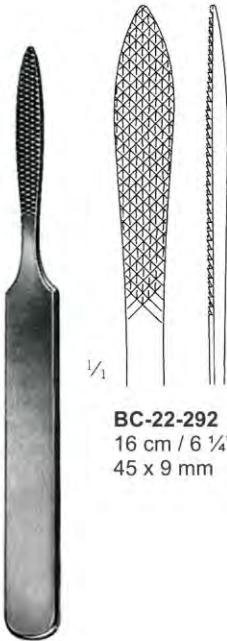

BC-22-292
16 cm / 6 1/4"
45 x 9 mm

Joseph



Gallaher



BC-22-293
17 cm / 6 3/4"
45 x 6 mm



BC-22-294
17 cm / 6 3/4"
45 x 6 mm



BC-22-295
17 cm / 6 3/4"
45 x 6 mm

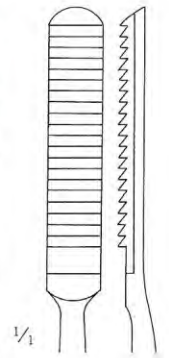

BC-22-296
20.5 cm / 8"
30 x 8 mm

Cottle



Aufricht

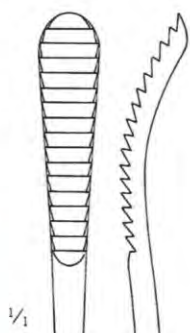

BC-22-297
21 cm / 8 1/4"
Pushing cut
32 x 9 mm

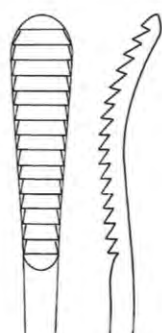

BC-22-298
21 cm / 8 1/4"
drawing cut
32 x 9 mm



Lewis

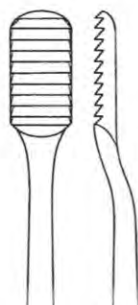

BC-22-299
19 cm / 7 1/2"
drawing cut
15 x 8 mm

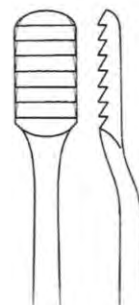

BC-22-300
19 cm / 7 1/2"
drawing cut
15 x 8 mm



Fomon

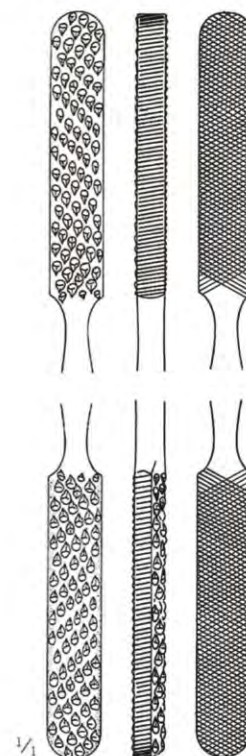

BC-22-301
20.5 cm / 8"
30 x 8 mm



BC-22-302
15.5 cm / 6"
sharp

Joseph
Mucosa hooklet



BC-22-303
17 cm / 6 3/4"
sharp

Cottle



BC-22-304
14.5 cm / 5 3/4"
sharp

Cottle



BC-22-305
14.5 cm / 5 3/4"
sharp



BC-22-306
14.5 cm / 5 3/4"
sharp



BC-22-307
23 cm / 9"
button end

Lange
Alar Hooklet



BC-22-308
9 cm / 3 1/2"
18 x 9.5 mm

BC-22-310
9 cm / 3 1/2"
28 x 12.5 mm

Converse

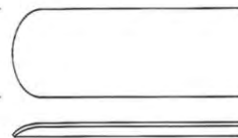

BC-22-309
9 cm / 3 1/2"
41 x 13.5 mm

BC-22-311
9 cm / 3 1/2"
53 x 13.5 mm



BC-22-312
17 cm / 6 3/4"



Fomon
Alar Hooklet

Button end



1/1

BC-22-313
19 cm / 7 1/2"
blade

40 x 12 mm

Aufricht



BC-22-314
8 cm / 3 1/4"
sharp

Kilner
Alar Hooklet



1/1

BC-22-315
10.5 cm / 4"
blade

44 x 11 mm

Converse



1/1

BC-22-316
11.5 cm / 4 1/2"
sharp



Converse
Alar Hooklet



1/1

BC-22-317
15 cm / 6"
sharp



Freer



1/1

BC-22-318
16.5 cm / 6 1/2"
2 mm



BC-22-319
16.5 cm / 6 1/2"
5 mm



BC-22-320
16.5 cm / 6 1/2"
7 mm



BC-22-321
16.5 cm / 6 1/2"
10 mm

Joseph

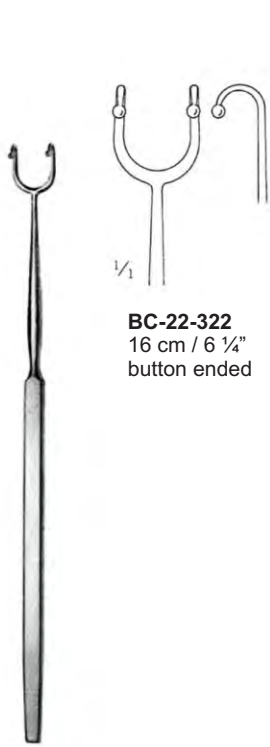

BC-22-322
16 cm / 6 1/4"
button ended

Fomon

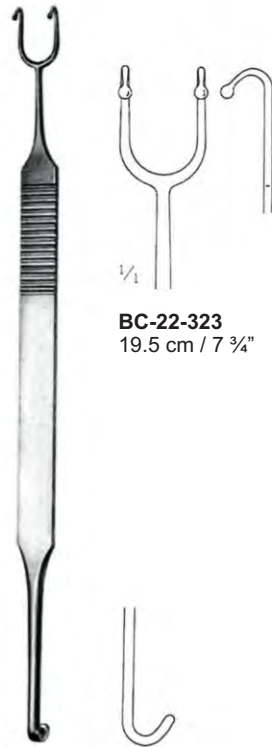

BC-22-323
19.5 cm / 7 3/4"

Cottle-Neivert



BC-22-324
14.5 cm / 5 3/4"
sharp

Cottle



BC-22-325
14.5 cm / 5 3/4"
blunt / sharp



BC-22-326
14.5 cm / 5 3/4"
sharp / blunt



BC-22-327
14 cm / 5 1/2"

Cottle



BC-22-328
17 cm / 6 3/4"

Neivert



BC-22-329
14 cm / 5 1/2"

Cottle
Saddle Hook



BC-22-330
16 cm / 6 1/4"

Cottle

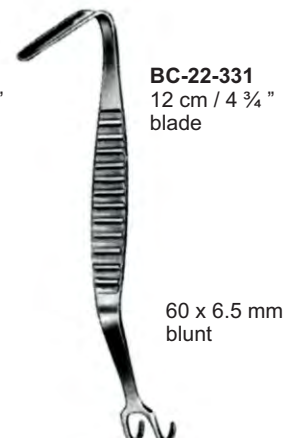

BC-22-331
12 cm / 4 3/4"
blade

Aufricht

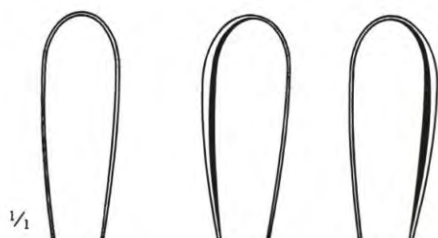

BC-22-333
23 cm / 9"
straight

BC-22-334
23 cm / 9"
left

BC-22-335
23 cm / 9"
right

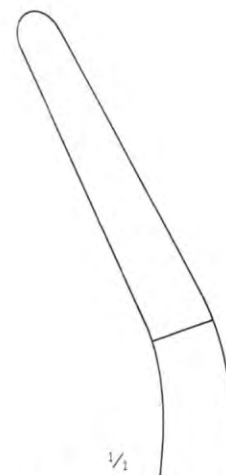

BC-22-336
22.5 cm / 8 3/4"



BC-22-332
21 cm / 8 1/4"

Kressner



Cottla-Walsham



Asch



BC-22-337
15.5 cm / 6"
5 mm wide

Aiach
Columella Suturing Forceps

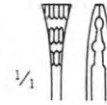

BC-22-338
11 cm / 4 1/4"
4 mm wide



Ogura

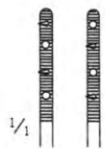

BC-22-339
14 cm / 5 1/2"
1.7 mm wide
with teeth

Cottle

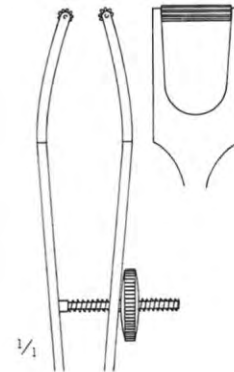

BC-22-340
11 cm / 4 1/4"
12 mm wide



Cottle
Columella Forceps



Punch

BC-22-341
Curved right
BC-22-342
Curved left



Scissors

BC-22-343
straight

BC-22-244
Scissors
curved down

BC-22-345
Scissors
Curved right

BC-22-346
scissors
Curved left





Gruenwald Nasal Forceps

BC-22-347
No. 1
2.5 mm x 9 mm thru-cutting jaws
Length of shaft 100 mm
Overall length 210 mm, 7.1 inches



Gruenwald Nasal Forceps

BC-22-348
No. 2
3 mm x 10 mm thru-cutting jaws
Length of shaft 100 mm
Overall length 180 mm, 7.1 inches



Gruenwald Nasal Forceps

BC-22-349
No. 3
3.5 mm x 11 mm thru-cutting jaws
Length of shaft 100 mm
Overall length 180 mm, 7.1 inches



Gruenwald Nasal Forceps

BC-22-350
Straight
3.5 mm x 10 mm thru-cutting jaws
Length of shaft 100 mm
Overall length 180 mm, 7.1 inches



Watson-Williams Nasal Forceps

BC-22-351
3 mm x 5 mm thru-cutting jaws with basket upturned
Length of shaft 125 mm
Overall length 205 mm, 8.1 inches



Weil Nasal Forceps

BC-22-352
5 mm x 8 mm cups
Length of shaft 100 mm
Overall length 182 mm, 7.2 inches



Weil Nasal Forceps

BC-22-353
5 mm x 8 mm cups
Length of shaft 100 mm
Overall length 182 mm, 7.1 inches



Wilde Nasal Forceps

BC-22-354
5 mm x 10 mm cups, fenestrated
Length of shaft 100 mm
Overall length 182 mm, 7.1 inches

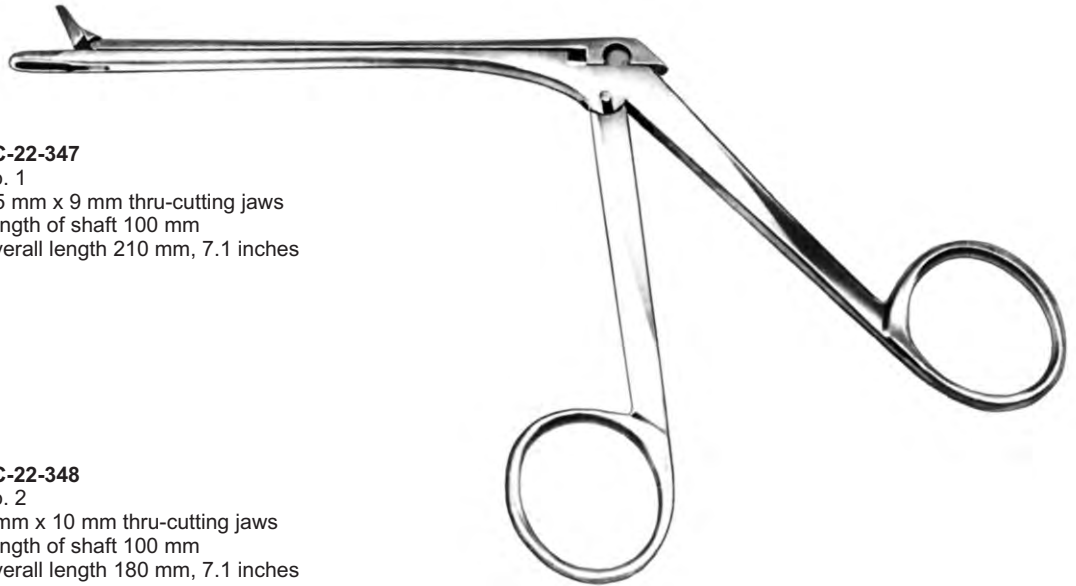



BC-22-355
 Straight, backward cutting left side
 3 mm x 7 mm bite
 Length of shaft 100 mm
 Overall length 180 mm, 7.1 inches

**Ostrum Antrum
 Punch Forceps**



**Ostrum Antrum
 Punch Forceps**



BC-22-356
 Straight, backward cutting right side
 3 mm x 7 mm bite
 Length of shaft 100 mm
 Overall length 180 mm, 7.1 inches



BC-22-357
 Left side cutting

**Sidebiting Antrum
 Punch Forceps**



BC-22-358
 Right side cutting

**Sidebiting Antrum
 Punch Forceps**



BC-22-359
 Straight, backward cutting
 1.5 mm x 4 mm bite
 Length of shaft 115 mm
 Overall length 160 mm, 6.3 inches

**Pediatric Ostrum
 Antrum Punch
 Forceps**



BC-22-360
 Straight, right side cutting
 1.5 mm x 4 mm bite
 Length of shaft 115 mm
 Overall length 160 mm, 6.3 inches

**Pediatric Ostrum
 Antrum Punch
 Forceps**



**Pediatric Ostrum
 Antrum Punch
 Forceps**

BC-22-361
 Straight, left side cutting
 1.5 mm x 4 mm bite
 Length of shaft 115 mm
 Overall length 160 mm, 6.3 inches



**Rotating ostrum
Antrum punch
Forceps**

BC-22-362
Rotating 360°

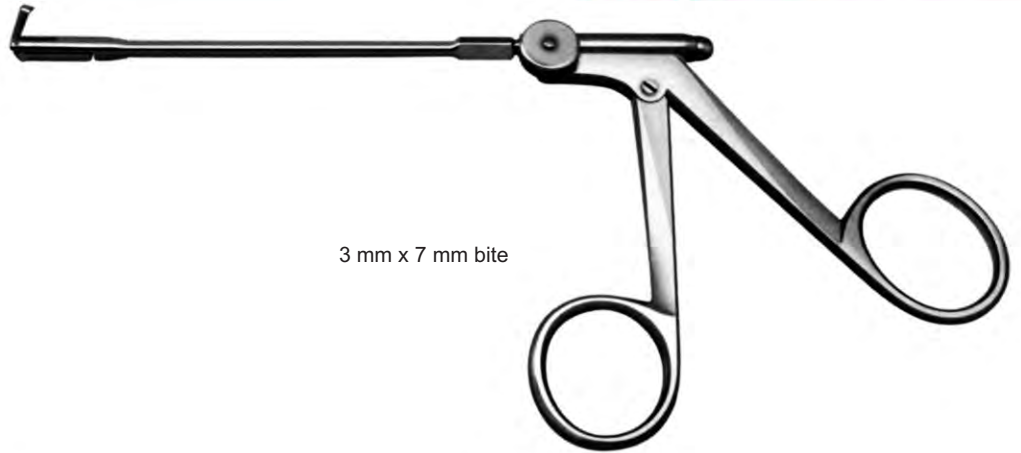

3 mm x 7 mm bite



**Pediatric Rotating ostrum
Antrum punch
Forceps**

BC-22-363
Rotating 360°



1.5 mm x 4 mm bite

Nasal and Sinus Cutting



**Front sinus
Forceps**

BC-22-364
450° vertical cutting
2 mm cups
Length of shaft 140 mm
Overall length 225 mm, 8.9 inches



**Front sinus
Forceps**

BC-22-367
90° horizontal cutting
2 mm cups
Length of shaft 140 mm
Overall length 225 mm, 8.9 inches



**Front sinus
Forceps**

BC-22-365
450° horizontal cutting
2 mm cups
Length of shaft 140 mm
Overall length 225 mm, 8.9 inches



**Front sinus
Forceps**

BC-22-368
45° vertical cutting
3 mm cups
Length of shaft 140 mm
Overall length 225 mm, 8.9 inches



**Front sinus
Forceps**

BC-22-366
90° vertical cutting
2 mm cups
Length of shaft 140 mm
Overall length 225 mm, 8.9 inches



**Front sinus
Forceps**

BC-22-369
90° horizontal cutting
3 mm cups
Length of shaft 140 mm
Overall length 225 mm, 8.9 inches





BC-22-370
 70° vertical cutting, double action
 3 mm cups
 length of shaft 130 mm
 Overall length 210 mm, 8.3 inches

**Giraffe Type
 Sinus Forceps**



BC-22-371
 70° horizontal cutting, double action
 4 mm cups
 length of shaft 130 mm
 Overall length 210 mm, 8.3 inches

**Giraffe Type
 Sinus Forceps**



BC-22-372
 100° horizontal cutting
 4 mm cups
 length of shaft 130 mm
 Overall length 210 mm, 8.3 inches

**Giraffe Type
 Sinus Forceps**

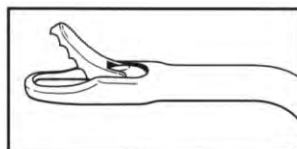
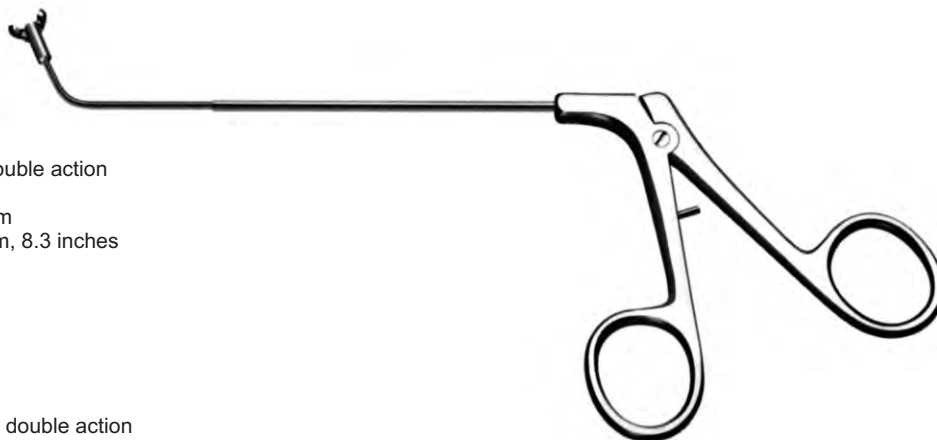

BC-22-373
 70° horizontal cutting
 1.6 mm x 80 mm bite

**Cutting Giraffe
 Forceps**

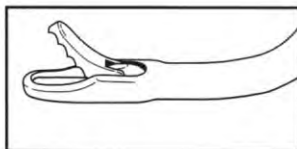

BC-22-374
 70° vertical cutting
 1.6 mm x 80 mm bite

**Cutting Giraffe
 Forceps**



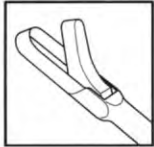

BC-22-375
70° vertical cutting
3 mm x 6 mm bite
Working length 120 mm, 4.7 inches

**Thru Cutting
Giraffe Forceps**



BC-22-376
No.1
straight
3.5 mm x 10 mm bite
Working length 120 mm, 4.7 inches

**Thru Cutting
Giraffe Forceps**



BC-22-377
No.1
45° angled up
2.5 mm x 10.5 mm jaw
Working length 220 mm, 8.9 inches

Cutting Forceps



BC-22-379
No.1
straight
2.5 mm x 10.5 mm jaw
Working length 220 mm, 8.9 inches

Cutting Forceps



BC-22-378
Cutting Forceps
No.0
straight
2.3 mm x 10 mm jaw
Working length 220 mm, 8.9 inches

BC-22-380
Cutting Forceps
No.0
45° angled up
2.3 mm x 10 mm jaw
Working length 220 mm, 8.9 inches



BC-22-381
Straight
3 mm x 10 mm bite
Working length 120 mm, 4.7 inches

TC
Thru Cutting
Pediatric Forceps



BC-22-382
45° angled up
2 mm x 6 mm bite
Working length 220 mm, 8.9 inches

Cutting
Pediatric Forceps



BC-22-383
Straight
2 mm x 6 mm bite
Working length 220 mm, 8.9 inches

Cutting
Pediatric Forceps



BC-22-384
26 cm / 10 1/4"
shaft
3 mm ø

Krause



BC-22-385
26 cm / 10 1/4"
shaft
3 mm ø

Krause-Voss



BC-22-400
19 cm / 7 1/2"
straight

BC-22-401
19 cm / 7 1/2"
bent upward

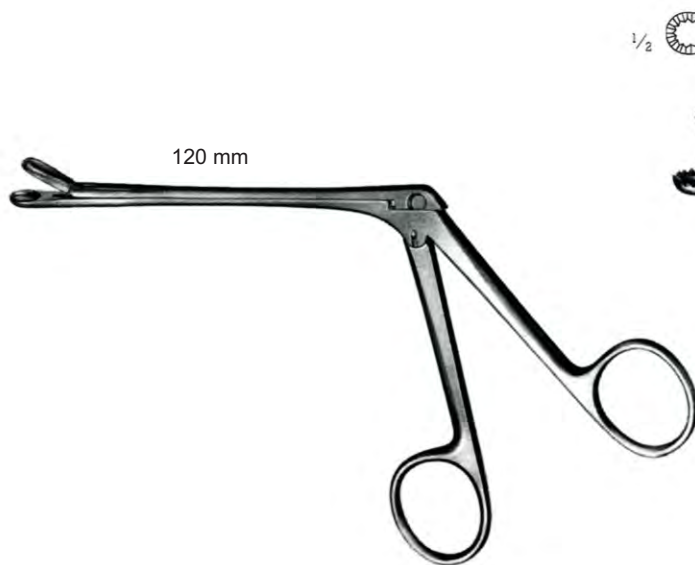

Watson-Williams
BC-22-402
19 cm / 7 1/2"

BC-22-403
19 cm / 7 1/2"

Weil
BC-22-404
12 cm / 4 3/4"
with neck



BC-22-405
12 cm / 4 3/4"
Fig. 1
jaw width
3.0 mm



BC-22-406
12 cm / 4 3/4"
Fig. 2
jaw width
3.5 mm



BC-22-407
12 cm / 4 3/4"
Fig. 3
jaw width
4.5 mm



BC-22-408
12 cm / 4 3/4"
Fig. 4
jaw width
5.0 mm



BC-22-409
12 cm / 4 3/4"
Fig. 5
jaw width
5.5 mm

120 mm



Weil-Blakesley

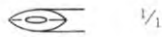

BC-22-410
12 cm / 4 3/4"
Fig. 1
jaw width
3.0 mm



BC-22-411
12 cm / 4 3/4"
Fig. 2
jaw width
3.5 mm



BC-22-412
12 cm / 4 3/4"
Fig. 3
jaw width
4.5 mm



BC-22-413
12 cm / 4 3/4"
Fig. 4
jaw width
5.0 mm

120 mm



Weil-Blakesley



90°



BC-22-414
12 cm / 4 3/4"
Fig. 1
jaw width
3.0 mm



BC-22-415
12 cm / 4 3/4"
Fig. 2
jaw width
3.5 mm



BC-22-416
12 cm / 4 3/4"
Fig. 3
jaw width
4.5 mm



BC-22-417
12 cm / 4 3/4"
Fig. 4
jaw width
5.0 mm



120 mm

Weil-Blakesley



120 mm



Struycken



BC-22-418
19 cm / 4 3/4"
Fig. 1
0.9 mm



BC-22-419
19 cm / 4 3/4"
Fig. 2
1.2 mm

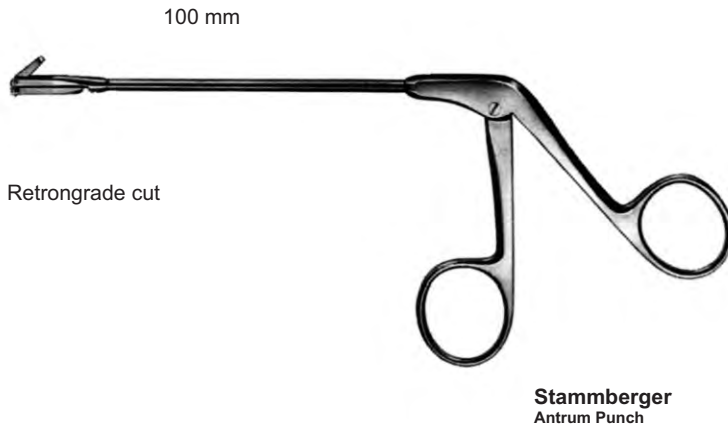

BC-22-420
2 mm
up cutting



BC-22-421
2 mm
right cutting



BC-22-422
2 mm
left cutting



BC-22-423
19 cm / 7 1/2"
5 mm ø



BC-22-424
19 cm / 7 1/2"
7 mm ø



BC-22-425
19 cm / 7 1/2"
9 mm ø



BC-22-426
19 cm / 7 1/2"
11 mm ø



Schmeden
BC-22-427
19 cm / 7 1/2"
jaw width

8.0 mm ø



**WELMED Instrument Company
Defence Road, Near Wapda Grid Station
Sialkot 51310, Pakistan.**

Phone : +92 52 3554782, 3558704

Fax : +92 52 3550296

☎ Mobile : +92 333 8680640

Email : welmedpk@gmail.com

info@welmedinst.com

wmm@brain.net.pk

welmed@cyber.net.pk

Website : www.welmedinst.com