



Tooth Tweezers



serrated



1/2

PERRY
DI-04-101
130 mm, 5 1/8"

smooth



1/2

DI-04-102
130 mm, 5 1/8"

smooth



1/2

FLAGG
DI-04-103
150 mm, 6"

smooth

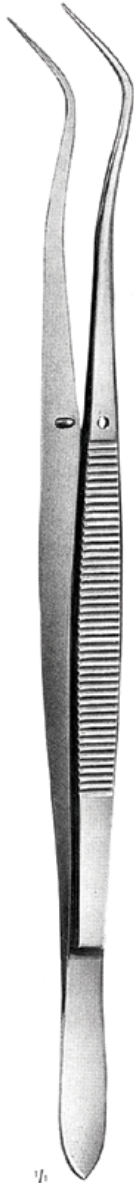

1/2

MERIAM
DI-04-104
150 mm, 6"

serrated



1/2

DI-04-105
160 mm, 6 1/4"

serrated

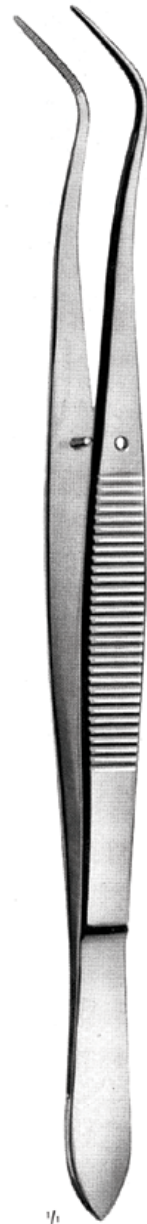

1/2

MERIAM
DI-04-106
160 mm, 6 1/4"

serrated



1/2

MERIAM
DI-04-107
160 mm, 6 1/4"



Tooth Tweezers



LONDON-COLLEGE
DI-04-108
smooth
150 mm, 6"



LONDON-COLLEGE
DI-04-109
serrated
150 mm, 6"

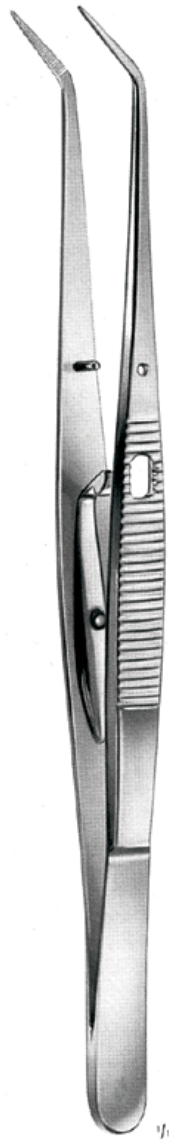

LONDON-COLLEGE
DI-04-110
serrated/with lock
150 mm, 6"



LONDON-COLLEGE
DI-04-111
serrated
150 mm, 6"



LONDON-COLLEGE
DI-04-112
serrated
150 mm, 6"



LONDON-COLLEGE
DI-04-113
serrated
150 mm, 6"



Tooth Tweezers



DI-04-114
150 mm, 6"



DI-04-115
150 mm, 6"
mit Schloß
with lock



DI-04-116
Suture forceps, angulated, for holding tissue and membranes. The slit in the working tip serves for an optimal positioning of the needle.
150 mm, 6"



Dressing Forceps



$\frac{1}{2}$

standard pattern



$\frac{1}{4}$

DI-04-117
14,5 cm / 5 $\frac{3}{4}$ "



DI-04-118
16 cm / 6 $\frac{1}{4}$ "



DI-04-119
18 cm / 7"



$\frac{1}{2}$

slender pattern



$\frac{1}{4}$

DI-04-120
14,5 cm / 5 $\frac{3}{4}$ "



DI-04-121
16 cm / 6 $\frac{1}{4}$ "



DI-04-122
18 cm / 7"



$\frac{1}{2}$

Mini-Adson



$\frac{1}{4}$

DI-04-123
12 cm / 4 $\frac{3}{4}$ "



$\frac{1}{2}$

Adson



$\frac{1}{4}$

DI-04-124
12 cm / 4 $\frac{3}{4}$ "



DI-04-125
15 cm / 6"



Dissecting Forceps

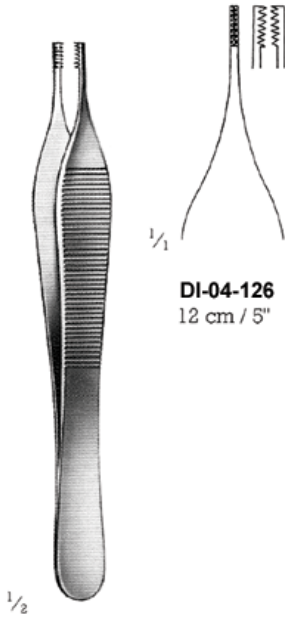

DI-04-126
12 cm / 5"

Adson-Brown

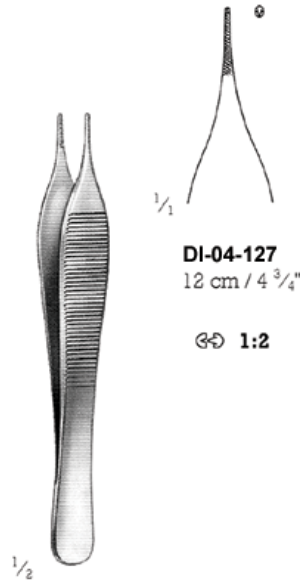

DI-04-127
12 cm / 4 3/4"

Mini-Adson

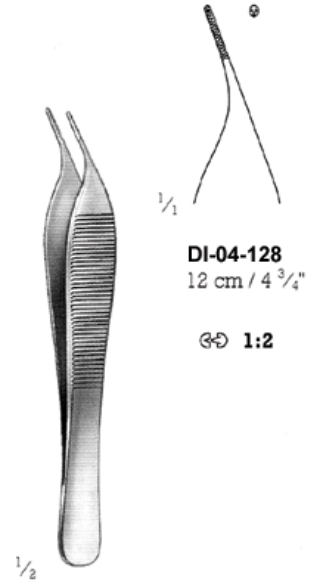

DI-04-128
12 cm / 4 3/4"

Mini-Adson

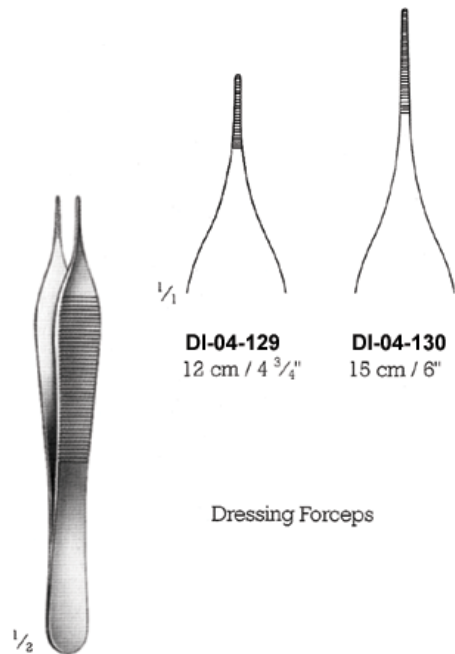

DI-04-129
12 cm / 4 3/4"

Dressing Forceps

Mikro-Adson



DI-04-130
15 cm / 6"

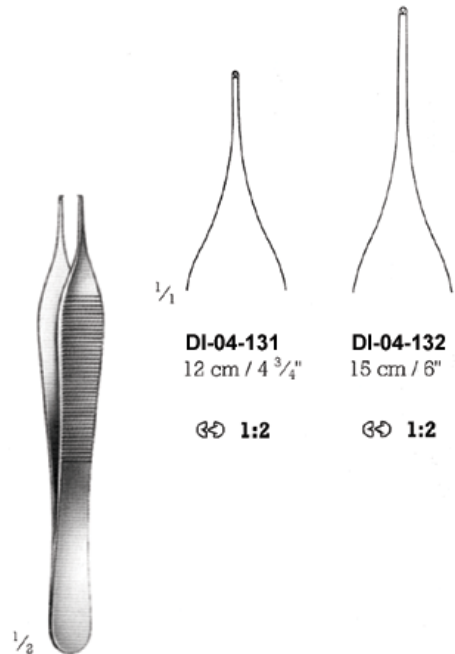

DI-04-131
12 cm / 4 3/4"

Mikro-Adson



DI-04-132
15 cm / 6"



Dressing Forceps



$\frac{1}{2}$
Semken



$\frac{1}{4}$
DI-04-133
12,5 cm / 5"



$\frac{1}{4}$
DI-04-134
15 cm / 6"



$\frac{1}{2}$
Taylor



$\frac{1}{4}$
DI-04-135
17 cm / 6 $\frac{3}{4}$ "



$\frac{1}{2}$

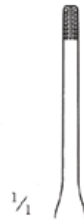

$\frac{1}{4}$
DI-04-136
17,5 cm / 6 $\frac{3}{4}$ "



Dissecting Forceps



DI-04-137
14,5 cm / 5 3/4"

↻ 1:2



DI-04-138
16 cm / 6 1/4"

↻ 1:2



DI-04-139
18 cm / 7"

↻ 1:2

slender pattern



DI-04-140
14,5 cm / 5 3/4"

↻ 1:2



DI-04-141
16 cm / 6 1/4"

↻ 1:2

slender pattern



DI-04-142
15 cm / 6"

↻ 1:2

Adson



DI-04-143
15,5 cm / 6"

↻ 1:2

Gillies



DI-04-144
12,5 cm / 5"

↻ 1:2

Semken



DI-04-145
15 cm / 6"

↻ 1:2



Dental Forceps

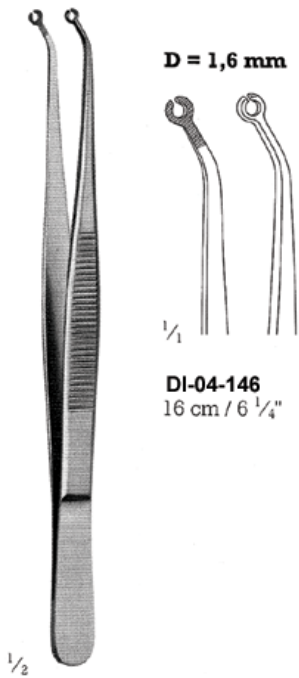

D = 1,6 mm

DI-04-146
16 cm / 6 1/4"

1/2

Martin
Suture and membrane forceps

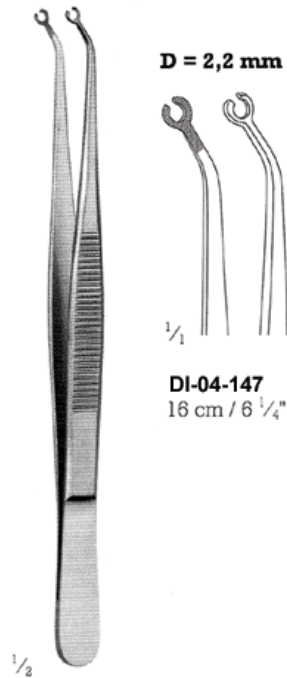

D = 2,2 mm

DI-04-147
16 cm / 6 1/4"

1/2

Martin
Suture and membrane forceps

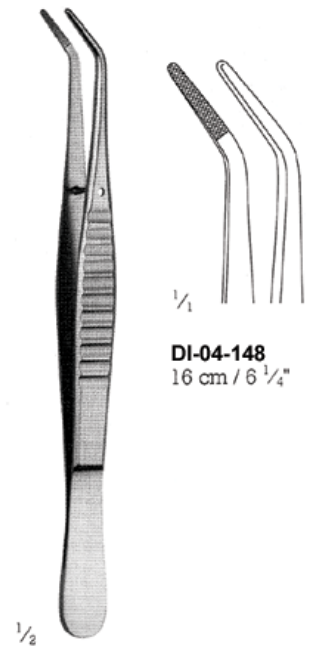

DI-04-148
16 cm / 6 1/4"

1/2

Martin



Dissecting Forceps, Atraumatic Dressing Forceps



DI-04-149
15,5 cm / 6"

⊗ 1:2
mini profile

1/2

Gillies



DI-04-150
12 cm / 4 3/4"

⊗ 1:2
mini profile

1/2

Adson



DI-04-151
15 cm / 6"

⊗ 1:2



DI-04-152
16 cm / 6 1/4"
micro profile

1,6 mm

1/2

DeBakey



DI-04-153
18 cm / 7"

1/2

JABOMA



DI-04-154
18 cm / 7"

⊗ 1:2

1/2

JABOMA



DI-04-155
18 cm / 7"

⊗ 1:2

1/2

JABOMA



Tooth Tweezers



Special tooth tweezers
LONDON-COLLEGE, mod.

Particularly strong, distortion-free design, serrated.

DUROGRIP-Tooth forceps with tungsten carbide insert for secure grasping of matrices and interdental wedges.



DI-04-156
150 mm, 6"
smooth

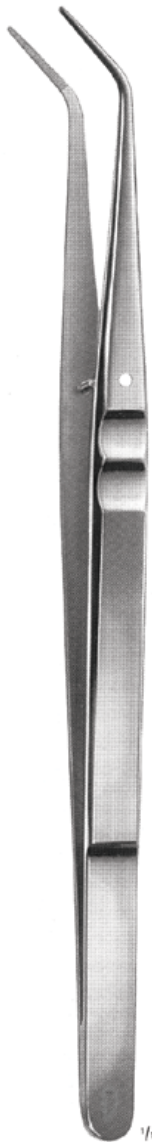

DI-04-157
150 mm, 6"
serrated



LONDON-COLLEGE, mod.

DI-04-158
150 mm, 6"



DI-04-159
150 mm, 6"





Tooth Tweezers



1x2



Taylor
DI-04-160
18 cm

1x2



Cushing
DI-04-161
18 cm

1x2



Micro-Cushing
DI-04-162
18 cm, very fine



Fox
DI-04-163
Gum seizing forceps, 15,5 cm

Fox
DI-04-164
with lock

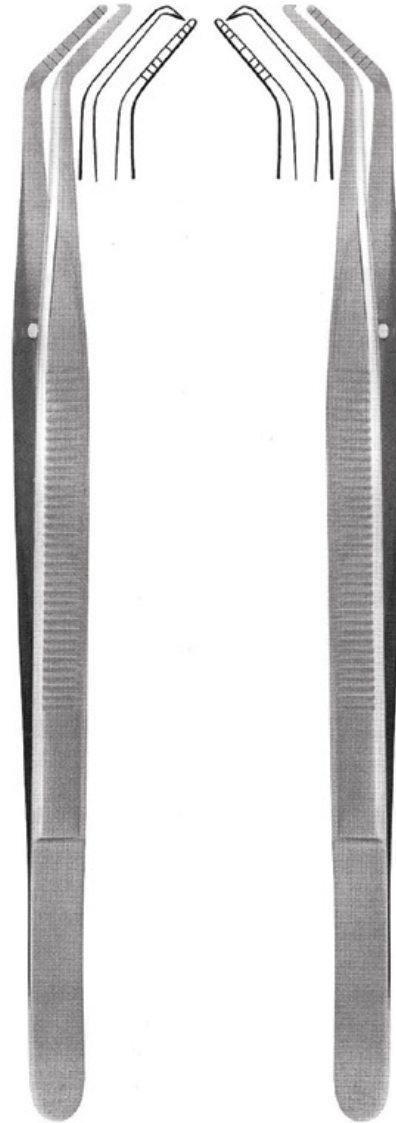

Crane-Kaplan
DI-04-165
Pocket markers

DI-04-166
Pocket markers

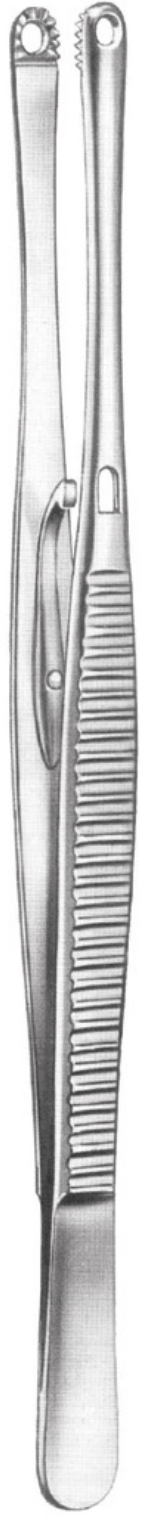

DI-04-167
with lock, 20 cm



Endontonic Instruments

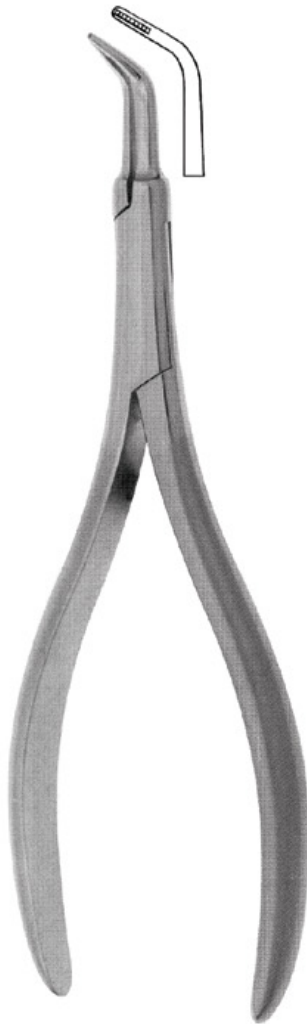

DI-04-168
13.0 cm
for root pins

Pliers for Broken Broaches

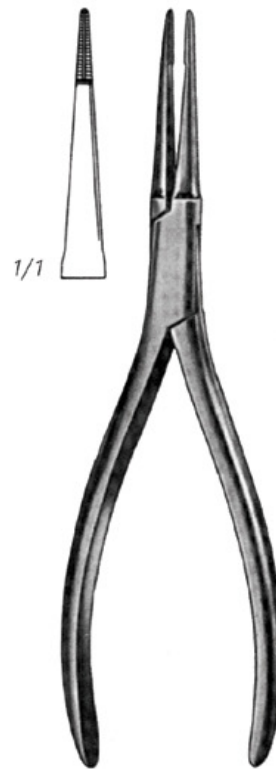

DI-04-169
13.0 cm